

ED2 SERIES

DEVICES

EKRASMS-SP software package manual

Version 7.1.1.1 and higher

Version EKRASMS-SP 3.0.235.25913 and higher

EKRA.00019-01 34 02

Copyright © RPE Ltd EKRA 2023. All rights reserved.

The disclosure, duplication, distribution and editing of this document, or utilization and communication of the content are not permitted, unless authorized in writing. All rights, including rights created by patent grant or registration of a utility model or a design, are reserved.

Document code: EKRA.00019-01 34 02

Edition: 05.2023

The predefined users and default passwords are shown in Table 1.

Table 1 – Default users and passwords

Default User	Login	Password
Administrator	admin	0100
Protection and control engineer	engineer	0200
Operator	operator	0300



NOTICE

In order to ensure information security, it is recommended to change the default passwords before operation start.

In case of password loss one shall inform the manufacturing enterprise.

Contents

1 Introduction	5
1.1 Purpose of this manual.....	5
1.2 Target audience	5
1.3 Purpose and scope of EKRASMS-SP software package.....	5
1.4 Software installation	5
1.5 Minimum system requirements for functioning of EKRASMS-SP software package	6
1.6 Related documentation	7
1.7 Support	9
1.8 Address of manufacturer	9
1.9 Training.....	9
1.10 Safety.....	9
2 Description of Smart Monitor interface.....	11
3 Description of work with the Smart Monitor program.....	30
3.1 User administration	30
3.2 Replacement of device configuration and software	33
3.3 Display of actual values.....	35
3.4 Tools.....	48
3.5 Service menu	53
3.6 Tests.....	59
3.7 Settings.....	64
3.8 Saving settings report.....	111
3.9 Writing settings.....	111
3.10 Updating settings.....	111
3.11 Saving data report via IEC 61850-8-1 protocol.....	111
3.12 Generating signals list via Modbus	111
3.13 Generating settings report in Excel.....	113
3.14 Generating signals list for transmission via OPC protocol.....	114
3.15 Generating signals list for transmission via IEC 60870-5-103 protocol	115
3.16 Generating signals list for transmission via IEC 60870-5-104 protocol	116
3.17 Importing settings.....	116
3.18 Generating files to send.....	117
3.19 Possible failures	117
4 Description of Configurator interface	118
5 Description of work with Configurator program	123
5.1 Description of Configurator editions.....	123

5.2 Opening, saving project configuration.....	124
5.3 Hardware part	126
5.4 Logic part	165
5.5 IEC 61850	195
5.6 Modbus client	201
5.7 Calculated values	204
5.8 User data.....	207
5.9 103 Protocol Master	208
5.10 Configuration parameters	209
5.11 Possible failures	212
6 Description of Health Monitor interface	214
Annex A Logical elements and their designation	232

1 Introduction

1.1 Purpose of this manual

The purpose of this manual is to describe the instructions for operating and configuring the ED2 series devices using the EKRASMS-SP software package.

1.2 Target audience

This manual is intended for relay protection engineers, specialists in commissioning, testing and maintenance of protection, automation and control devices, operating personnel of electrical installations of power plants and substations.

1.3 Purpose and scope of EKRASMS-SP software package

The Health Monitor program is designed to monitor the state of IEDs by such service signals as “In service”, “Error”, “Operate” and “Communication”. Health Monitor allows you to simultaneously monitor the state of several IEDs. Additionally, Health Monitor can download disturbance records of IEDs at specified intervals, send them by e-mail, and combine disturbance records manually or automatically. If necessary, it is possible to switch from Health Monitor to Smart Monitor for a detailed analysis of the state and settings of the selected IED.

Smart Monitor program allows you to do the following:

- view the current state of functions, measurements and state of logic in real time;
- change settings and parameters of IEDs;
- update software, configurations and licenses of IEDs;
- view and download disturbance records, event records, reports, etc.;
- test and diagnose IEDs;
- and debug logic in the Emulation mode.

When viewing disturbance records in Smart Monitor, a separate dedicated Waves software is automatically launched. Waves features include:

- construction of vector diagrams;
- harmonic analysis of signals;
- arithmetic operations with signals;
- combining several disturbance records into one.

Configurator program is intended for editing configurations of ED2 devices.

1.4 Software installation

To download the installation file, open your web browser and go to:
<https://soft.ekra.ru/smssp/downloads/software/SMForeign/?LANG=en>.

Click **Download** to download the setup file. Wait for the download to finish.

Run the downloaded installation file on your computer, the installation language selection window will open (Figure 1). Depending on your Windows OS settings, you may need permission to run, in which case contact your system administrator.

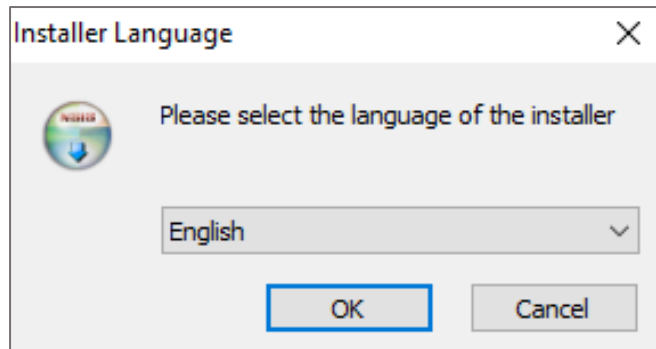

Figure 1 – Installation language selection window

Follow the instructions on the screen, the installation process will start after clicking the **Install** button. During installation, all necessary components of the EKRASMS-SP software package will be installed. When installation is complete, click **Finish** to exit the installer.

1.5 Minimum system requirements for functioning of EKRASMS-SP software package

a) operating systems:

- Windows Vista SP1 or later version;
- Windows Server 2008 (not supported as server's main role);
- Windows Server 2008 R2 (not supported as server's main role);
- Windows Server 2012 R2 (not supported as server's main role);
- Windows 7;
- Windows 8;
- Windows 8.1;
- Windows 10;

b) supported architectures:

- x86;
- x64;

b) hardware requirements:

1) 1.7 GHz processor or faster, 2 GB (for 32-bit system) or 4 GB (for 64-bit system) or more RAM;

2) minimum required space on HDD:

- x86 – 850 MB;
- x64 – 2 GB;

r) preliminary requirements:

- Internet Explorer 6 or later, Mozilla Firefox, Google Chrome;
- Microsoft Office 2003 or later.

1.6 Related documentation

At different stages of the life cycle of the ED2 series devices, appropriate documentation may be required. The list and title of the documentation covering a certain life cycle (Figure **Ошибка! Источник ссылки не найден.**):

- certification guide. The certification manual contains the entire list of current certificates and requirements that the ED2 series devices comply with;
- catalog of device types. The catalog of standard versions of devices contains all the necessary information for planning and purchasing. Contains a description of the functions and application of each specific device of the ED2 series;
- operation manual for a series of devices. The operation manual for a series of devices describes the basic principles of operation, actions for the operation and installation of devices of the ED2 series;
- operation manual for a specific device version. The operation manual for a specific version of the device contains basic information about the installation and mounting of the device, technical data, permissible values of inputs and outputs, conditions for preparing the device for operation;
- EKRASMS-SP software package manual. The manual for the software complex “EKRASMS-SP” describes the basic principles of working with the applied software of the ED2 series devices;
- Waves software manual. The manual for working with the Waves software contains complete information on working with disturbance records and their analysis;
- communication, time synchronization and network redundancy protocols manual. The communication, time synchronization and network redundancy protocol manual includes a description of communication protocols, time synchronization protocols and methods for organizing network redundancy in the ED2 series devices;
- online materials and YouTube video tutorials. Online materials and video tutorials on YouTube, available around the clock on the Internet, describe the basic operations for working with application software, operation and operations with the functionality of devices.

	Planning and purchase	Engineering	Mounting	Commissioning	Operation	Maintenance	Decommissioning
 Certification Guide	Active	Inactive	Inactive	Inactive	Inactive	Inactive	Inactive
 Catalog of device types	Active	Active	Inactive	Inactive	Inactive	Inactive	Inactive
 Operation manual for a series of devices	Active	Active	Active	Active	Active	Active	Active
 Operation manual for a specific device version	Active	Active	Active	Active	Active	Active	Active
 EKRASMS-SP software package manual	Inactive	Active	Inactive	Active	Active	Active	Inactive
 Waves software manual	Inactive	Inactive	Inactive	Active	Active	Active	Inactive
 Communication, time synchronization and network redundancy manual	Inactive	Active	Active	Active	Active	Inactive	Inactive
 Online materials and Youtube video tutorials	Active	Active	Active	Active	Active	Active	Active

Figure 2 – Use of documents at different stages of the life cycle for the ED2 series devices

1.7 Support

Manufacturer's website	https://ekra.ru/	
E-mail	support@ekra.ru	-
Software support page	http://soft.ekra.ru/smssp/en/downloads/software/	-
Operational documentation	http://soft.ekra.ru/smssp/en/downloads/documents/	
Video tutorials on working with ED2 series devices	https://www.youtube.com/playlist?list=PLSHLRtVG8WJeMyAaG0t-NibkO_r2eyJimN	

1.8 Address of manufacturer

Address: STE 541, 3 Yakovlev prospect, Cheboksary, Chuvashia - Chuvash Republic, 428020, Russia.

E-mail: ekra@ekra.ru
ekra3@ekra.ru

1.9 Training

KRA Training Center implements advanced training programs for products manufactured by EKRA Group and their applications at the facilities. Requests for training courses should be sent to:

Address: 3 Yakovlev Prospect, Cheboksary, Chuvashia – Chuvash Republic, 428020, Russia.

E-mail: training@ekra.ru

1.10 Safety

1.10.1 Warnings

This user manual uses a warning symbol to advise the user to be careful when performing certain operations.

	NOTICE	A situation that is not dangerous to life and health, but fraught with other undesirable consequences, for example, losses
---	---------------	--

1.10.2 Instructions

In the event of questions or problems, no further action should be taken without obtaining the required approval of the manufacturer. In this case, in order to obtain required information, it is necessary to send a corresponding request to the technical department of the company.

Only professionally trained and instructed personnel may be allowed to work with the device. Improper handling of the device and non-observance of safety measures can be dangerous for the operating personnel.

2 Description of Smart Monitor interface

The Smart Monitor program uses a graphical user interface.

Graphical user interface is multi-window with support of Drag&Drop technology, in which there is one main window, containing several child windows. Child windows contain main functionality of the software. The main window contains the main menu and toolbar.

This section contains the description of graphical interface of the program and its main elements.

1.1 Functionality of the Smart Monitor program

The Smart Monitor program is designed for:

- operating the ED2 series devices online;
- viewing current values of analog signals;
- displaying current and voltage phasor diagrams;
- viewing the state of binary signals;
- viewing, changing device settings and parameters;
- saving all device parameters and events in external files;
- viewing the event recorder;
- downloading disturbance records;
- viewing the state of logic.



1.2 Start

Before starting the Smart Monitor program, you must connect the device to the PC using an available communication channel.

The software is started using menu **Start**. To work with multiple devices at the same time, it is necessary to run a separate instance of the program.

1.3 Program termination

The program is terminated using standard methods for Windows applications:

- ALT+F4 key combination;
- via menu  → **Exit**;
- by clicking  on the title bar of the main window.

1.4 Logging in

After starting the Smart Monitor program, the **Connection to IED** window is displayed on the screen. The window (Figure 3) consists of three tabs:

- TCP/IP. This tab makes it possible to connect to the device via Ethernet automatically or manually. You can also select from the list of previously connected devices. To connect manually, enter the device's IP address and press the **Connect** button. For automatic connection, press **Search for IEDs in**

local network, select the necessary device from the list that appears and press the **Connect** button (Figure 3);

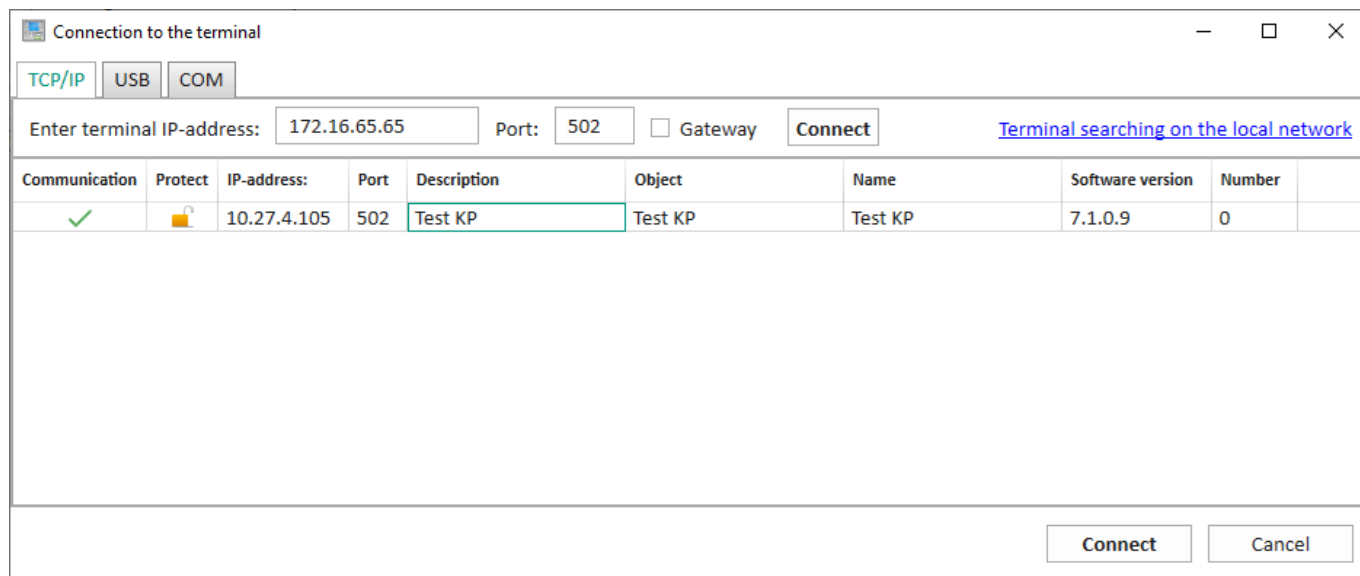

Figure 3 – **Connection to IED** window

– **USB**. This tab automatically searches for devices connected via USB. To connect, select a device from the list and click the **Connect** button (Figure 4);

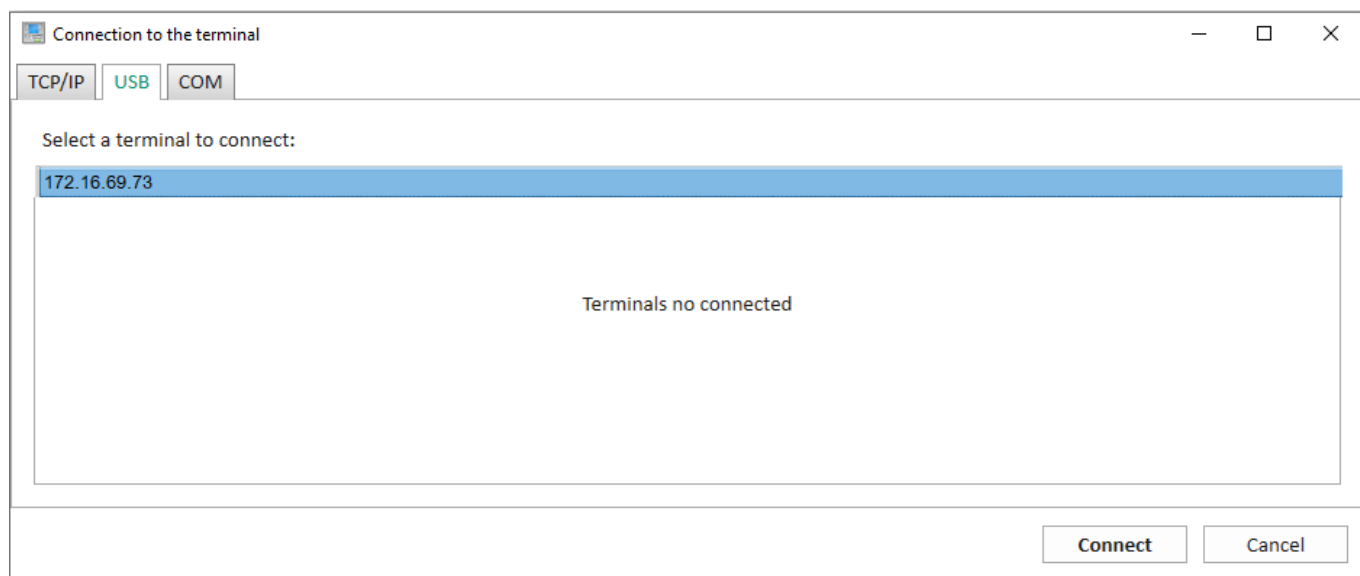

Figure 4 – **USB** tab

– **COM**. This tab (Figure 5) makes it possible to connect to the device via the COM port. To connect it is necessary to do the following:

- 1) select a COM port and the port speed from the drop-down list;
- 2) click on the **Search** button;
- 3) select the required device and click the **Connect** button.

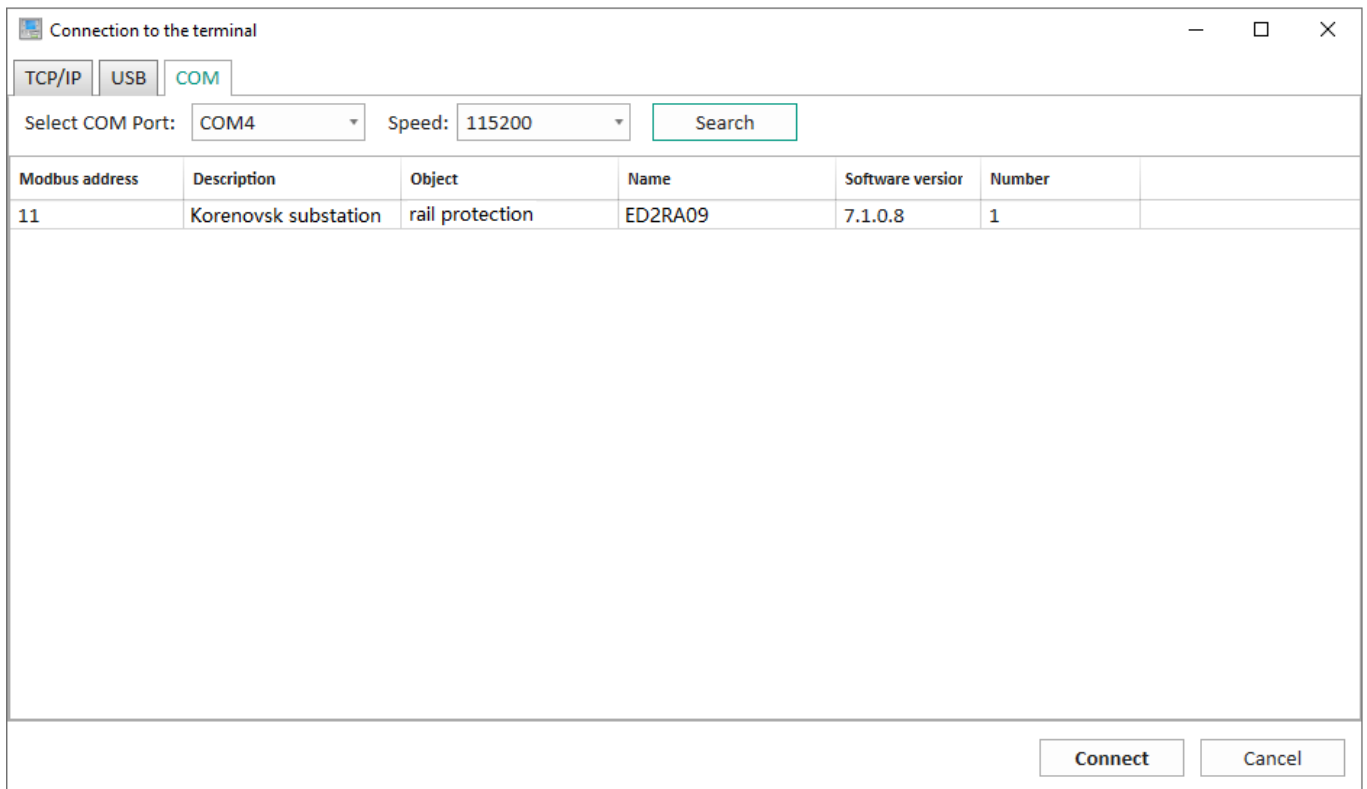

Figure 5 – **COM** tab

After connecting to the device, a standard program window is displayed on the screen (Figure 6). The standard window contains the following elements:

- title bar (item 1);
- main menu (item 2);
- toolbar (item 3);
- bottom toolbar (item 4);
- device “tree” (item 5);
- work area (item 6);
- right toolbar (item 7).

The title bar displays the name of the device, the IP address of the connected device, and buttons for collapsing, expanding, and closing the window. The bottom toolbar contains information about the operation mode, the left one contains the “tree” of the device.

The work area of the main program window (Figure 6, item 6) contains brief information about the device, the right part (Figure 6, item 7) contains general information about the device, its state and connection.

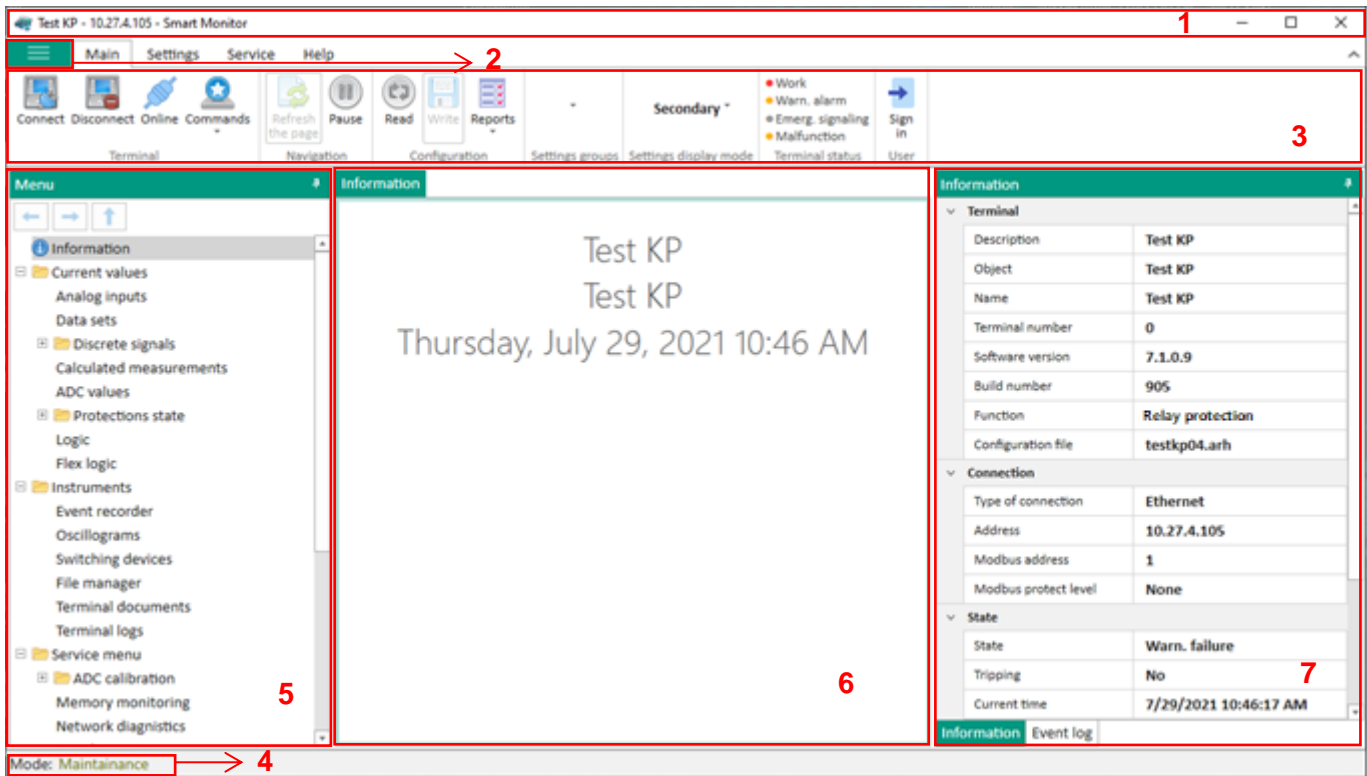

Figure 6 – Standard window of the program

Without user authentication, the use of some program functions is unavailable (Figure 7).

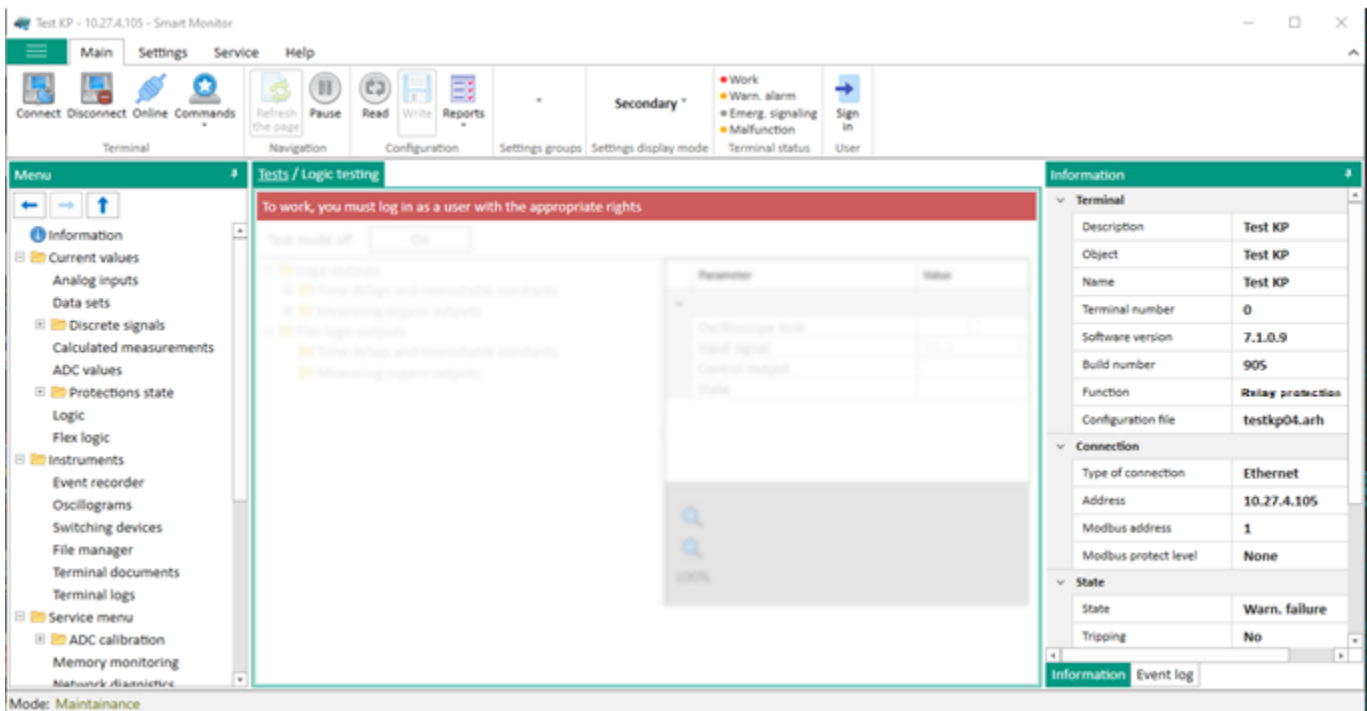



Figure 7 – Use of the program without authentication

To authenticate the user, click button . The user authentication form is shown in Figure 8.

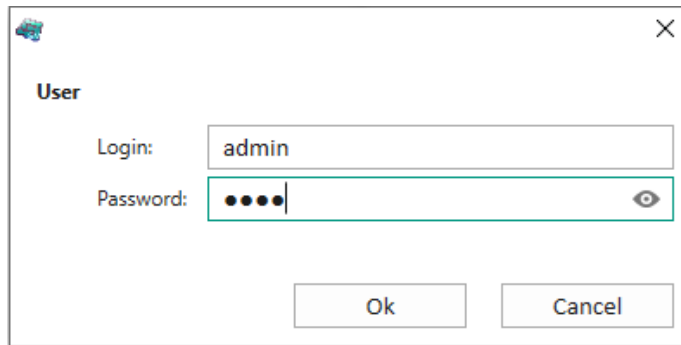

Figure 8 – User authentication form

In order to log in, you must enter a login and a password.

Each user has corresponding access rights. The access rights are assigned by the administrator.

If incorrect data is entered, a message is displayed (Figure 9). The user with administrator rights can add, remove, and edit user rights (subsection 3.1).

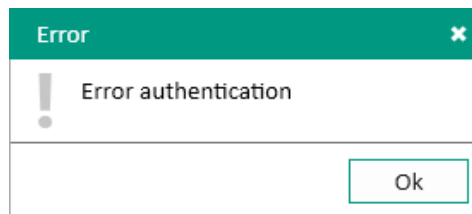

Figure 9 – Error window

1.5 Title bar of the main window

The title bar of the main window consists of the following elements (Figure 10):

- buttons of system menu;
- program name;
- device name;
- device IP-address.



Figure 10 – Title bar of the main window

1.6 Main menu

The main menu is located under the title bar of the main window and looks as follows  .

The main menu is linked to the submenu (Figure 11). The submenu appears when you press the left mouse button on a menu item.

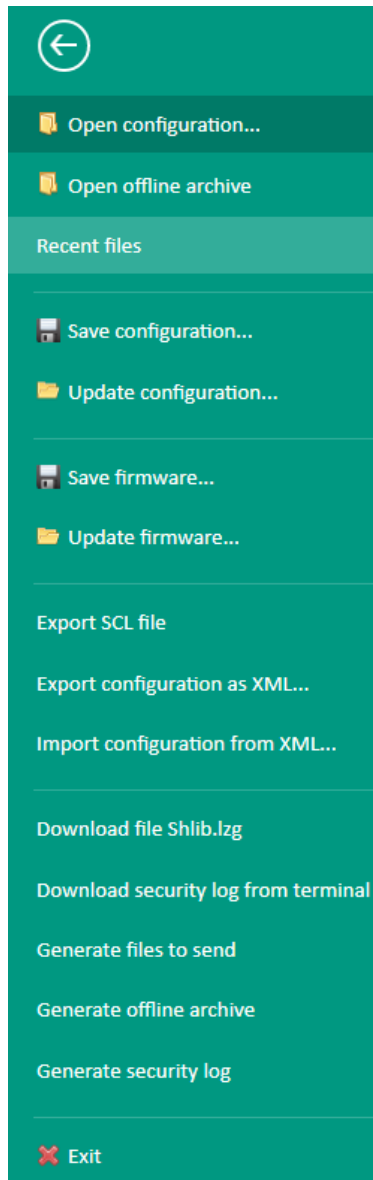

Figure 11 – Submenu of the main menu

Commands of the main menu and their functions are shown in Table 2.

Table 2 – Commands of the main menu

Command	Function
Open configuration...	Opening the existing device configuration
Open offline archive	Opening the existing archive
Recent files	Displaying and opening recent projects
Save configuration...	Saving the existing device configuration
Update configuration...	Updating device configuration
Save software...	Saving the existing device software
Update software...	Updating the device software
Export SCL file	Exporting SCL file *.cid, *.icd

Command	Function
Export settings as xml...	Exporting device settings as an xml file
Import settings from xml...	Importing settings from an xml file to the device
Download Shlib.lzg file	Saving the Shlib.lzg file (library file) of the device to the computer
Download security log from IED	Saving the information security event log of the device to the computer
Generate files to send	Saving the files to send to the computer
Generate offline archive	Generating an archive file
Generate security log	Generating an information security event log of the Smart Monitor program
Exit	Exiting the Smart Monitor program

The command associated with the corresponding menu item is activated by pressing the left mouse button on the menu item. An icon (displayed to the left of the menu command name) can be associated with the command.

1.7 Toolbar

The toolbar provides an alternative way to access frequently used commands. It consists of the **Main**, **Settings**, **Service** and **Help** tabs and looks as follows (Figures 12-15):

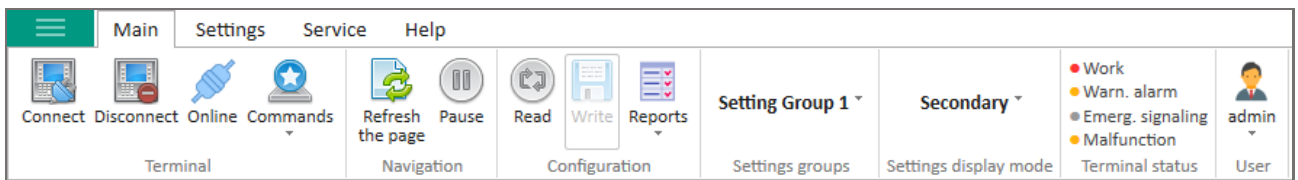

Figure 12 – Main tab

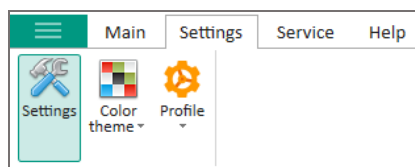

Figure 13 – Settings tab

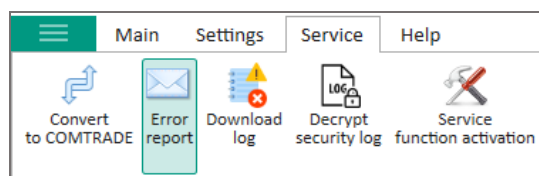





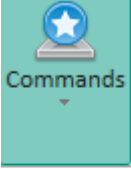





Figure 14 – Service tab













Figure 15 – Help tab

Commands available on the toolbar commands are shown in Table 3.

Table 3 – Toolbar commands

Icon	Name
Main tab	
 Connect	Connect to the device
 Disconnect	Disconnect from the device
 Online , Offline	Communication with the device is present/absent
 Commands Start oscillography Reset alarms Setup date and time	Execute a command: <ul style="list-style-type: none"> - Start oscillography; - Reset alarms; - Set divice date and time.
 Refresh the page	Refresh current page
 Pause	Pause page refresh
 Read	Read configuration from the device. All unsaved changes will be lost
 Write	Write settings to the device
 Reports	Generate a report on settings and communication protocols
Setting Group 1 ▾	Selecting setting group
Secondary ▾	Selecting the mode of displaying settings

Icon	Name
<ul style="list-style-type: none"> ● Work ● Warn. alarm ● Emerg. signaling ● Malfunction Terminal status 	Device state
 admin	User. It contains a list of submenus: <ul style="list-style-type: none"> – User administration; – Change a password; – Exit
Settings tab	
 Settings	Program settings
 Color theme	Color theme
 Profile	Active profile
Service tab	
 Convert to COMTRADE	Conver disturbance records to COMTRADE
 Error report	Error report
 Download log	Download a log
 Decrypt security log	Decrypt an IS log
 Service function activation	Activation of service functions
Help tab	
 About	Information about the program

Note – The **Activate service functions** command is available only after entering the activation key of service functions.

1.7.1 Home tab

The **Commands** menu includes the following elements:

- start disturbance recorder. The command is intended for manual start of disturbance recorder on the device. The command execution window is shown in figure 16;

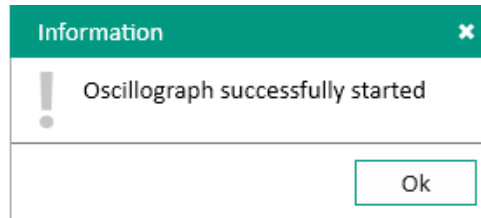

Figure 16 – **Start disturbance recorder** command window

- reset alarm. The command is intended to reset the state of latching signals for LEDs, relays, the state of output signals of latching logic for transmission to the PCS. The command execution window is shown in figure 17;

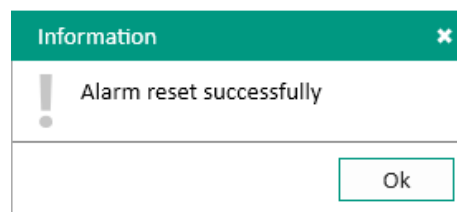

Figure 17 – **Reset alarm** command window

- set date and time. The command window is shown in figure 18. When setting the date and time, you must enter a password.

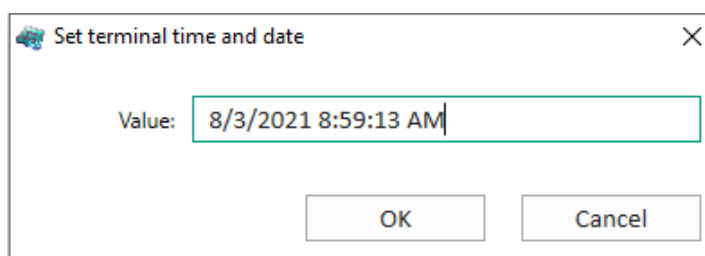

Figure 18 – **Set time and date** command window

The **Reports** menu contains a list of submenus for generating various types of reports (table 4).

Table 4 – List of the **Reports** command submenus

Icon	Description
Settings report	Generation of a report on settings in TXT format
Settings report in Excel	Generation of a report on settings in Excel format
Modbus data description	Generation a list of signals for data transmission via Modbus protocol in Excel format

Icon	Description
List of signals in PCS (OPC identifiers)	Generation of a list of signals for data transmission via OPC protocol in Excel format
IEC 60870-5-103 protocol data	Generation of a list of signals for data transmission via IEC 60870-5-103 protocol in Excel format
IEC 60870-5-104 protocol data	Generation of a list of signals for data transmission via IEC 60870-5-104 protocol in Excel format
IEC 61850-8-1 protocol data	Generation of an Excel file with a list of signals transmitted via IEC 61850-8-1 protocol
Settings sheet	Generation of a settings sheet
Modbus parameters in xml	Generation of Modbus parameters

1.7.2 Settings tab

The **Settings** command window consists of two tabs. The description of parameters is shown in table 5.

Table 5 – Description of parameters of the **Settings** command

Parameters	Description
General tab (figure 19)	
Auto connect upon start	Select Auto connect when starting the Smart Monitor program. The connection is made to the device with which communication was carried out during the last session
Send statistics and errors to developers	Selection of sending statistics and errors to developers
Show “Information” panel	Selection of display of the “Information” panel
Interface scale	Selection of the interface scale
Program language	Selection of the program language. The following languages are available: – Ru (Russian); – En (English)
Disturbance record viewer	Selection of the viewer of disturbance records
IEDs 2xx tab (figure 20)	
Expand logic for protections	Selection of expanding logic for protections (the Logic menu item will contain sub-items corresponding to the frames in the general diagram)
Disable advanced file transfer features via Modbus	Disable advanced Modbus file transfer features (used for compatibility with protocol converters)
Create and edit profiles	Create and edit profiles

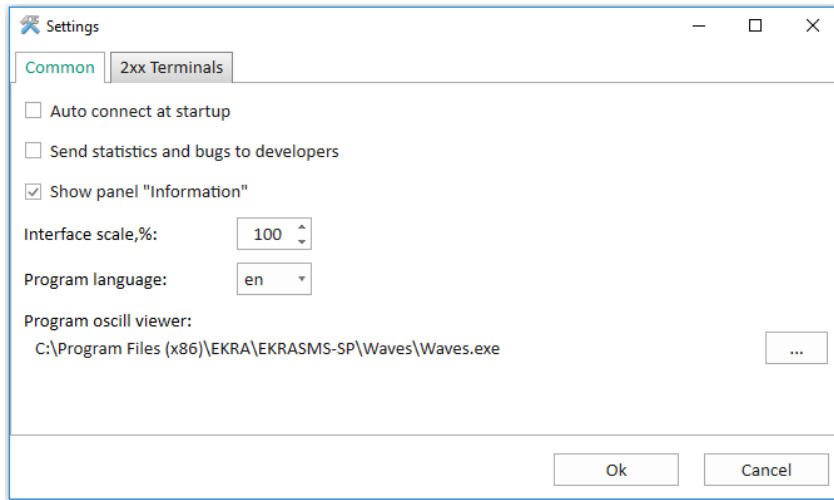

Figure 19 – General tab

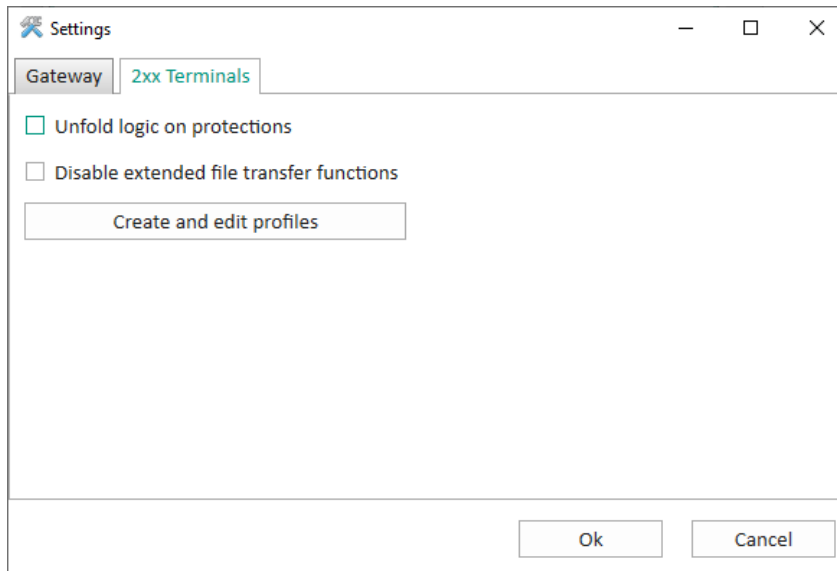



Figure 20 – IEDs 2xx tab

The **Create and edit profiles** command (figure 21) allows adding and deleting profiles using buttons  and . Methods for editing the device tree menu are presented in table 6.

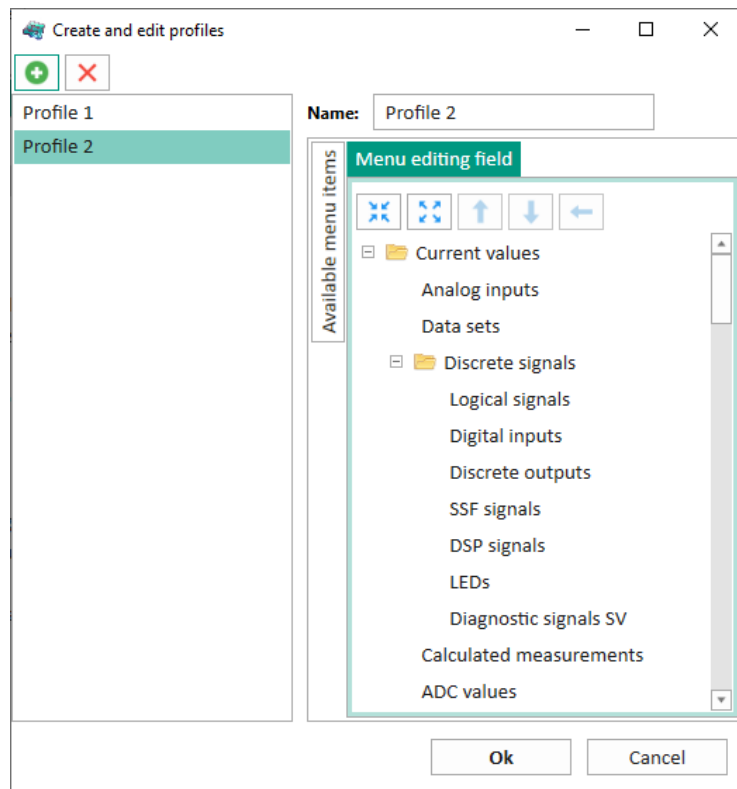

Figure 21 – Create and edit profiles window

Table 6 – Methods for editing the menu field

Icon	Description
	Minimize the menu
	Maximize the menu
	Move the item up
	Move the item down
	Move one level up

The **Color theme** command (**Settings** tab) is used to select the program theme. The following color schemes are available:

- Dark 1;
- Dark 2;
- Light;
- Grey 1;
- Grey 2;
- Blue.

Using the **Profile** command (**Settings** tab), it is possible to select a device tree profile that will be used when Smart Monitor is running.

1.7.3 Service tab

The **Convert to COMTRADE** command is used to convert disturbance records from the internal format to the Comtrade format.

You can use the **Error report** command to report a bug in the Smart Monitor program or a suggestion for improving Smart Monitor. To do this, it is necessary to fill out the form (figure 22).

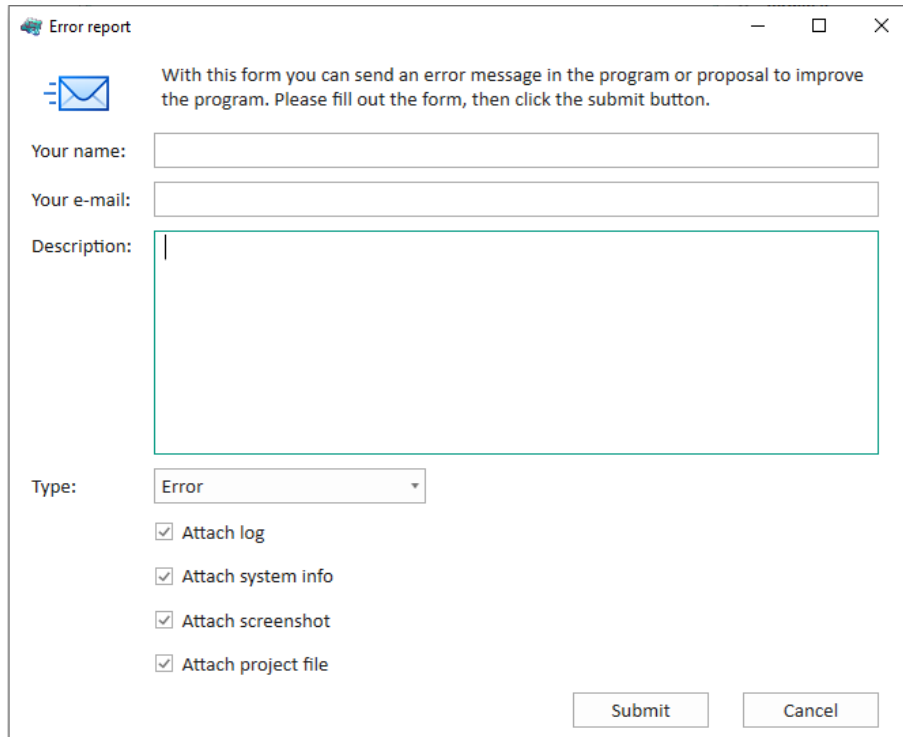

Figure 22 – **Service** tab

The **Download log** command allows saving log files maintained by the Smart Monitor program as an archive in *.zip format.

The **Activate service functions** command after entering the registration key allows you to access additional tools (for example, **Memory card**, **File manager**, **IED logs**, etc.).

1.7.4 Help tab

Using the **About** command you can obtain brief information on this program (figure 23).

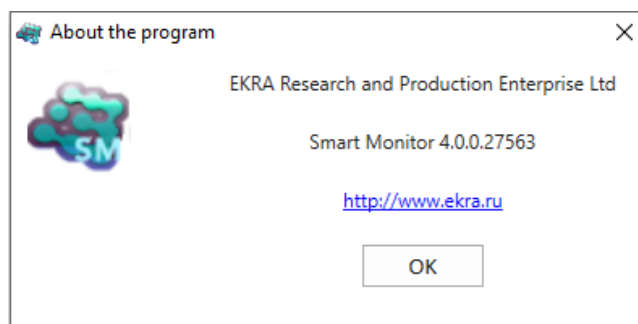

Figure 23 – **About** command window

1.8 Status bar

The status bar (figure 24) is located in the lower part of the main window.

By default, the status bar displays information on the mode. The following operating modes are provided for the device:

- No connection – mode in which there is no connection to the device;
- Adjustment – mode with extended functionality;
- File – mode when opening a configuration file or opening an offline archive.

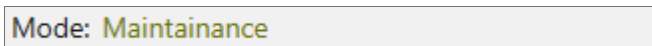



Figure 24 – Status bar

1.9 Function windows

Function windows are the main window's child windows which are opened when selecting the elements in the device tree.

Function windows may contain additional panels (pop-up windows), which can be hidden via context menu of windows. They can also be embedded in various parts of the function window (right, left, top, bottom, etc.) by dragging through the window titles (figure 25). To the right of the title, pop-up windows have a button , that can be used to minimize the window.

Options for setting the user interface make it possible to arrange program windows and panels in the most convenient way.

The Drag&Drop technology allows the user to adjust the size of program windows using the mouse. To perform this operation, move the mouse pointer to the border of the target window until the shape of the mouse pointer changes to a double-sided arrow. From now on, you can resize by pressing the left mouse button and moving it in the desired direction. Then release the left mouse button.

Arrangement of windows can be changed using mouse by dragging the window by its title or using functions of the system menu.

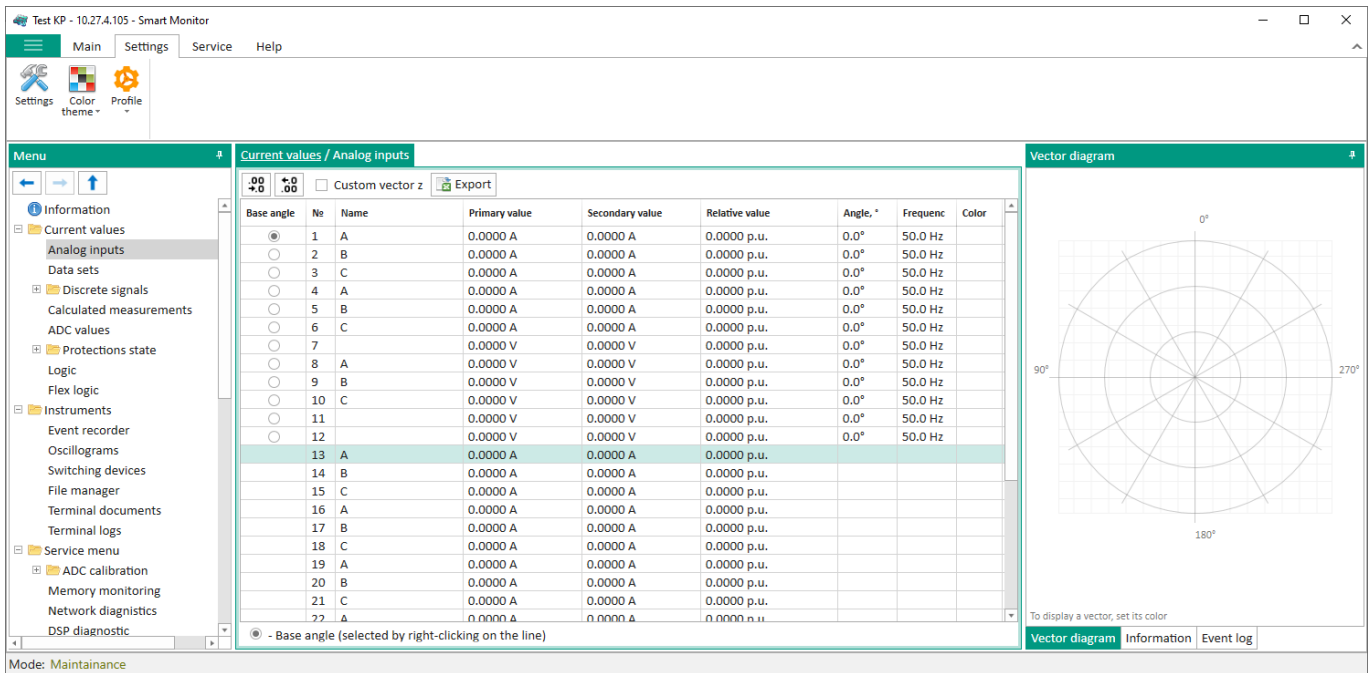





Figure 25 – Example of a function window

1.10 Menu panel of the device

The menu window of the device is located in the left part of the program window. The default tree menu for the ED2 series devices is shown in figures 26, 27. To go to the previous window or one level up, use buttons    respectively.

- [-] Current values
 - Analog inputs
 - Data sets
 - [-] Discrete signals
 - Logical signals
 - Digital inputs
 - Discrete outputs
 - SSF signals
 - DSP signals
 - LEDs
 - Diagnostic signals SV
 - Calculated measurements
 - ADC values
 - [-] Protections state
 - I
 - I3>
 - U1>
 - U2>
 - =I
 - dU / dt
 - =I f
 - 3I>BF
 - FPVN
 - I d (5)_IdG
 - Logic
- [-] Instruments
 - Event recorder
 - Oscillograms
 - Switching devices
 - Terminal documents
- [-] Service menu
 - [-] ADC calibration
 - Coefficients
 - Zero offsets
 - Network diagnostics
 - DSP diagnostic
 - Hardware configuration
 - Blocks diagnostic
- [-] Tests
 - Logic testing
 - Matrix inputs emulation
 - Logic emulation
 - Data set testing
 - LED testing
 - Relay testing
 - GOOSE testing
 - SV testing
- [-] Settings
 - Analog inputs
 - Digital inputs
 - Discrete outputs
 - LEDs
 - Calculated measurements
 - Indicated measurements
 - Switching devices
 - Calculated measurements parameters
 - Protection In/Out

Figure 26 – ED2 series device tree menu

- [-] Protects settings
 - [-] Group no
 - Parameters
 - Registration and Oscillography
 - Output table
 - LED table
 - Matrix of outages
 - [-] I
 - [-] I3>
 - [-] U1>
 - [-] U2>
 - [-] =I
 - [-] dU / dt
 - [-] =I f
 - [-] 3I>BF
 - [-] FPVN
 - [-] I d (5)_IdG
 - Differences in setting groups
- [-] Registration and Oscillography
 - Oscillography parameters
 - Analog inputs
 - Logical signals
 - Digital inputs
 - Calculated measurements
 - Matrix outputs
 - DSP signals
 - SSF signals
 - Incoming GOOSE
- [-] System parameters
 - Terminal options
 - Setting groups
- [-] Digital communication channels
 - Communication parameters
 - Reservation settings
 - Analog input parameters
 - Calculated measurements parameters
- [-] Time synchronization
 - Control
 - Parameters
 - SNTP
 - PTP
- [-] Communication protocols
 - Control
 - ModbusRTU
 - 60870-5-103
 - IEC103Master
 - ModbusTCP
 - 60870-5-104
 - [-] 61850
 - Parameters
 - Outgoing GOOSE
 - Incoming GOOSE
 - Incoming SV
 - Data sets
 - Report blocks
 - User data
 - Administration of management

Figure 27 – ED2 series device tree menu

The operations will be activated by selecting the corresponding element of the tree.

You can minimize/maximize the tree by clicking the right mouse button on the tree element and selecting the corresponding command (figure 28) or by double-clicking the left mouse button on the element. To open a menu/submenu in a new window, right-click on the element of the tree. Next, a copy of the application is launched with the installation of the selected menu item.

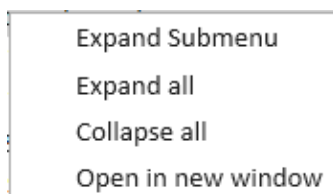





Figure 28 – Context menu of the tree

The tree provides the user with the ability to conveniently navigate between program modes. A single click of the left mouse button on an element opens the element in the current child window.

“Opening a tree element” means opening the content corresponding to the given tree element in a child window.

The tree elements are divided into two groups:

1) Mode group element, which contains a group of modes and function windows. It is a branch of the tree.

The purpose of the element is a logical grouping of modes. Each element is visually connected to the tree through icon  or . Icon  stands in front of a minimized group, and  – in front of a maximized one. Pressing the left mouse button on this icon will cause the corresponding group to minimize/maximize.

Opening this element in a child window is a listing of the contents of the group.

2) Mode element, which represents a specific mode of the program (function window). It is a leaf of the tree.

The purpose of the element is to activate the required mode of the program. Opening of this element is the opening of corresponding function windows.

3 Description of work with the Smart Monitor program

3.1 User administration

Administration of system users is intended for adding, changing, deleting users and groups, as well as setting access rights for user groups.

User administration is available only after administrator authentication.

The administration center window is opened by users from the main window with button  on the toolbar.

The window (figure 29) consists of three tabs:

- Users;
- Groups;
- Rights.

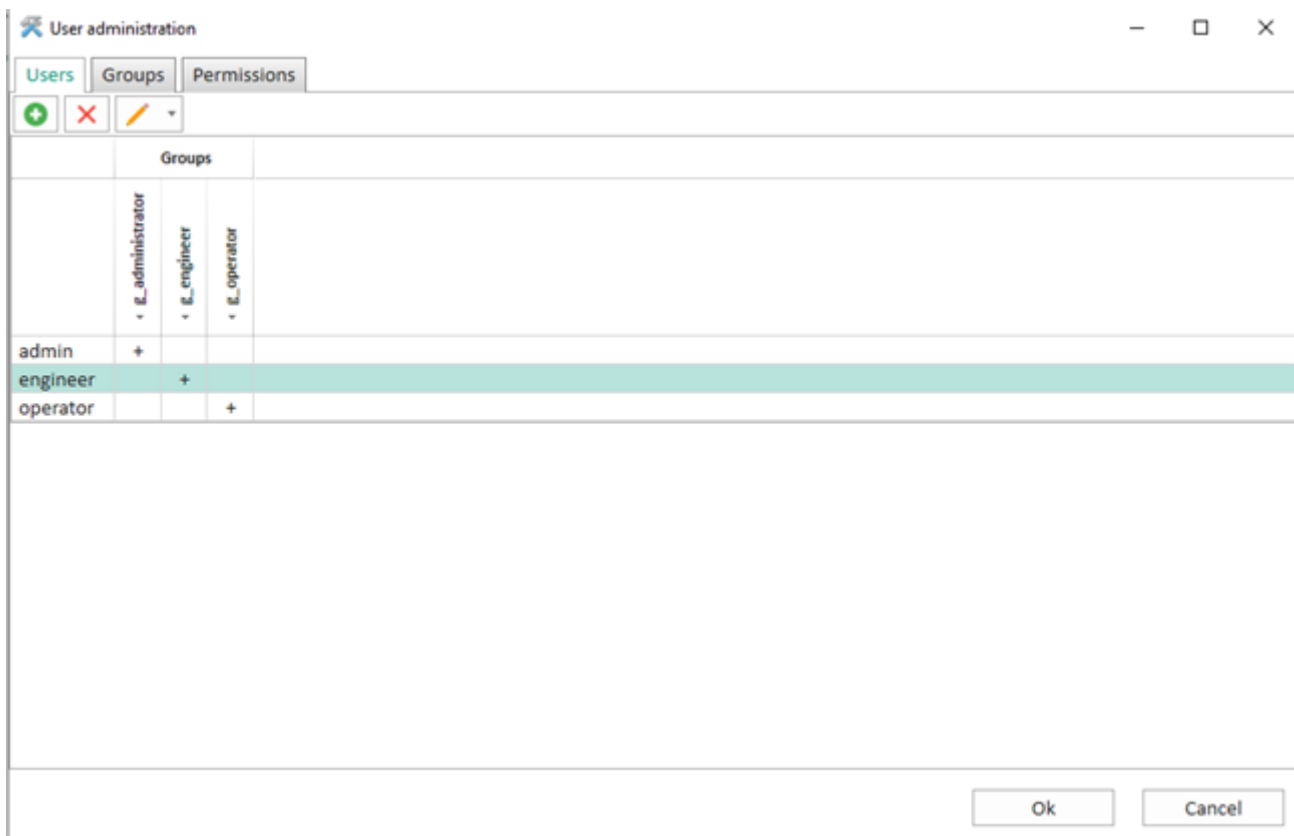

Figure 29 – User administration window

3.1.1 Users

Operations on user accounts are performed in this tab.

Operations are available via toolbar   .

Editing, deleting and changing user password are available only after selecting the corresponding user from the list.

Login can consist of the following characters: "A – Z", "a – z", "0 – 9", "_". The maximum quantity of login characters is 16. The password can only consist of characters "0 – 9". Quantity of password characters is 4 – 16.

A new user is added by pressing button . In this case, in the displayed window (figure 30) it is necessary to enter the data of the new user.

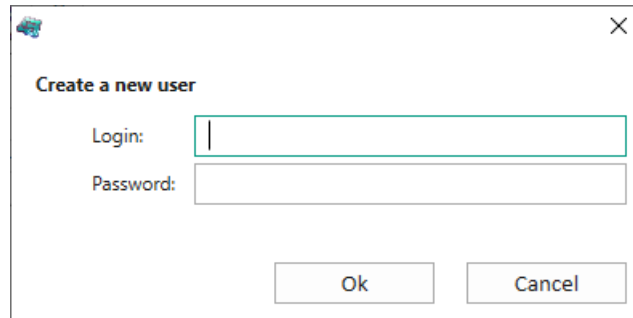



Figure 30 – **Create a new user** command window

A user is deleted by pressing button . A dialog box will appear to confirm deletion.

The password and the number of active sessions is changed by pressing button . In this case, in the displayed window (figure 31) it is necessary to enter a new password.

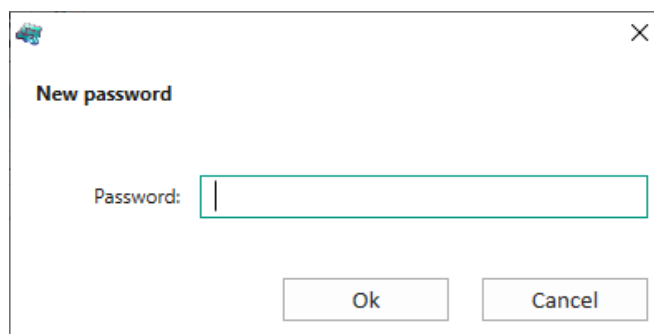

Figure 31 – **New password** command window

After entering a new password, it is necessary to enter the quantity of active sessions (figure 32). The **Set number of active sessions** command sets a limit on the maximum quantity of parallel sessions with the device.

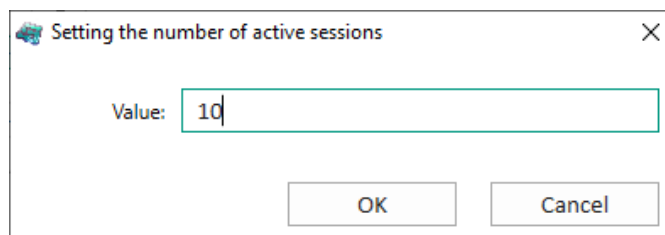

Figure 32 – **Set number of active sessions** window

Entering the password expiration date is shown in figure 33. In this case, in the displayed window, it is necessary to enter the quantity of days during which the password will be active. Quantity of days:

- 1) 0 – password never expires;
- 2) 999 – maximum value.

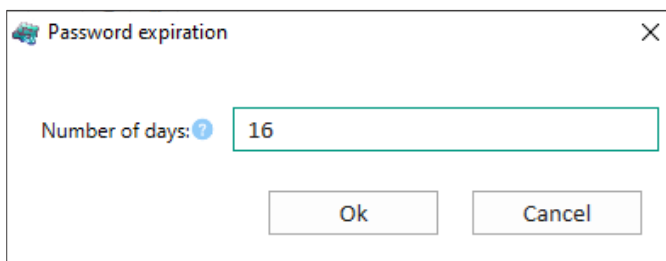



Figure 33 – **Password expiration** window

3.1.2 Groups

This tab is used to perform operations on groups.

Operations are available via toolbar  .

Editing and deleting a group is available only after selecting the corresponding group from the list. The name of the group can be edited by clicking the left mouse button on the name.

A new group is added by pressing button . In this case it is necessary to enter a name for the new group in the displayed window (figure 34). Once added, the new group will appear on the **Users** and **Rights** tabs in the **Groups** column.

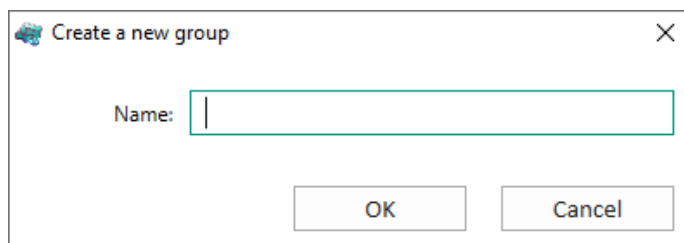
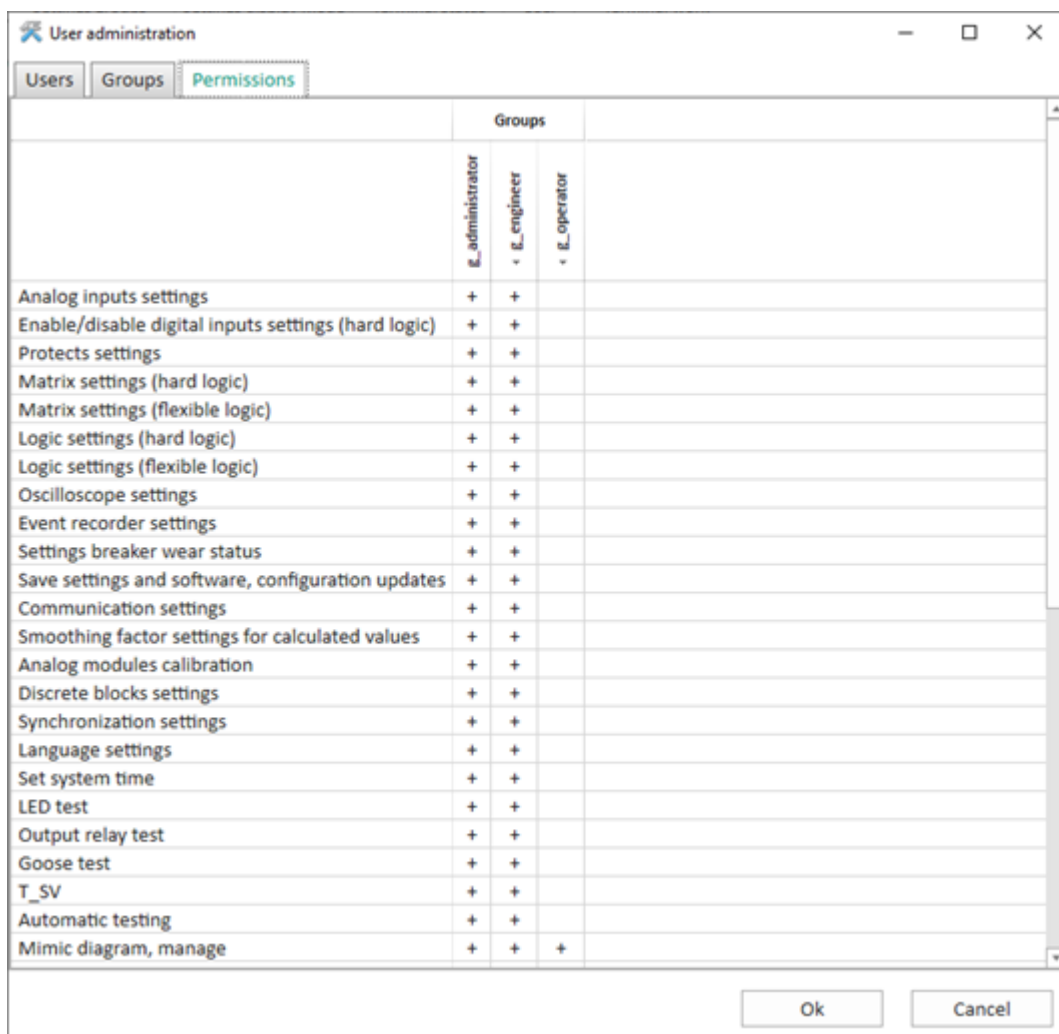

Figure 34 – **Create a new group** window

A group is deleted by pressing button  after excluding all users from the group. A dialog box will appear to confirm deletion.

3.1.3 Rights

This tab (figure 35) is designed for assigning permissions and access rights for user groups.



	Groups		
	E_administrator	E_engineer	E_operator
Analog inputs settings	+	+	
Enable/disable digital inputs settings (hard logic)	+	+	
Protects settings	+	+	
Matrix settings (hard logic)	+	+	
Matrix settings (flexible logic)	+	+	
Logic settings (hard logic)	+	+	
Logic settings (flexible logic)	+	+	
Oscilloscope settings	+	+	
Event recorder settings	+	+	
Settings breaker wear status	+	+	
Save settings and software, configuration updates	+	+	
Communication settings	+	+	
Smoothing factor settings for calculated values	+	+	
Analog modules calibration	+	+	
Discrete blocks settings	+	+	
Synchronization settings	+	+	
Language settings	+	+	
Set system time	+	+	
LED test	+	+	
Output relay test	+	+	
Goose test	+	+	
T_SV	+	+	
Automatic testing	+	+	
Mimic diagram, manage	+	+	+

Figure 35 – Rights tab

The permission is controlled by setting/clearing the pluses “+” in the cell of the rights table in the column of the required group.

3.2 Replacement of device configuration and software

Device configuration¹⁾ and software can be replaced only if you have the corresponding access rights (see 3.1.3). The device communication port used to work with Smart Monitor must have write permission.

¹⁾ Configuration file is a file of device software settings that contains a description of the hardware, set of functions, logic and mimic diagram.



NOTICE

Before replacing the configuration and software, it is necessary to take the device out of operation or prevent false influence of the device on external circuits!

3.2.1 Replacement of software

3.2.1.1 Start the Smart Monitor program and establish connection with the device.

3.2.1.2 Device software is replaced via menu item  → **Update software...** When you select this item (figure 11) a dialog box (figure 36) is displayed in which you must specify the path to the **core.arh** or **sh.rtb** file, then confirm the selection by clicking the **Open** button. If the version of the selected file is incorrect, a corresponding entry will appear in the dialog box.

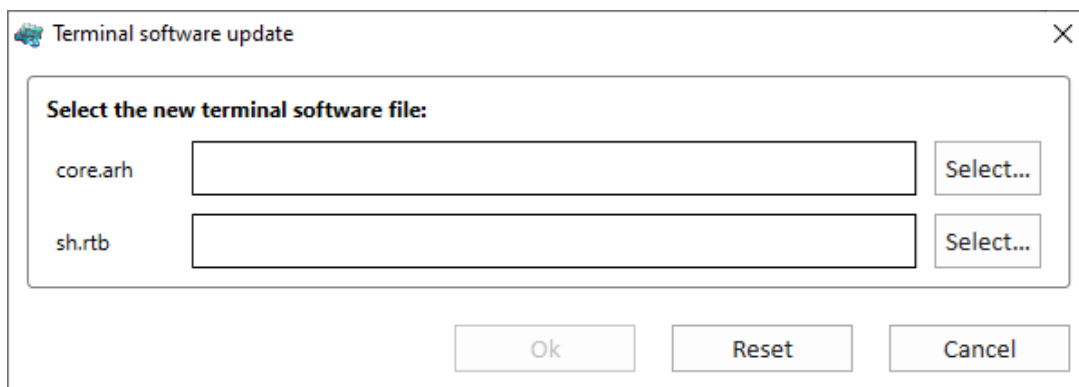

Figure 36 – IED software update window

3.2.2 Wait until the file is copied.

3.2.2.1 When copying is completed, an information window is displayed.

3.2.2.2 Restart the device by power supply.

3.2.3 Replacement of configuration

3.2.3.1 Start the Smart Monitor program and establish connection with the device.

3.2.3.2 Device configuration is replaced via menu item  → **Update configuration...** When this item is selected, a dialog box (figure 37) is displayed in which you must specify the path to the **xxxx.arh** configuration file. The name of the loaded configuration file must match the name of the configuration file on the device. If the configuration contains incorrect versions, an error message will be displayed.

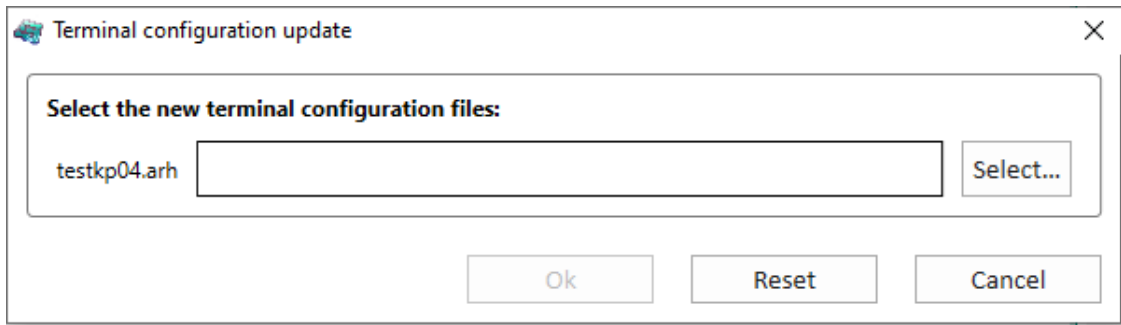

Figure 37 – IED configuration update window

3.2.3.3 Wait until the file is copied.

3.2.3.4 When copying is completed, an information window is displayed (figure 38).

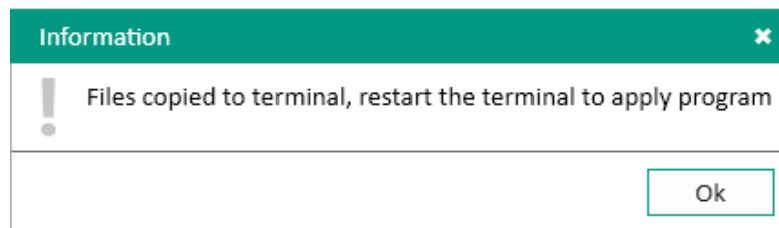

Figure 38 – Information window

3.2.3.5 Restart the device by power supply.

3.3 Display of actual values

3.3.1 Actual values of analog inputs

The **Analog inputs** window (figure 39), device tree menu **Actual values** → **Analog inputs**, is designed to display the actual values of analog inputs (circuits). The **Analog inputs** window consists of a table of measurements of circuit values and an additional window of phasor diagram.

By clicking the right mouse button on the required analog measurement, the base phasor (figure 39, item 1) is selected in the tab, relative to which current values of the angles of other phasors are calculated. When you press the left mouse button in the tab, other analog measurements are highlighted in green (figure 39, item 2). It is possible to decrease or increase the digit capacity of values using buttons



(figure 39, item 3).

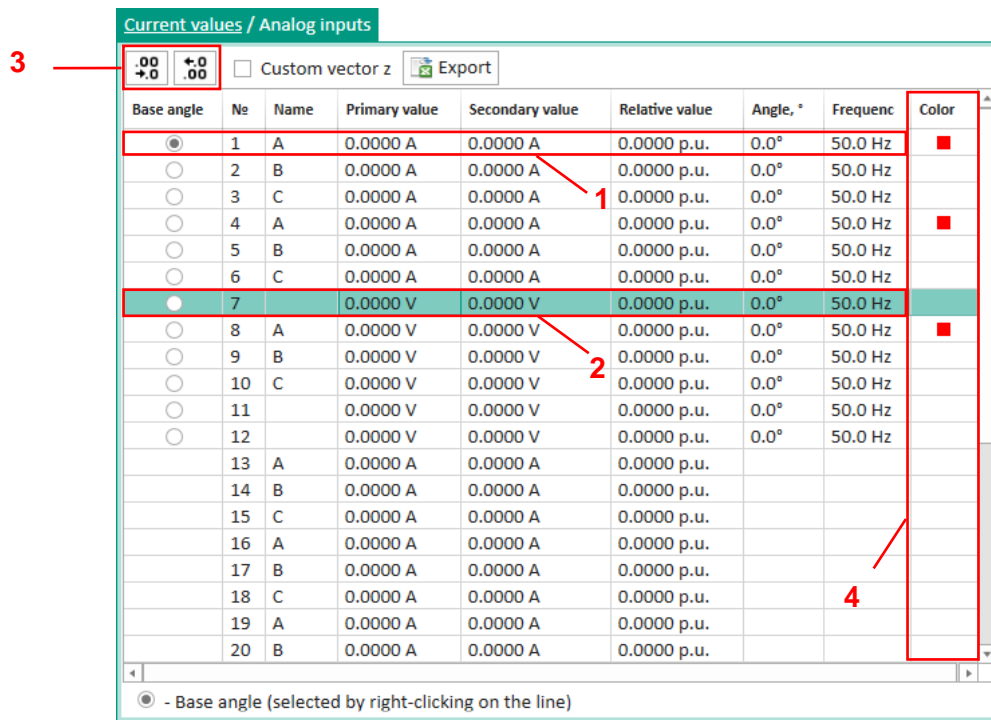



Figure 39 – Analog inputs window

Fields of the circuit value measurement table are shown in table 7.

Table 7 – Circuit value measurement table

Name	Designation
Base angle	Base angle, relative to which the calculation is made for other analog values
No.	Sequence number of the circuit
Name	Circuit name
Primary value	Secondary value of the analog signal multiplied by the transformation ratio
Secondary value	Values of current or voltage coming to analog inputs of the device
Relative value	Ratio of the actual value of the signal to its circuit rating
Angle, °	Phase angle of the analog signal relative to the base phasor, in degrees
Frequency	Frequency of a signal in Hz: – for frequency groups – measured frequency; – for zero frequency group – allocated frequency
Color	Phasor color on the phasor diagram

The phasor diagram is located on the right side of the **Analog inputs** window. Using button  it is possible to control location of the open **Phasor diagram** tab (figure 40) on the page. To display a phasor on a phasor diagram, you need to set a color for it (figure 39, item 4).

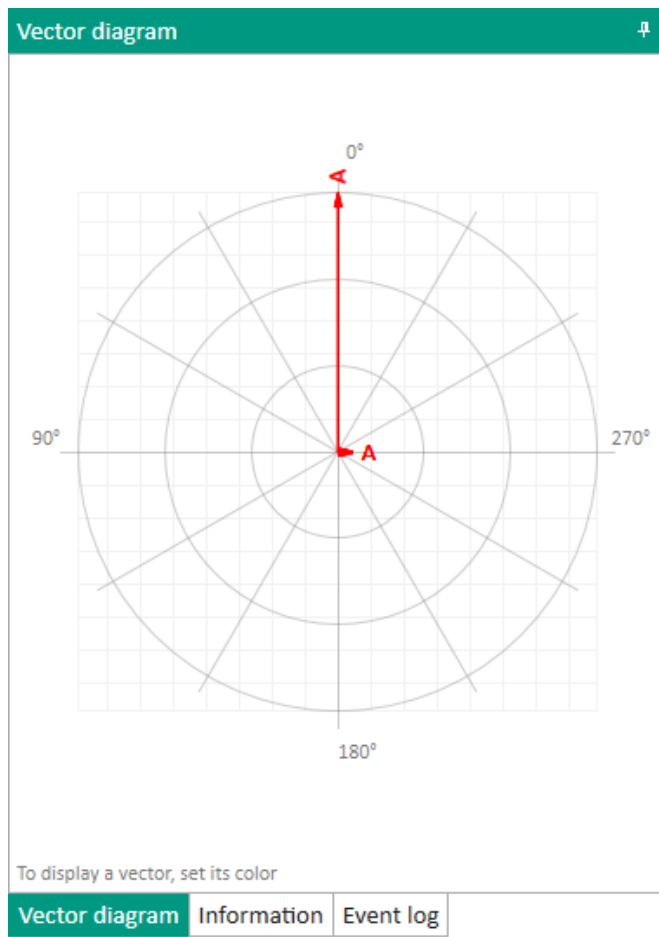

Figure 40 – Phasor diagram tab

3.3.2 Actual values of data sets

The **Data sets** window (figure 41), device tree menu **Actual values** → **Data sets**, is designed to display actual values of the specified data sets.

Current values / Data sets			
No	Name	Value	
▼ DT			
1	In service	1	
▼ AT			
1	A	0.0000 A	
2	B	0.0000 A	
3	C	0.0000 A	
4	A	0.0000 A	
5	B	0.0000 A	
6	C	0.0000 A	
7		0.0000 V	
8	A	0.0000 V	
9	B	0.0000 V	
10	C	0.0000 V	

Figure 41 – Data sets window

3.3.3 Actual values of binary signals

3.3.3.1 Logic signals

The **Logic signals** window (figure 42), device tree menu **Actual values** → **Binary signals** → **Logic signals**, is designed to display actual values of logic signals.

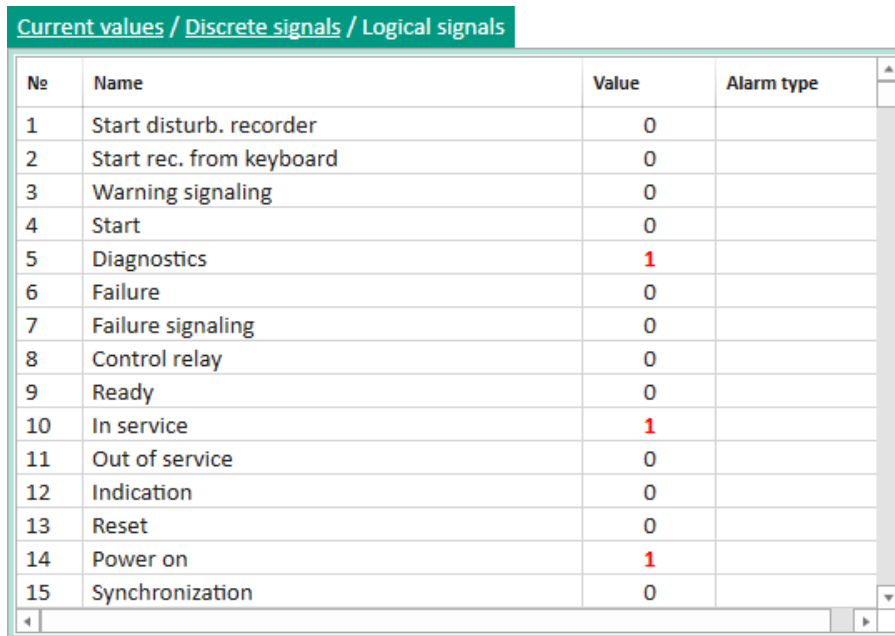

No	Name	Value	Alarm type
1	Start disturb. recorder	0	
2	Start rec. from keyboard	0	
3	Warning signaling	0	
4	Start	0	
5	Diagnostics	1	
6	Failure	0	
7	Failure signaling	0	
8	Control relay	0	
9	Ready	0	
10	In service	1	
11	Out of service	0	
12	Indication	0	
13	Reset	0	
14	Power on	1	
15	Synchronization	0	

Figure 42 – **Logic signals** window

The description of parameters of logic signals is given in table 8.

Table 8 – Description of parameters of logic signals

Parameter	Description
No.	Sequence number of the logic signal
Name	Name of the logic signal
Value	Current value of the logic signal
Alarm type	Alarm of the logic signal: – Warning alarm (yellow square); – Emergency alarm (red square); – No alarm

3.3.3.2 Binary inputs

The **Binary inputs** window (figure 43), device tree menu **Actual values** → **Binary signals** → **Binary inputs**, is designed to display actual state of binary inputs.

No	Name	Value
Hardware discrete inputs		
A-E2 (PU1602) Power and control module		
1	Ready	0
2	Work	1
3	Out of work	0
4	Call	0
5	Reset	0
A-E9 (EI2582) Binary inputs module		
1		0
2		0
3		0
4		0
5		0
6		0
7		0
8		0
9		0

Figure 43 – Binary inputs window

3.3.3.3 Binary outputs

The **Binary outputs** window (figure 44), device tree menu **Actual values** → **Binary signals** → **Binary outputs**, is designed to display actual state of binary outputs.

No	Name	Value
Hardware discrete outputs		
A-E3 (R1630) Binary outputs module		
1	Emergency alarm	0
2	Warning alarm	0
3	Open CB	0
4	Open CB	0
5	Close CB	0
6	Failure	0
7	Output 1	0
8	Output 2	0
9	Output 3	0
10	Output 4	0
11	Output 5	0
12	Output 6	0
13	Output 7	0
14	Output 8	0
15	Output 9	0
16	Output 10	0

Figure 44 – Binary outputs window

3.3.3.4 CP signals

The **CP signals** window (figure 45), device tree menu **Actual values** → **Binary signals** → **CP signals**, is designed to display actual state of communication processor signals.

Current values / Discrete signals / SSF signals			
No	Name	Value	Alarm type
1	Logic emulation mode	0	
2	IMOS emulation mode	0	
3	Program is started	1	■
4	Test indication module	0	
5	No DSP interrupts	0	
6	Failed apply user settings	0	
7	Configuration error	0	
8	Change settings	0	
9	Oscillograph slice skipped	0	
10	Auto test mode	0	
11	Working with LCD	0	
12	Working with COM1	0	
13	Working with COM2	0	
14	Working with service port	1	■
15	Working with Ethernet	1	■
16	Time was changed from LCD	0	
17	Synchronization over COM1	0	
18	Synchronization over COM2	0	

Figure 45 – **CP signals** window

The description of parameters of CP signals is given in table 9.

Table 9 – Description of parameters of CP signals

Parameter	Description
No.	Sequence number of the CP signal
Name	Name of the CP signal
Value	Actual value of the CP signal
Alarm type	Alarm of the CP signal: – Warning alarm (yellow square); – Emergency alarm (red square); – Information (green square)

3.3.3.5 FP signals

The **FP signals** window (figure 46), device tree menu item **Actual values** → **Binary signals** → **FP signals**, is designed to display actual state of functional processor signals.

Current values / Discrete signals / DSP signals			
No	Name	Value	Alarm type
1	Ready	0	
2	In service	1	■
3	Out of service	0	
4	Indication	0	
5	Reset	0	
6	Power On +12V	1	■
7	Diagnostics	1	■
8	Failure	0	
9	Failure signaling	0	
10	HOST warning error	1	■
11	IRIG-B synchronization error	0	
12	External RAM error	0	
13	PPS synchronization error/absence	0	
14	Configuration error	0	
15	Module error	0	
16	CP is not responding	0	
17	Failed to apply new configuration	0	
18	Reading config error	0	

Figure 46 – **FP signals** window

The description of parameters of FP signals is given in table 10.

Table 10 – Description of parameters of FP signals

Parameter	Description
No.	Sequence number of the FP signal
Name	Name of the FP signal
Value	Value of the FP signal
Alarm type	Alarm of the FP signal: – Warning alarm (yellow square); – Emergency alarm (red square); – Information (green square); – No alarm

3.3.3.6 LEDs

The **LEDs** window (figure 47), device tree menu **Actual values** → **Binary signals** → **LEDs**, is designed to display actual state of device LEDs.

The screenshot shows a window titled "Current values / Discrete signals / LEDs". It contains a table with the following data:

No	Color	Fixation	Name	Value
1	●	+	Start disturb. recorder	0
2	●	+	Start rec. from keyboard	0
3	●	+	Warning signaling	0
4	●		Start	0
5	●	+	Diagnostics	1
6	●	+	Failure	0
7	●	+	Failure signaling	0
8	●		Control relay	0
9	●		Ready	0
10	●		In service	1
11	●		Out of service	0
12	●		Indication	0

Figure 47 – **LEDs** window

The description of parameters of the **LEDs** window is given in table 11.

Table 11 – Description of parameters of the **LEDs** window

Parameter	Description
No.	Sequence number of the LED
Color	LED color
Latching	Latching of the LED
Name	Name of the LED
Value	Actual state of the LED

3.3.3.7 SV diagnostic signals

The **SV diagnostic signals** window (figure 48), device tree menu **Actual values** → **Binary signals** → **SV diagnostic signals**, is designed to display diagnostic signals of sampled values module (protocol of the IEC 61850 standard).

Name	Description	Value
A-E12 D3032		
State of block		
hhError		0
hhNoSyncPTP		0
ASDU1_EKRAMU0001 (Inn)		
Gateway		
replaceStream		0
noSmpSynch		0
noValue		0
oldValue		0
Inn1:		
test		0
good		0
invalid		0
questionable		0

Figure 48 – **SV diagnostic signals** window

3.3.4 Calculated values

The **Calculated values** window (figure 49), device tree menu **Actual values** → **Calculated values**, is designed to display actual calculated values. Calculated values are values added by the user that are calculated during operation of the device. There are two types of calculated values: analog and logic.

№	Name	Value
1	K1_1	0
2	L11	0
3	CB	0
4	1	1

Figure 49 – **Calculated values** window

3.3.5 ADC measurements

The **ADC measurements** window (figure 50), device tree menu **Actual values** → **ADC measurements**, is designed to display actual values of the signals coming to analog to digital converter channels. The latest version devices use only fine channels (even channel numbers of the corresponding ADC).

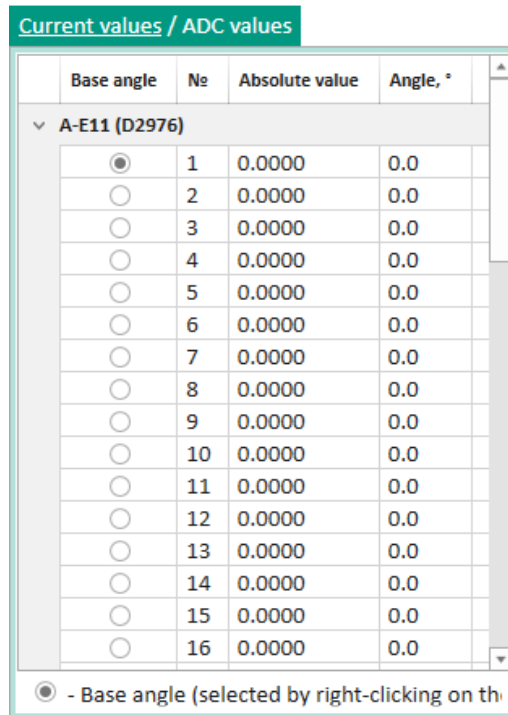

Figure 50 – **ADC measurements** window

The description of parameters of the **ADC measurements** window is given in table 12.

Table 12 – Description of parameters of the **ADC measurements** window

Parameter	Description
Base angle	Base angle
No.	Channel number of the corresponding ADC
Absolute value	Absolute value of the signal component coming to the corresponding ADC channel
Angle, °	Angle of the signal component coming to the corresponding ADC channel, in degrees

3.3.6 HF channel measurements

The **HF channel measurements** window (figure 51), device tree menu **Current values** → **HF channel measurements**, is designed to monitor the states of the HF channel and its own HF transmitter. The menu is available only in devices with teleprotection equipment functionality.

Current values / HF channel measuring		
Name	Value	Unit of measurement
Input security signal level	-52.40	dBm
Input command signal level	-40.40	dBm
Noise level at 4 kHz bandwidth	-43.00	dBm
Stock of security signal level	-32.40	dB
Stock of command signal level	-20.40	dB
Stock of signal/noise	-7.40	dB
Signal/noise level	2.60	dB
Voltage on high frequency output	0.02	V
Current on high frequency output	0.000	A

Figure 51 – HF channel measurements window

The description of parameters of the **HF channel measurements** window is given in table 13.

Table 13 – Description of parameters of the **HF channel measurements** window

Parameter	Description
SS level at HF input	Level of the security signal at the HF input
Command signal level at HF input	Estimated level of the command signal at the HF input (determined by the difference between the set command level and current level of the security signal)
Noise level in 4 kHz band	Level of noise in the operating 4 kHz band
SS level margin	Estimated margin of the security signal level. Margin is defined as the difference between the SS level at the HF input and sensitivity of the HF receiver
Command signal level margin	Estimated margin of the command level. Margin is defined as the difference between the estimated level of a command signal at the HF input and sensitivity of the HF receiver
SNR margin	Estimated margin of the SNR level. The margin is defined as the difference between the estimated SNR level and the SNR threshold for blocking
SNR level	Estimated level of SNR. The SNR level is defined as the difference between the estimated level of command signal and noise level in the 4 kHz band
Voltage at HF output	Voltage at the HF output of the IED, measured by the built-in voltage meter
Current at HF output	Current at the HF output of the IED, measured by the built-in current meter

3.3.7 State of measuring elements

The **Measuring elements status** window (figure 52), device tree menu **Actual values** → **Measuring elements status**, is designed to monitor the state of measuring elements. The **Measuring elements status** window consists of a table of measurements of circuits, logic, phasor diagram and characteristic

curve. The availability and the set of measuring elements depends on device configuration. Work with a phasor diagram is described in 3.3.1.

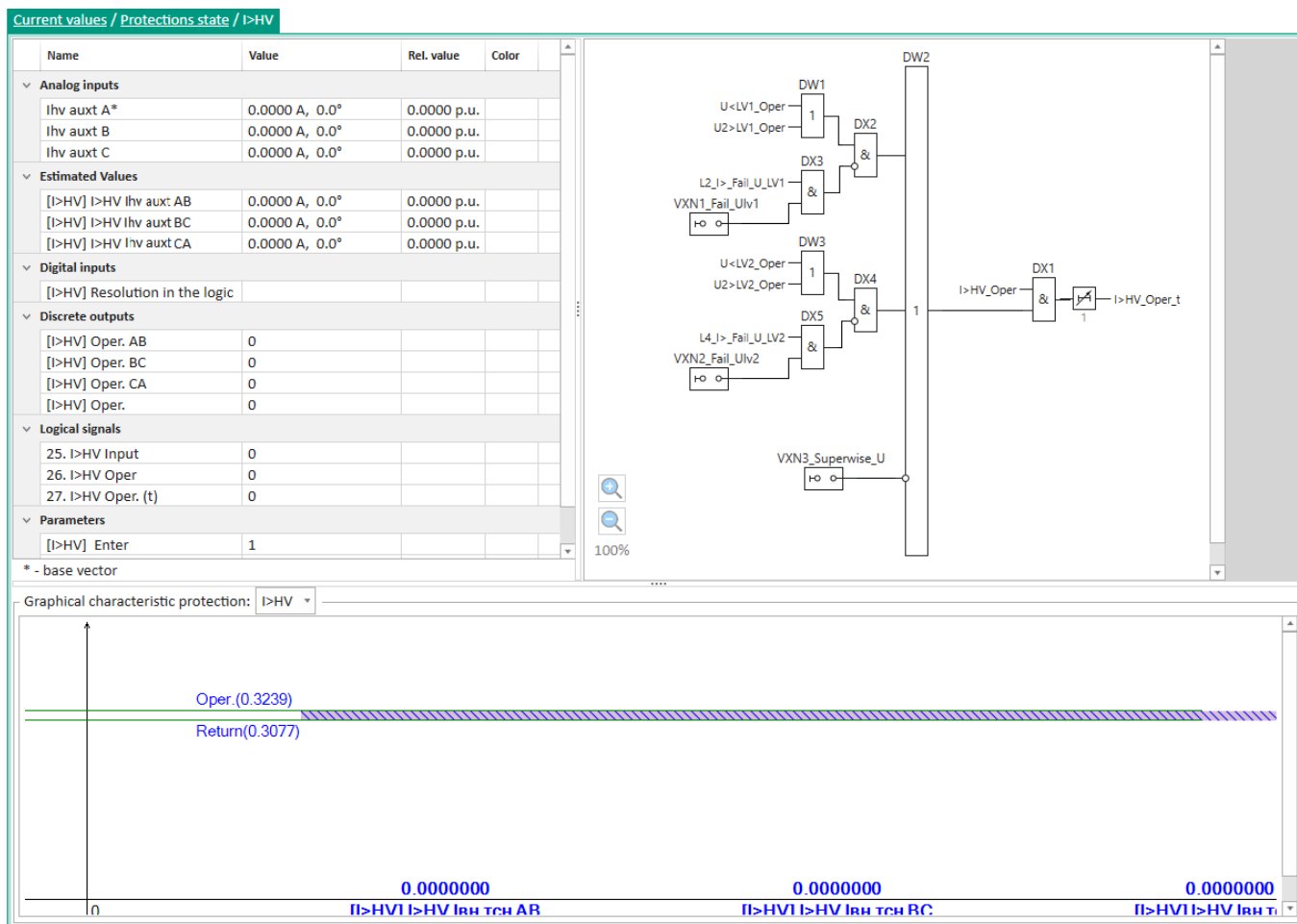

Figure 52 – Measuring elements status window

The description of measuring elements status parameters is given in table 14.

Table 14 – Description of measuring elements status parameters

Parameter	Description
Name	Name of the value
Value	Value of the variable
Rel. value	Relative value of the variable
Color	Phasor color on the phasor diagram

3.3.8 Logic

The **Logic** window (figure 53), device tree menu item **Actual values** → **Logic**, displays the state of all logic components in real time. The red color indicates the state of signals corresponding to the logical “1”.

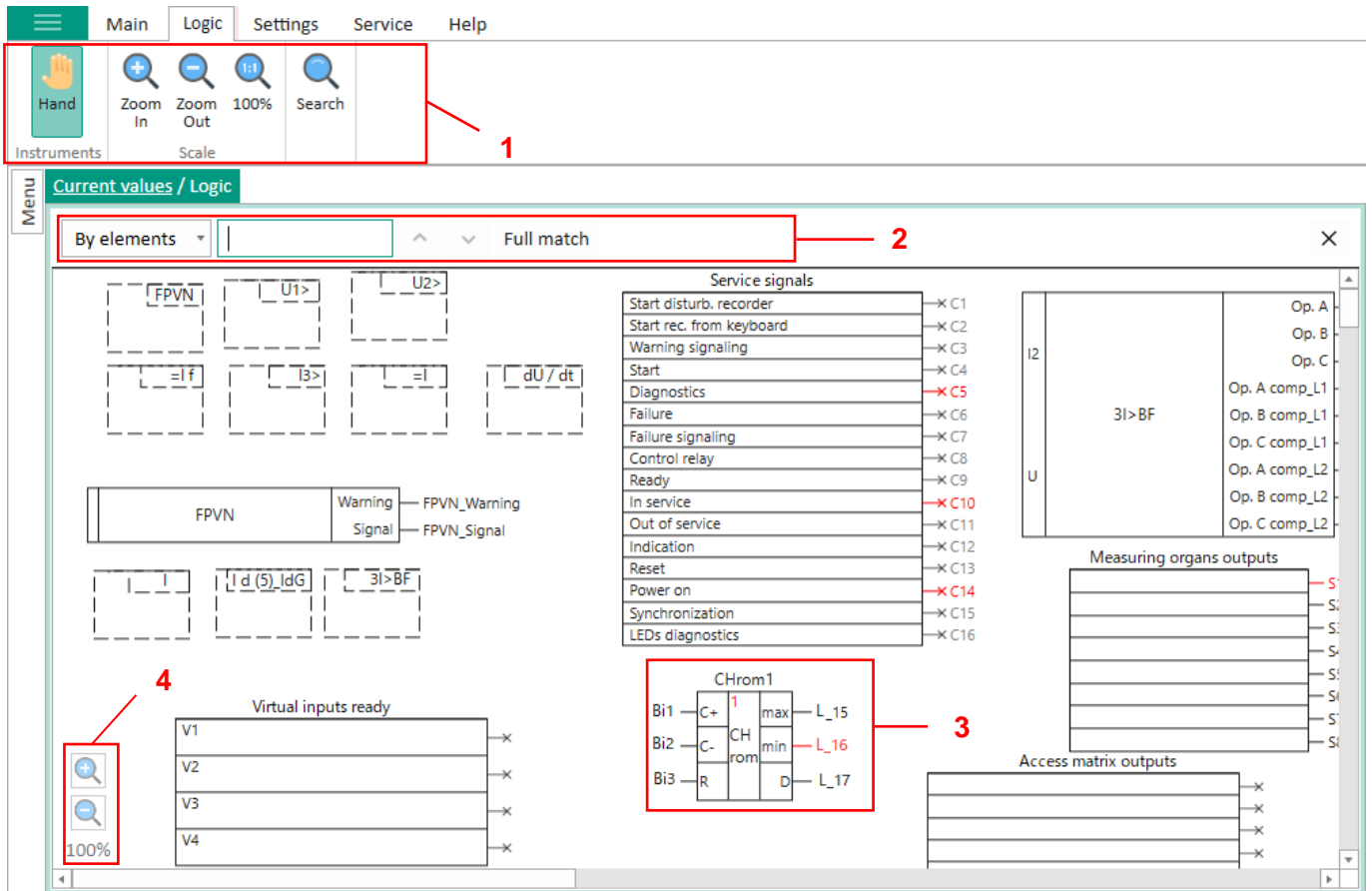



Figure 53 – Logic window

The toolbar allows you to scroll the diagram using the **Hand** tool, zoom and search the logic diagram (figure 53, item 1).

When you click on button  a search field will appear (figure 53, item 2). The search is possible by the name of elements or by the name of addresses. The search result is highlighted in blue (figure 53, item 3).

Also, the scale of the logic diagram can be changed using buttons ,  (figure 53, item 4).

3.4 Tools

3.4.1 Event recorder

The **Event recorder** window (figure 54), device tree menu item **Tools** → **Event recorder**, is designed to display records of the event recorder.

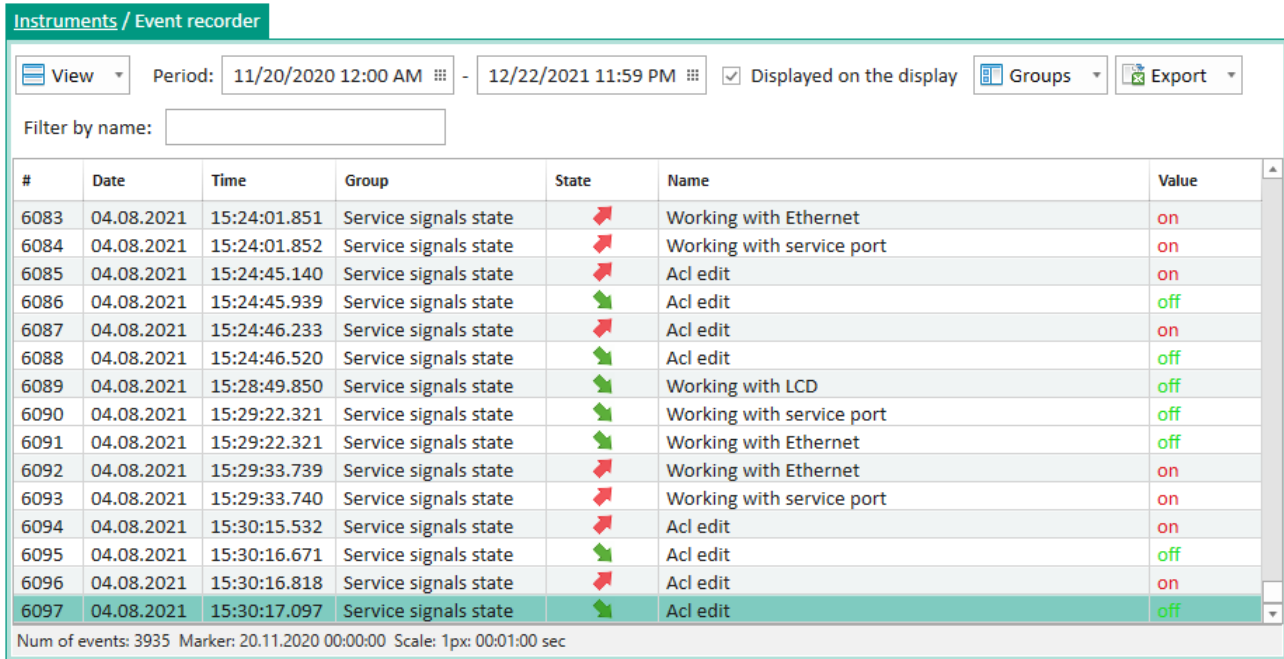

Figure 54 – Event recorder window

Parameters of the **Event recorder** window are shown in table 15.

Table 15 – Parameters of the **Event recorder** window

Name	Description
View	Display options: – Table; – Diagram; – Table and diagram
Period	Filtering events by time (issue events for a specified time interval)
Displayed	Displayed events
Groups	Filtering events by groups. Only those events that belong to the selected group are displayed: – All; – Service FP signals status; – Logic signals; – Binary inputs; – Measuring elements input/output; – Binary outputs; – Service CP signals status; – Calculated values; – Incoming GOOSE
Export	Saving events in Excel or Html format
Filter by name	Filtering events by name
No.	Number of the event
Date	Date of the event
Time	Time of the event
Group	Group of the event

Name	Description
Status	State of the event
Name	Name of the event
Value	Value of the event

3.4.2 Disturbance records

The **Disturbance records** window (figure 55), device tree menu item **Tools** → **Disturbance records**, is designed to work with disturbance records of the device.

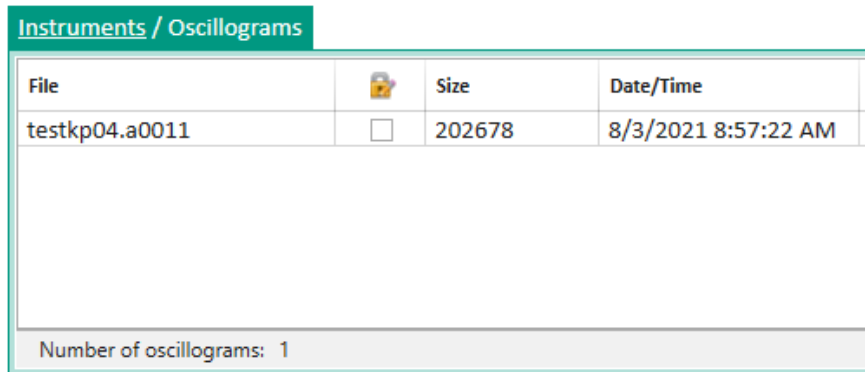



Figure 55 – **Disturbance records** window

Parameters of the **Disturbance records** window are shown in table 16.

Table 16 – Parameters of the **Disturbance records** window

Column	Description
File	Name of the generated disturbance record
	Disturbance record overwrite protection
Size	Size of the disturbance record in bytes
Date/Time	Date and time of disturbance record generation

A disturbance record can be opened by right-clicking on the file of the required disturbance record and selecting the corresponding command (figure 56) or by double-clicking the left mouse button on the file of the required disturbance record. The disturbance record opens in the viewer program, the path to which was specified in line “Disturbance record viewer” (figure 19).

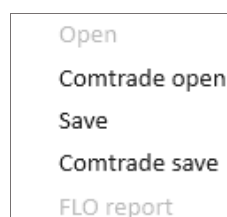

Figure 56 – Context menu of the **Disturbance records** window

Commands of the context menu of the **Disturbance records** window are shown in table 17.

Table 17 – Commands of the context menu

Column	Description
Open	Open the disturbance record
Open in Comtrade	Open the disturbance record in Comtrade format
Save	Save the disturbance record in .a0011 format (internal format that is converted to Comtrade)
Save as Comtrade	Save the disturbance record as Comtrade
FLOC report	FLOC report (available if the device has the FLOC function)

3.4.3 Switching devices

The **Switching devices** window (figure 57) is designed to view the settings of switching devices and monitor the switching and mechanical service life of SD. The **Switching devices** window consists of two parts. The upper part of the window contains brief information about the SD settings, the bottom part of the window contains information about events of the selected switching device and service life of the selected SD setting.

No	Name	Type	Position signaling	POSITION Gateway	A	B	C	ENABLED ON Gateway	A	B	C	ENABLED OFF Gateway	A	B	C	LOCAL CONTROL Gateway	A	B	C
1	Switch control 1	Switch	Common	Disabled (01)															
2	Switch control 2	Switch	Common	Undefined (00)															

No	Date/Time	Phase	State	Gateway	A	B	C

Resource	Gateway	A	B	C
Start resource, %	0	100	100	100
Switch off count	0	0	0	0
Switch co count	0	0	0	0
Residual resource, %	0	100	100	100

Figure 57 – **Switching devices** window

Parameters of the **Switching devices** window are shown in table 18.

Table 18 – Parameters of the **Switching devices** window

Parameter	Description
No.	Number of the switching device
Name	Name of the switching device
Type	Type of the switching device: – Circuit breaker; – Disconnecter
Position signaling	Signaling of the position: – Three-phase; – Single-phase
Switching device Events	Events belonging to the selected switching device
Switching device Service life final	Service life belonging to the switching device at the time of the event selected on the Switching device Events window

Parameter	Description
Position	There are four SD positions (Closed (10), Tripped (01), Undefined (00), Failure (11))
Enable closing	Displays the state of related signals (Imos) that have been set for the switching device. If Imos is specified, then “1” or “0” is displayed
Enable tripping	
Local control	

3.4.4 File Manager

The **File Manager** window (figure 58), device tree menu **Tools** → **File Manager**, is designed to work with the file system. The window consists of two panels. The left panel refers to the file system of the local disk, the right panel refers to the file system of the IED.

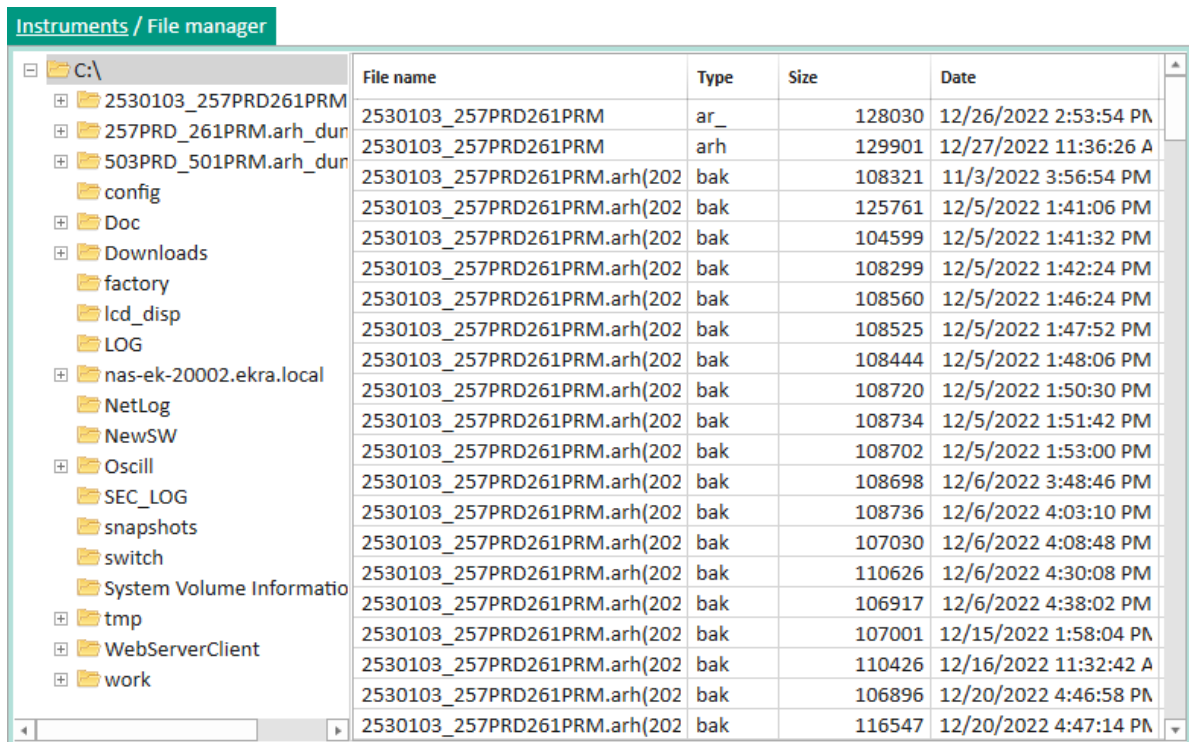

Figure 58 – File Manager window

Parameters of the **File Manager** window are shown in table 19.

Table 19 – Parameters of the **File Manager** window

Column	Description
File name	Name of the file system element (file, directory)
Type	File extension
Size	File size in bytes
Date	Date and time the file was last modified

Note – The **File Manager** window is available when you enter the service function activation key.

3.4.5 Working with IED documents

The **IED documents** window (figure 59), device tree menu item **Tools** → **IED documents** is designed to work with documents that have been loaded into the device by the user. Here you can store circuit diagrams, function diagrams, setting lists and other files related to the device.

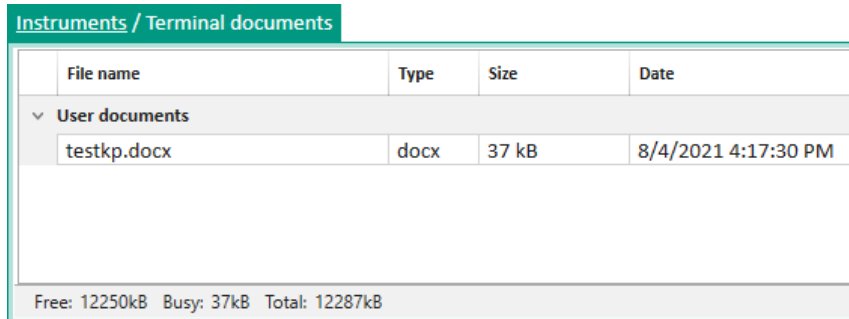

Figure 59 – IED documents window

Parameters of the **IED documents** window are shown in table 20.

Table 20 – Parameters of the **IED documents** window

Column	Description
File name	Name of the file system element (file, directory)
Type	File extension
Size	File size in bytes
Date	Date and time the file was downloaded to the device

The context menu (figure 60) allows you to open, save, load and delete files. The context menu can be opened by right-clicking on the required file. You can download the required file by double-clicking the left mouse button on the file.

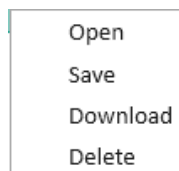

Figure 60 – Context menu of the **IED documents** window

When deleting files, a confirmation request for deletion opens (figure 61). If the answer is yes, marked files will be deleted from the file system.

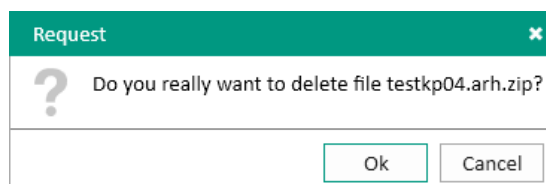

Figure 61 – Confirmation request for file deletion

3.4.6 IED logs

The **IED logs** window (figure 62), device tree menu item **Tools** → **IED logs**, is designed to view event records.

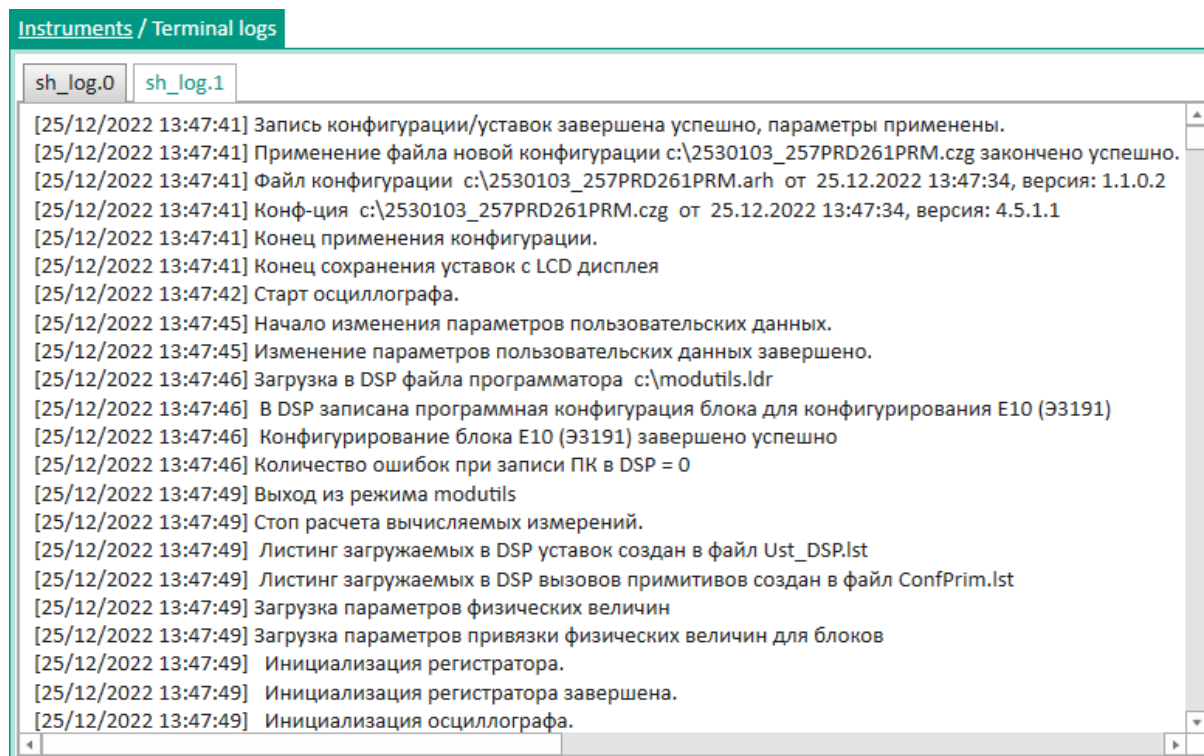

Figure 62 – IED logs window

3.5 Service menu

3.5.1 ADC calibration

To open the **Factors** and **Zero offsets** windows, click “Get started”.

3.5.1.1 Factors

The **Factors** window (figure 63), device tree menu item **Service** → **ADC calibration** → **Factors**, is designed for setting the values of ADC factors.

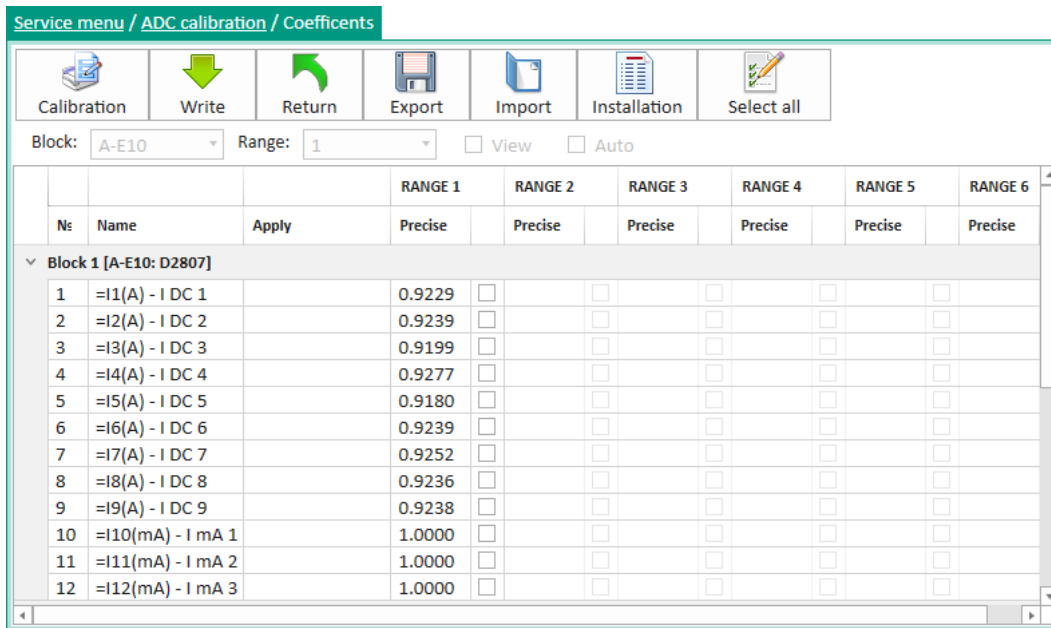









Figure 63 – Factors window

Commands available on the toolbar are shown in table 21.

Table 21 – Toolbar commands

Icon	Name
 Calibration	Enable calibration mode
 Write	Write the values of ADC factors to the module
 Return	Return previous values of ADC factors
 Export	Export values of ADC factors
 Import	Import values of ADC factors
 Installation	Set the value of all ADC factors
 Select all	Check all channels of the current module in the current range

3.5.1.2 Zero offsets

The **Zero offsets** window (figure 64), device tree menu item **Service menu** → **ADC calibration** → **Zero offsets**, is designed to calculate the zero offset.

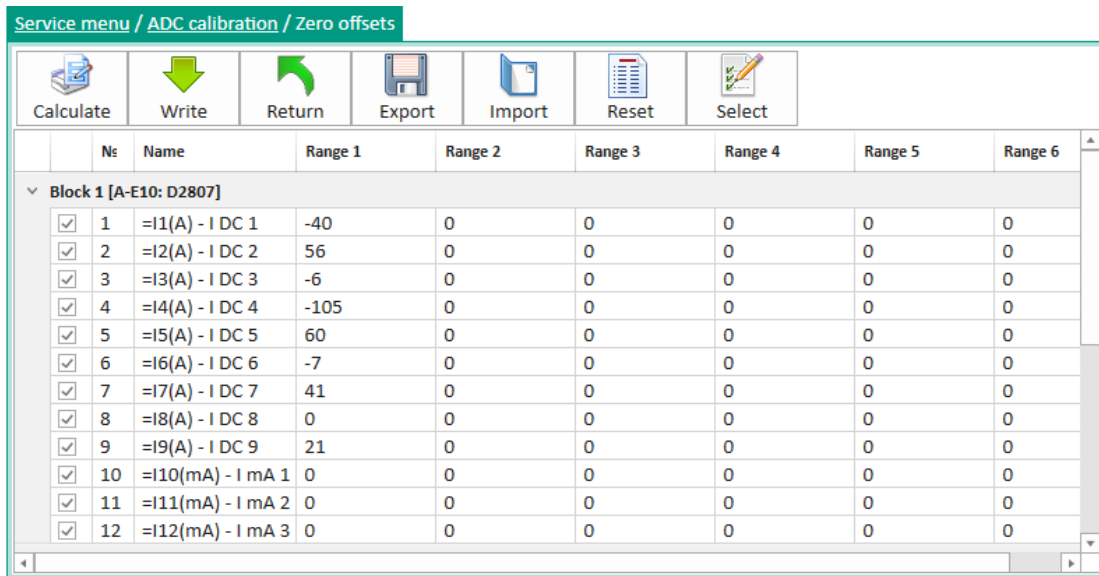









Figure 64 – Zero offset window

Commands available on the toolbar are shown in table 22.

Table 22 – Toolbar commands

Icon	Name
 Calculate	Calculate offsets for selected channels for all bands
 Write	Write values to the module
 Return	Return previous values
 Export	Export values
 Import	Import values
 Reset	Reset the value
 Select all	Check all channels of the current module in the current range

3.5.2 Memory card

The **Memory card** window (figure 65), device tree menu item **Service menu** → **Memory card**, is designed to view the IED memory.

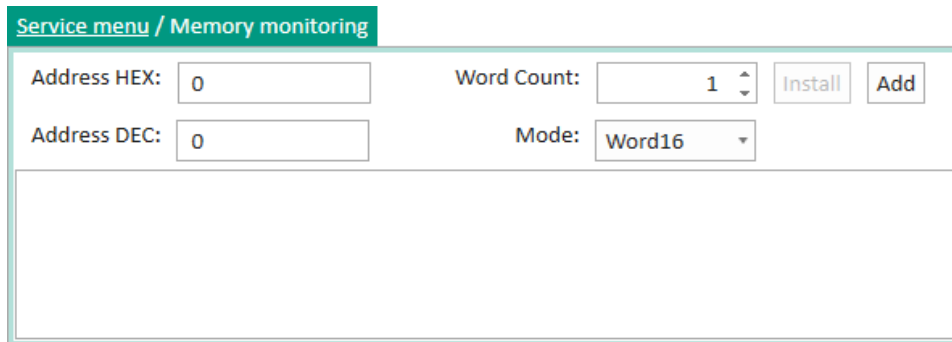

Figure 65 – **Memory card** window

Parameters of the **Memory card** window are shown in table 23.

Table 23 – Parameters of the **Memory card** window

Column	Description
HEX address	Address of the beginning of the viewed memory area in decimal and hexadecimal form
DEC address	
Word count	Quantity of words viewed
Mode	Memory data display modes: – Word16 (in the form of words occupying 16 bits in memory); – Word32 (in the form of words occupying 32 bits in memory); – Float (as a floating-point number); – InvFloat (as a floating-point number in inverse form: the low and high bytes in the word are swapped)
Set	Entering a new area in the memory card
Add	Creating a new memory area

Note – The **Memory card** window is available when you enter the service function activation key.

3.5.3 Communication diagnostics

The **Communication diagnostics** window (figure 66), device tree menu item **Service menu** → **Communication diagnostics**, is designed to view statistics of the operation of the device’s communication protocols. The window contains a drop-down list of protocol selection and a table of counters. When the protocol is selected, the program automatically starts polling and displaying information on the screen with a frequency of 1 s.

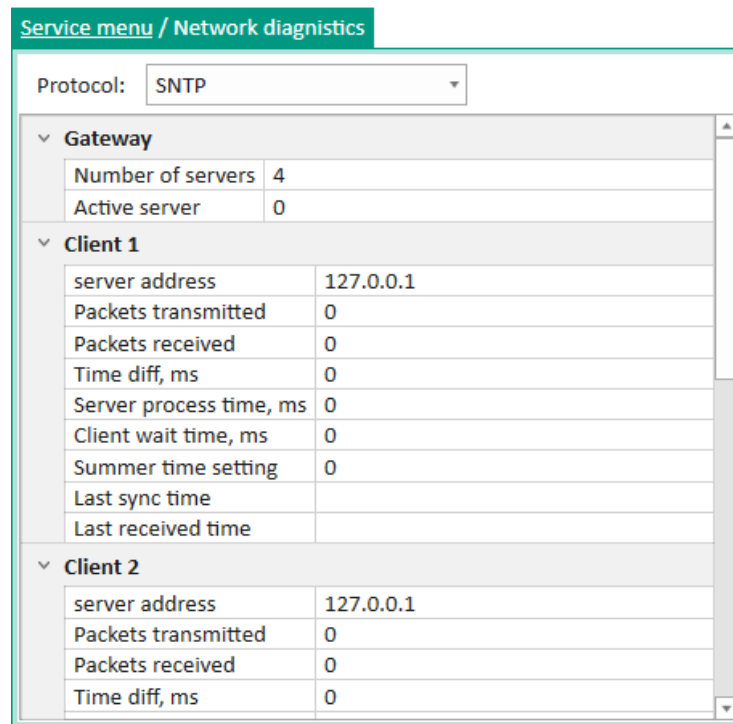

Figure 66 – **Communication diagnostics** window

3.5.4 FP diagnostics

The **FP diagnostics** window (figure 67), device tree menu item **Service menu** → **FP diagnostics**, is designed to view parameters of the function processor.

Service menu / DSP diagnostic								
No	Code section	1	2	3	4	5	6	7
1	Start work cycle	0.686	0.743	0.743	0.743	0.686	0.743	0.743
2	Extracting the data received	75.886	75.771	75.771	75.771	75.714	75.714	75.771
3	Checksum	0.400	0.400	0.400	0.400	0.400	0.400	0.400
4	Formation of the input buffer ou...	6.743	6.743	6.743	6.743	6.743	6.743	6.743
5	Frequency algorithm	26.000	26.000	26.000	26.000	26.000	26.000	26.000
6	Translation frequency format FP(1)	12.971	12.971	12.971	12.971	12.971	12.971	12.971
7	The calculation algorithms of pro...	68.171	68.171	68.171	68.114	68.171	68.171	68.171
8	The calculation algorithms of pro...	106.114	21.771	51.429	21.714	51.429	21.771	51.429
9	Calculating LOG8, LOGIC, SB_DSP...	91.943	62.229	77.657	62.229	77.829	62.286	77.829
10	The calculation of the matrix, the...	36.457	36.571	36.400	36.457	36.343	36.514	36.343
11	Registrator	22.286	22.514	22.514	22.629	22.571	22.686	22.571
12	Handler clicking the "Reset"	2.400	3.371	3.371	3.371	3.371	3.371	3.371
13	The formation of a buffer for out...	0.514	0.514	0.514	0.514	0.514	0.514	0.514
14	Packing data to send	25.543	39.257	39.086	39.257	39.086	39.257	39.086
15	Before writing to the flash (no inf...	0.000	0.000	0.000	0.000	0.000	0.000	0.000
16	After writing to the flash (no info...	0.000	0.000	0.000	0.000	0.000	0.000	0.000
17	Time remaining until the end of t...	522.171	620.514	575.829	620.514	576.571	620.514	575.771
18	The balance of time after comple...	521.486	554.514	554.457	554.457	555.543	554.457	554.457

Figure 67 – **FP diagnostics** window

3.5.5 Hardware configuration of modules

The **Hardware configuration** window (figure 68), device tree menu item **Service menu** → **Hardware configuration**, allows you to view service parameters of device modules.

Service menu / Hardware configuration								
Name	Block type	Barcode	Code	*Group/ **block number	*Modification/ **PS block number	Card version	Bootloader version block, hex	HC block version
A-E1	L2571	12345678910	6	12	1	1	1001	1
A-E2	PU1602	111111111111	1	5	1	1	101	1
A-E	E2822A	0	0	0	0	0	0	0
A-E3	R1630	666666666666	4	3	0	3	101	1
A-E4	R1630	222222222222	4	3	1	2	101	1
A-E5	R1630	333333333333	4	3	1	3	101	1
A-E10	D2807	0	0	0	0	0	0	0
A-E11	D2976	333333333333	5	88	1	1	0	1
A-E12	D3032	0	0	0	0	0	0	0
A-E9	EI2582	555555555555	3	7	0	3	101	1
A-E8	EI2582	59991014763	3	7	0	3	101	1
A-E7	EI2582	59991014762	3	7	0	3	101	1
A-E6	EI2582	59991049688	3	7	0	2	101	1

* - for "0" HC block version
** - for "1" HC block version

Figure 68 – **Hardware configuration** window

The description of columns is given in table 24.

Table 24 – Description of columns of the **Hardware configuration** window

Name	Description
Name	Name of the module
Type	Type of the module
Bar code	Bar code of the module
Code	Code of the module
Module group/number	Number of the module
Module PL version/number	Number of module packing list
Board version	Version of the board
Module loader version, hex	Version of the module loader
Module HC version	Version of hardware configuration of the module

3.5.6 Module diagnostics

In the **Module diagnostics** window (figure 69), device tree menu **Service menu** → **Module diagnostics**, the health of device modules is displayed.

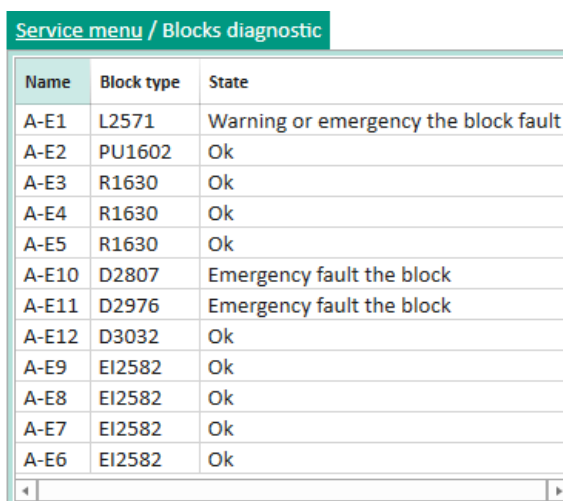

Name	Block type	State
A-E1	L2571	Warning or emergency the block fault
A-E2	PU1602	Ok
A-E3	R1630	Ok
A-E4	R1630	Ok
A-E5	R1630	Ok
A-E10	D2807	Emergency fault the block
A-E11	D2976	Emergency fault the block
A-E12	D3032	Ok
A-E9	EI2582	Ok
A-E8	EI2582	Ok
A-E7	EI2582	Ok
A-E6	EI2582	Ok

Figure 69 – **Module diagnostics** window

The description of columns is given in table 25.

Table 25 – Description of columns of the **Module diagnostics** window

Name	Description
Name	Name of the module
Type	Type of the module
Status	State of the module

3.6 Tests

3.6.1 Logic testing

The **Logic testing** window (figure 70), device tree menu **Tests** → **Logic testing**, allows you testing logic elements – time delays. It also allows you to output any logic signal to the test relay.

In order to switch to the test mode, click the **Enable** button. The “Test mode Enabled” message will appear.



NOTICE

When testing the logic, in order to avoid unwanted shutdown of the primary equipment, it is recommended to exclude the possibility of influence of output relays on external circuits!

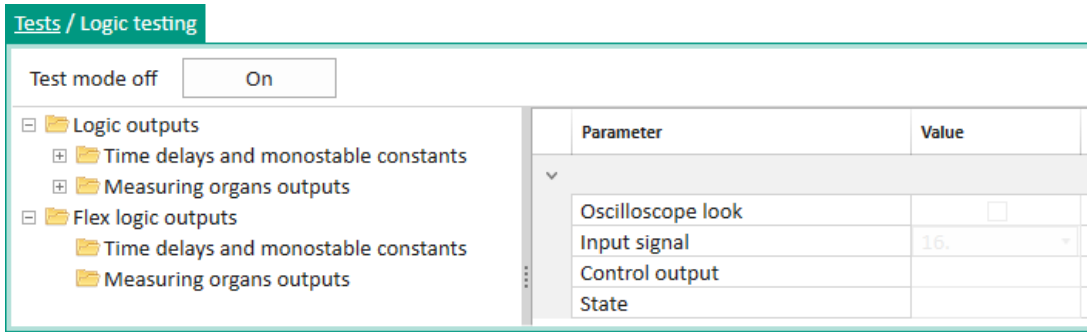

Figure 70 – Logic testing window

Description of parameters of the **Logic testing** window is shown in table 26.

Table 26 – Description of parameters of the **Logic testing** window

Name	Description
Dist. recorder block	Disabling disturbance recording during testing
Input signal	The point of logic is specified from the list, which will be sent to the input of the element with a delay, specified in the list “Time delays and monostable constants”
Control output	The “Measuring elements output” is indicated, which will be issued to the test relay. Or an element with a delay is specified from the list “Time delays and monostable constants”, from the output of which the signal will be sent to the test relay
Status	Terminals of the test relay are indicated

3.6.2 Matrix inputs emulation

The **Matrix inputs emulation** window (figure 71), device tree menu **Tests** → **Matrix inputs emulation**, is designed to emulate operation of the matrix and to check the passage of signals through digital communication channels.

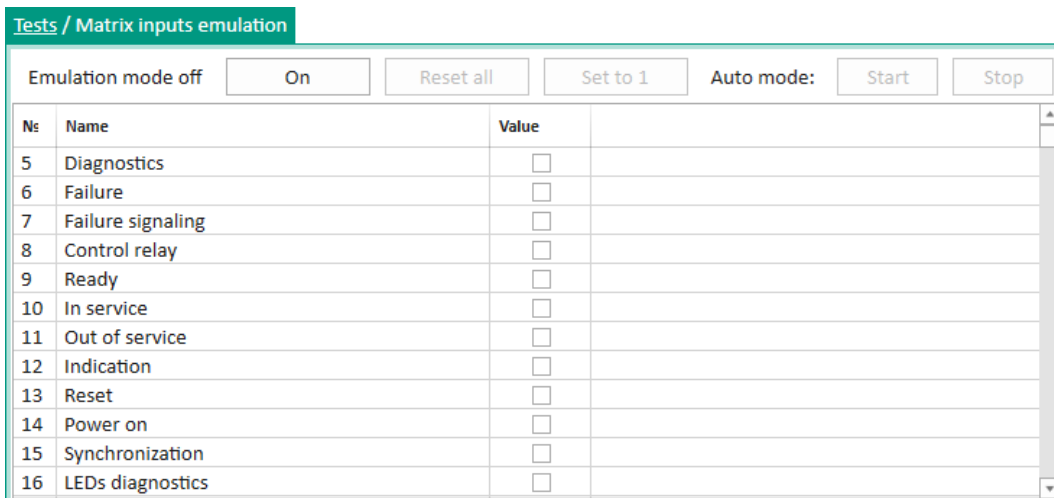

Figure 71 – Matrix inputs emulation window

The description of parameters of the **Matrix inputs emulation** window is given in table 27.

Table 27 – Description of parameters of the **Matrix inputs emulation** window

Parameter	Description
Emulation mode disabled Enable / Emulation mode enabled Disable	Enabling/disabling the emulation mode
Reset all	Unchecking all the boxes in the Value column
Set all to 1	Checking all the boxes in the Value column
Auto mode	Sequential checking of all the boxes of the Value column

The **Matrix inputs emulation** window allows you to set signals at the matrix input. Signals are controlled as follows:

- 1) check the box – set the signal;
- 2) uncheck the box – release the signal.

Emulated signals in the IED take the value in accordance with those specified in the Smart Monitor program.

3.6.3 Logic emulation

The **Logic emulation** window (figure 72), device tree menu item **Tests** → **Logic emulation**, is designed to emulate logic.

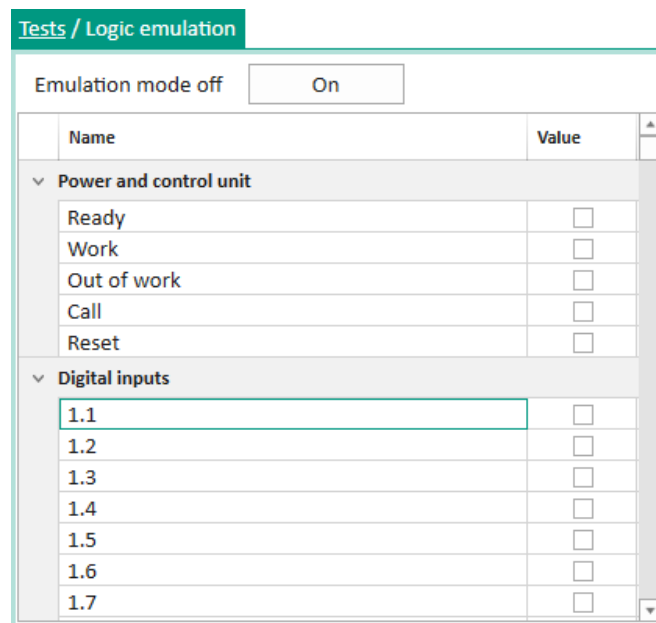

Figure 72 – **Logic emulation** window

In order to switch to the emulation mode, click the **Enable** button. In this case, the “Emulation mode Enabled” message will appear. Signals are controlled as follows:

- 1) check the box – set the signal;
- 2) uncheck the box – release the signal.

The emulated signals in the device take the value in accordance with those specified in the Smart Monitor program.

3.6.4 Data set testing

The **Data set testing** window (figure 73), device tree menu item **Tests** → **Data set testing**, allows you to test data sets.

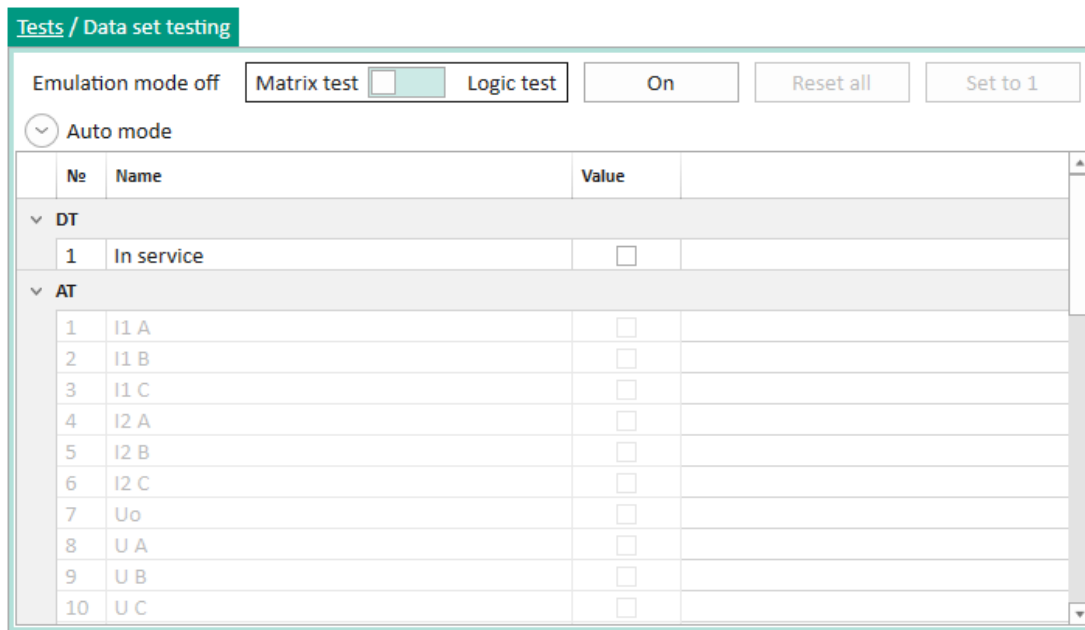

Figure 73 – **Data set testing** window

The description of parameters of the **Data set testing** window is given in table 28.

Table 28 – Description of parameters of the **Data set testing** window

Parameter	Description
Emulation mode disabled Enable / Emulation mode enabled Disable	Enabling/disabling the emulation mode
Matrix test / Logic test	Selection of matrix/logic testing
Reset all	Unchecking all the boxes in the Value column
Set all to 1	Checking all the boxes in the Value column
Auto mode	Sequential checking of all the boxes of the Value column

3.6.5 LED testing

The **LED testing** window (figure 74), device tree menu item **Tests** → **LED testing**, allows you to test the LEDs. To switch to the test mode, click the **Enable** button. The “Test mode Enabled” message will appear. Signals are controlled in three modes (column, cell, all).

Tested signals in the IED take the value in accordance with those specified in the Smart Monitor program.

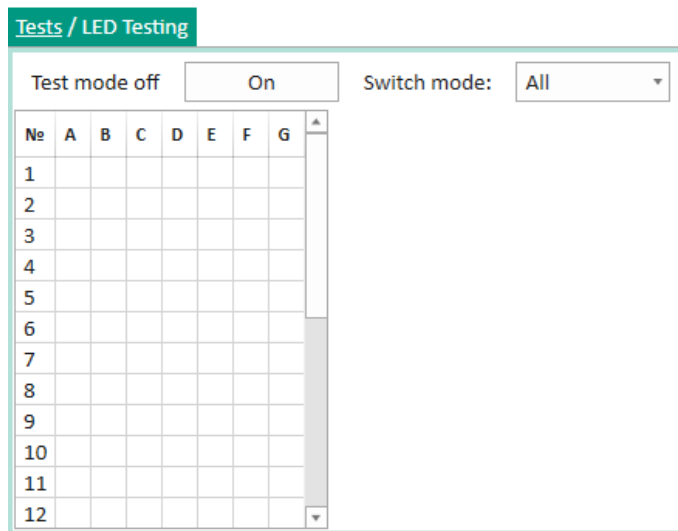

Figure 74 – LED testing window

3.6.6 Relay testing



NOTICE

When issuing test influences on the device relay, it is possible to disconnect the operating equipment!

The **Relay testing** window (figure 75), device tree menu item **Tests** → **Relay testing**, allows you to test output relays by simulating closed and tripped states. In order to switch to the test mode, click the **Enable** button. The “Test mode Enabled” message will appear.

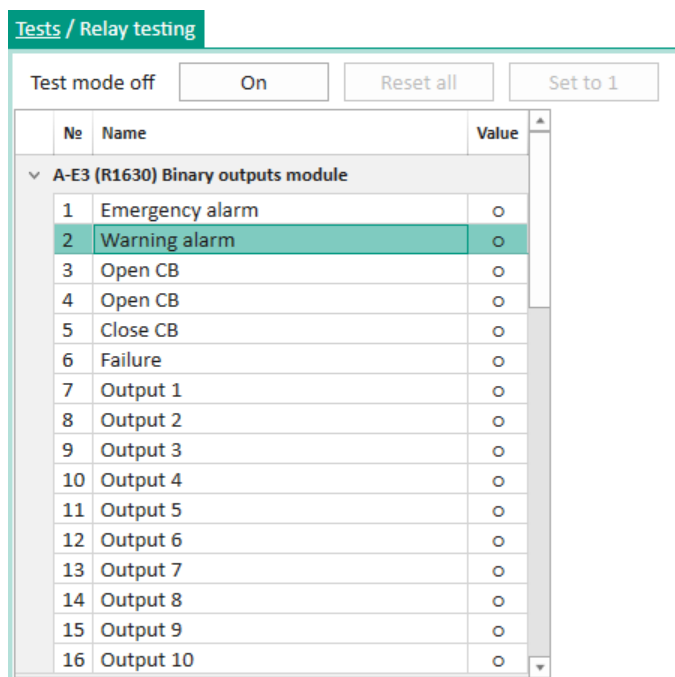

Figure 75 – Relay testing window

The description of parameters of the **Relay testing** window is given in table 29.

Table 29 – Description of parameters of the **Relay testing** window

Parameter	Description
Emulation mode disabled Enable / Emulation mode enabled Disable	Enabling/disabling the test mode
Reset all	Unchecking all the boxes in the Value column
Set all to 1	Sequential checking of all the boxes in the Value column

3.7 Settings

3.7.1 Analog inputs

The **Analog inputs** window (figure 76), device tree menu item **Settings** → **Analog inputs**, is designed to set the base value, transformation ratio and measurement range of analog inputs of the device.

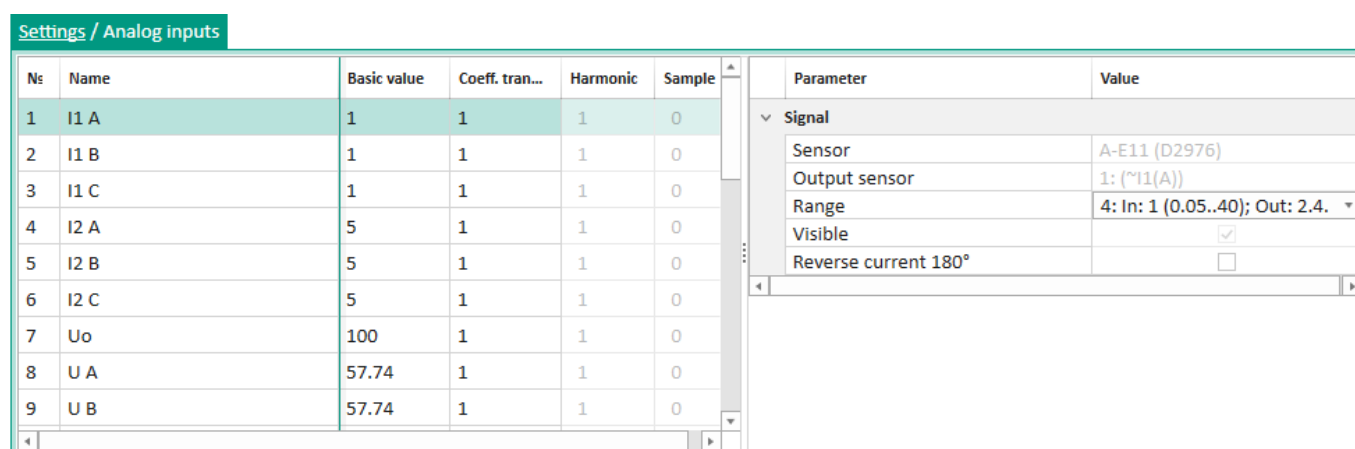

Figure 76 – **Analog inputs** window

Parameters of the **Analog inputs** window are shown in table 30.

Table 30 – Parameters of the **Analog inputs** window

Parameter	Description
No.	Sequence number of the signal
Name	Signal name
Base value	Base value of the corresponding electrical quantity
Trans. ratio	Transformation ratio of the corresponding electrical quantity
Harmonic	Displayed signal harmonic
Sample	Number of the sample on which the signal phasor is created (used to allocate processor time when calculating phasors)
Sensor	Name of the sensor
Sensor output	Name of the sensor output of the selected sensor module
Range	Selecting the measurement range of the sensor
Visible	The checked box enables display of analog input measurement on IEDs screen
Revers current 180°	The checked box reverses current by 180°

3.7.2 Binary inputs

The **Binary inputs** window (figure 77), device tree menu item **Settings** → **Binary inputs**, is designed to specify the settings for binary inputs, and also determines technological time delays for operate and release.

Settings / Digital inputs						
No.	Name	Discrete input entered [▼]	Value on deactivate [▼]	Invert [▼]	Operation DT, ms	Return DT, ms
▼ E8 (E2872) Binary inputs module						
1	Safety valve	<input checked="" type="checkbox"/>	<input type="checkbox"/>	<input type="checkbox"/>	15	6
2	Cut-off valve	<input checked="" type="checkbox"/>	<input type="checkbox"/>	<input type="checkbox"/>	15	6
3	From Bypass CB protections	<input checked="" type="checkbox"/>	<input type="checkbox"/>	<input type="checkbox"/>	15	6
4	Reserve (In.2.4)	<input checked="" type="checkbox"/>	<input type="checkbox"/>	<input type="checkbox"/>	15	6
5	Reserve (In.2.5)	<input checked="" type="checkbox"/>	<input type="checkbox"/>	<input type="checkbox"/>	15	6
6	Reserve (In.2.6)	<input checked="" type="checkbox"/>	<input type="checkbox"/>	<input type="checkbox"/>	15	6
7	Oil temperature	<input checked="" type="checkbox"/>	<input type="checkbox"/>	<input type="checkbox"/>	15	6
8	Oil level	<input checked="" type="checkbox"/>	<input type="checkbox"/>	<input type="checkbox"/>	15	6
9	Multiplication circuits power on	<input checked="" type="checkbox"/>	<input type="checkbox"/>	<input type="checkbox"/>	15	6
10	SA2 "IΔAuxT"	<input checked="" type="checkbox"/>	<input type="checkbox"/>	<input type="checkbox"/>	15	6
11	SA3 "Q1 DISABLE START CBFP Q1"	<input checked="" type="checkbox"/>	<input type="checkbox"/>	<input type="checkbox"/>	15	6
12	SA4 "Q2 DISABLE START CBFP Q2"	<input checked="" type="checkbox"/>	<input type="checkbox"/>	<input type="checkbox"/>	15	6
13	SA7 "Q3 DISABLE"	<input checked="" type="checkbox"/>	<input type="checkbox"/>	<input type="checkbox"/>	15	6
14	SA8 "Q4 DISABLE"	<input checked="" type="checkbox"/>	<input type="checkbox"/>	<input type="checkbox"/>	15	6
15	SG inserted	<input checked="" type="checkbox"/>	<input type="checkbox"/>	<input type="checkbox"/>	15	6
16	Oil level	<input checked="" type="checkbox"/>	<input type="checkbox"/>	<input type="checkbox"/>	15	6

Figure 77 – **Binary inputs** window

Parameters of the **Binary inputs** window are shown in table 31.

Table 31 – Parameters of the **Binary inputs** window

Parameter	Description
No.	Number of the binary input
Name	Name of the binary input
Binary input Enabled	Whether the binary input is enabled or not
Value when disabled	Value of the binary input when it is in its disabled position. Available for editing if there is no checkbox in column Binary input Enabled
Invert	When the box is checked, the signal is allowed to be inverted
Operate DT, ms	Technological time delay for operate in milliseconds
Return DT, ms	Technological time delay for return in milliseconds

3.7.3 Binary outputs

The **Binary outputs** window (figure 78), device tree menu item **Settings** → **Binary outputs**, is designed to specify the settings for binary outputs, including technological time delays for release, as well as settings for virtual binary outputs.

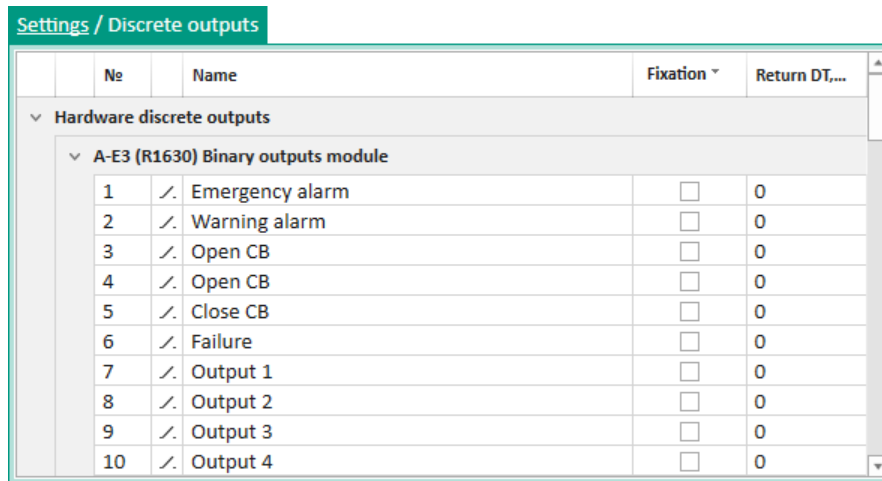

Figure 78 – Binary outputs window

Parameters of the **Binary outputs** window are shown in table 32.

Table 32 – Parameters of the **Binary outputs** window

Parameter	Description
No.	Number of the binary output
Name	Name of the binary output
Latching	Checked box indicates that the binary output is latched (if this box is checked, to return to its initial position, it is necessary to send the Reset alarm command)
Return DT, ms	Return time delay in milliseconds (this field does not apply to virtual binary outputs)

3.7.4 LEDs

The **LEDs** window (figure 79), device tree menu item **Settings** → **LEDs**, is designed for specifying LED settings.

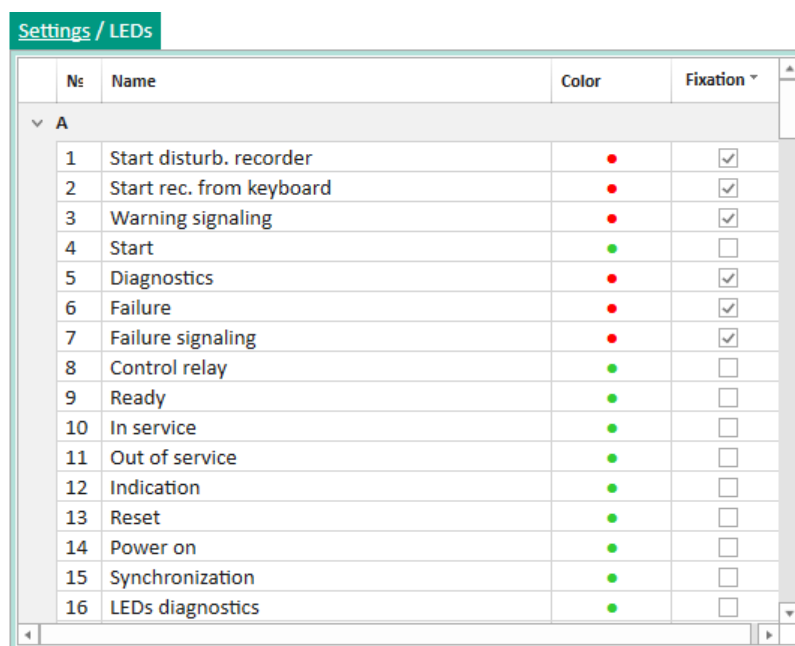

Figure 79 – LEDs window

Parameters of the **LEDs** window are shown in table 33.

Table 33 – Parameters of the **LEDs** window

Parameter	Description
No.	Number of the LED
Name	Name of the LED
Color	Color of the LED (green/red)
Latching	Checked box indicates that the LED is latched (if this box is checked, to return to its initial position, it is necessary to send the Reset alarm command)

3.7.5 Calculated values

The **Calculated values** window (figure 80), device tree menu item **Settings** → **Calculated values**, is designed for viewing and editing the smoothing factor. The smoothing factor is used to smooth out changes (ripples) in the calculated value when calculating analog values. The factor value is set in the range of 0.01 to 1.00.

Parameter	Value	Unit rev.	Description
Update period	500	ms	

№	Name	Coeff.
5	IA	1
6	IB	1
7	IC	1

Figure 80 – **Calculated values** window

3.7.6 Measurements for indication

The **Measurements for indication** window (figure 81), device tree menu item **Settings** → **Measurements for indication**, is designed to set the parameters for displaying information when the **Call** service signal is triggered.

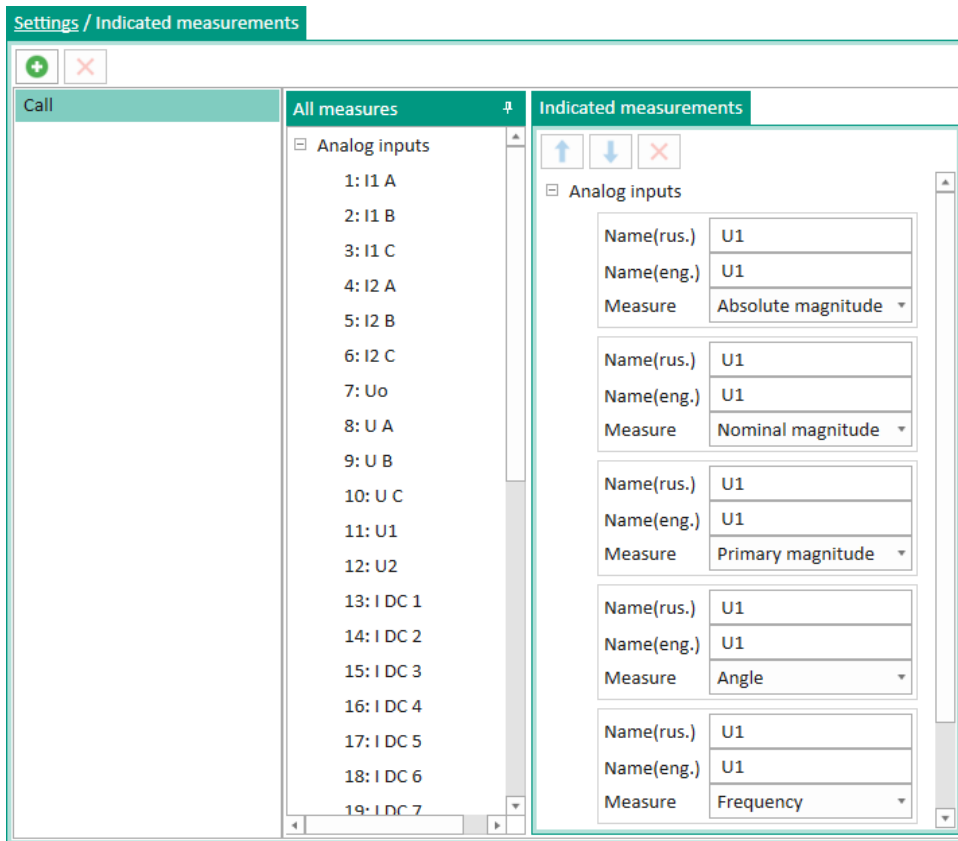

Figure 81 – Measurements for indication window

3.7.7 Switching devices

The **Switching devices** window (figure 82), device tree menu item **Settings** → **Switching devices**, is designed to specify settings for switching devices.

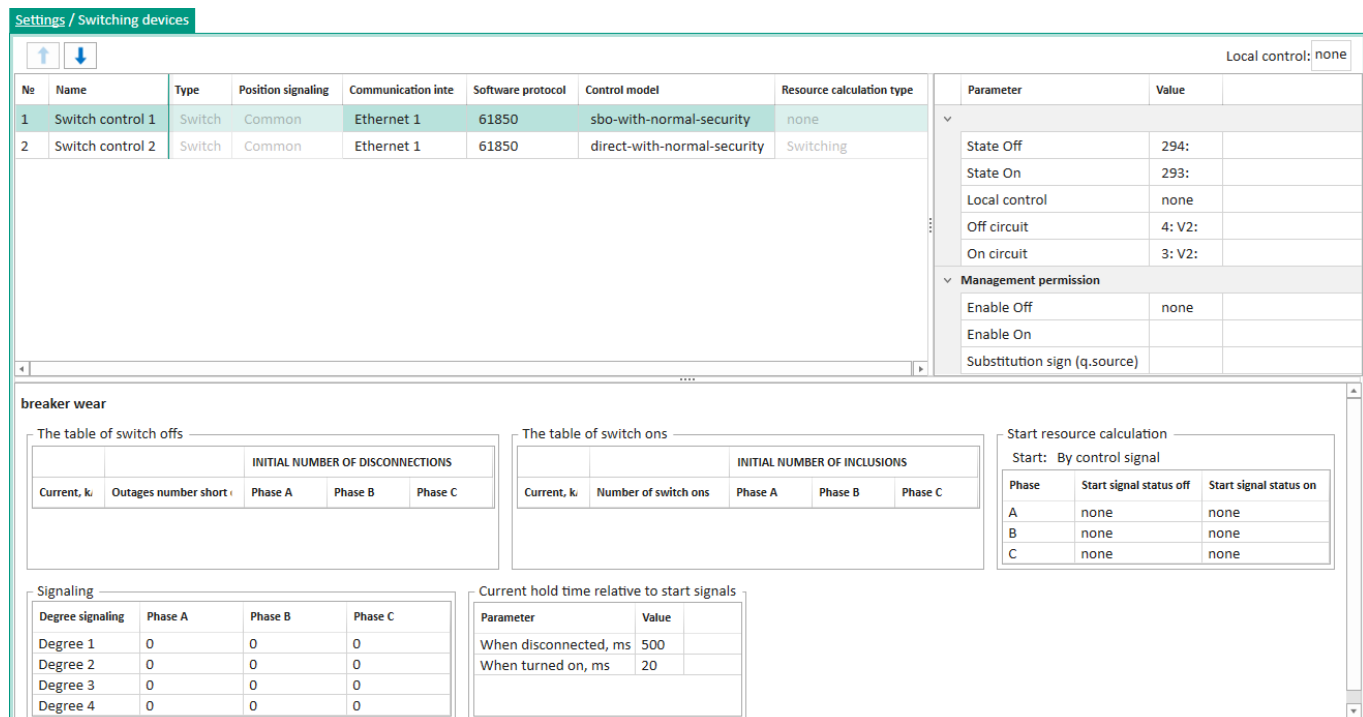

Figure 82 – Switching devices window

Parameters of the **Switching devices** window are shown in table 34.

Table 34 – Parameters of the **Switching devices** window

Parameter	Description
No.	Number of the switching device
Name	Name of the switching device
Type	Circuit breaker or disconnector
Position signaling	Signaling of the position
Communication interface	Communication interface
Program protocol	Used program protocol
Control model	Type of the model for control of the switching device according to IEC 61850
Remaining life calculation type	Type of calculation of the remaining life: – Mechanical; – Switching
Parameter	Tripped/Closed state Parameter name
Value	Setting values of the switching device
Remaining life calculation	Calculation of remaining life is carried out by IED software

3.7.8 Calculated value parameters

The **Calculated value parameters** window (figure 83), device tree menu item **Settings** → **Calculated value parameters**, is designed for viewing and editing parameters of calculated values.

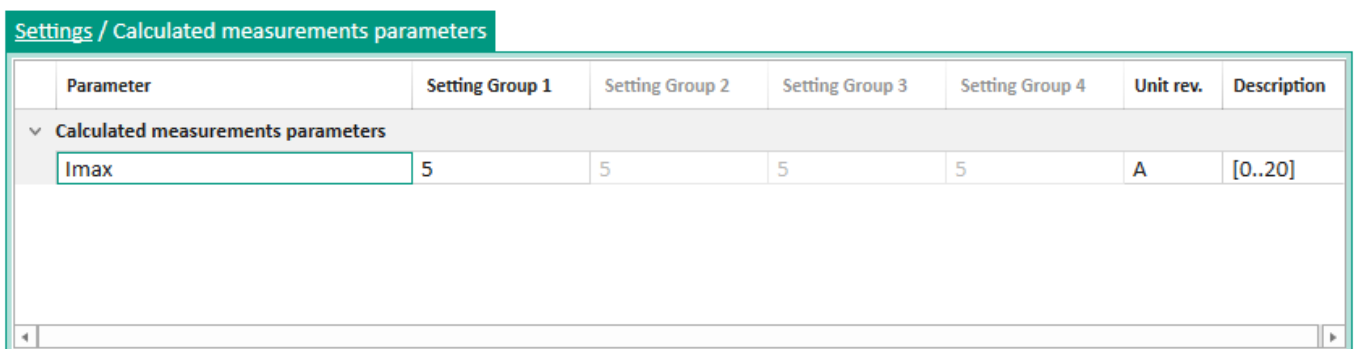

Figure 83 – **Calculated value parameters** window

Parameters of the **Calculated value parameters** window are shown in table 35.

Table 35 – Parameters of the **Calculated value parameters** window

Parameter	Description
Parameter	Parameters of calculated values
Setting group 1 (2, 3, 4...)	Number of the group of settings

Parameter	Description
Unit	Measurement unit
Range	Range of parameters

3.7.9 Measuring elements enable/disable

The **Measuring elements enable/disable** window (figure 84), device tree menu item **Settings** → **Measuring elements enable/disable**, is designed to enable/disable MEs, if it is allowed by the configuration.

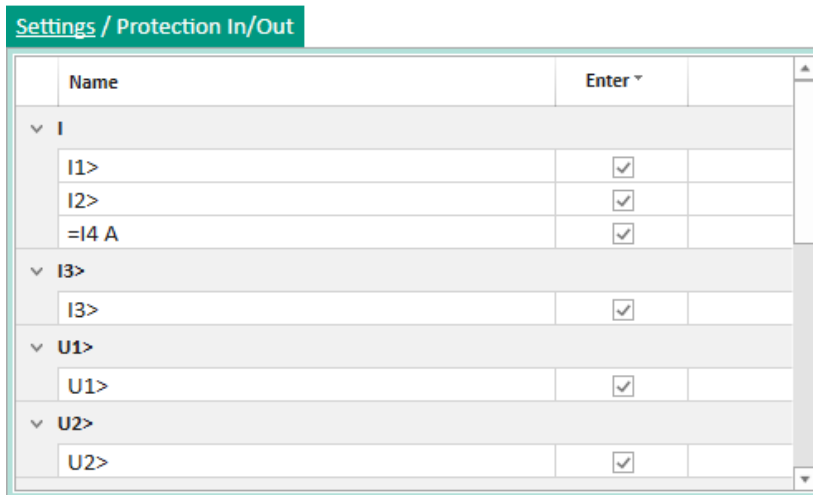

Figure 84 – Measuring elements enable/disable window

3.7.10 Measuring element parameters

3.7.10.1 Parameters

The **Parameters** window (figures 85, 86), device tree menu item **Settings** → **Measuring element parameters** → **Measuring elements**¹⁾ → **Parameters**, is designed to set measuring element parameters.

Settings / Protects settings / I>HV / Parameters						
Settings of protect		Settings of logic elements				
Parameter	Setting group 1	Setting group 2	Setting group 3	Unit rev.	Description	
Parameters I>HV						
Enter	<input checked="" type="checkbox"/>	<input checked="" type="checkbox"/>	<input checked="" type="checkbox"/>			
Oper.	1.000	1.000	1.000	o.e.	[0.047..37.049]	
Kret.	0.95	0.95	0.95		[0.5..1]	

Figure 85 – Measuring element settings tab

¹⁾ Indicated nominally. The availability of protections depends on device configuration.

Parameter	Setting Group 1	Setting Group 2	Setting Group 3	Setting Group 4	Unit rev.	Range
Settings of protect Settings of logic elements						
▼ Pulse generator						
_period	10	10	10	10	s	[3.001..27]
_width	3	3	3	3	s	[0.001..9.999]
▼ Program lining						
	<input type="checkbox"/>	<input type="checkbox"/>	<input type="checkbox"/>	<input type="checkbox"/>		
▼ Pulse shaper						
	1	1	1	1	s	[0.001..9999]
Imp_Switch_Cls	1	1	1	1	s	[0.001..9999]
Imp_Switch_Opn	1	1	1	1	s	[0.001..9999]
Imp_Tech_401	1	1	1	1	s	[0.001..9999]
Imp_Tech_400	1	1	1	1	s	[0.001..9999]
▼ Steps counter						
_min. Level	1	1	1	1		[1..3]
_Initial stage	3	3	3	3		[1..30]
_max. Level	30	30	30	30		[3..64]
_dead levels numbers						

Figure 86 – Logic elements settings tab

The description of columns of the **Parameters** window is given in table 36.

Table 36 – Description of columns of the **Parameters** window

Parameter	Description
Parameter	Parameter of the measuring element
Value	Value of the parameter
Unit	Measurement unit
Range	Range of parameter change

3.7.10.2 Event and disturbance recording

The **Event and disturbance recording** window (figure 87), device tree menu item **Settings** → **Measuring element parameters** → **Measuring element¹⁾** → **Event and disturbance recording**, is designed to set parameters for event and disturbance recording of measuring element signals.

Settings / Protects settings / Group no / Registration and Oscillography										
No	Signal	Name in IEC61850	Reg. ▾	Display ▾	Osc. ▾	Front start ▾	Recession start ▾	Fix. in ACS ▾	Warn. signal ▾	Emerg. signal ▾
1	Start disturb. recorder		<input checked="" type="checkbox"/>	<input checked="" type="checkbox"/>	<input checked="" type="checkbox"/>	<input type="checkbox"/>	<input type="checkbox"/>	<input type="checkbox"/>	<input type="checkbox"/>	<input type="checkbox"/>
2	Start rec. from keyboard		<input checked="" type="checkbox"/>	<input checked="" type="checkbox"/>	<input checked="" type="checkbox"/>	<input checked="" type="checkbox"/>	<input type="checkbox"/>	<input type="checkbox"/>	<input type="checkbox"/>	<input type="checkbox"/>
3	Warning signaling		<input checked="" type="checkbox"/>	<input checked="" type="checkbox"/>	<input checked="" type="checkbox"/>	<input type="checkbox"/>	<input type="checkbox"/>	<input type="checkbox"/>	<input type="checkbox"/>	<input type="checkbox"/>
4	Start		<input type="checkbox"/>	<input type="checkbox"/>	<input type="checkbox"/>	<input type="checkbox"/>	<input type="checkbox"/>	<input type="checkbox"/>	<input type="checkbox"/>	<input type="checkbox"/>
5	Diagnostics		<input checked="" type="checkbox"/>	<input checked="" type="checkbox"/>	<input checked="" type="checkbox"/>	<input type="checkbox"/>	<input type="checkbox"/>	<input type="checkbox"/>	<input type="checkbox"/>	<input type="checkbox"/>
6	Failure		<input checked="" type="checkbox"/>	<input checked="" type="checkbox"/>	<input checked="" type="checkbox"/>	<input type="checkbox"/>	<input type="checkbox"/>	<input type="checkbox"/>	<input type="checkbox"/>	<input type="checkbox"/>
7	Failure signaling		<input checked="" type="checkbox"/>	<input checked="" type="checkbox"/>	<input checked="" type="checkbox"/>	<input type="checkbox"/>	<input type="checkbox"/>	<input type="checkbox"/>	<input type="checkbox"/>	<input type="checkbox"/>
8	Control relay		<input type="checkbox"/>	<input type="checkbox"/>	<input checked="" type="checkbox"/>	<input type="checkbox"/>	<input type="checkbox"/>	<input type="checkbox"/>	<input type="checkbox"/>	<input type="checkbox"/>
9	Ready		<input checked="" type="checkbox"/>	<input checked="" type="checkbox"/>	<input checked="" type="checkbox"/>	<input type="checkbox"/>	<input type="checkbox"/>	<input type="checkbox"/>	<input type="checkbox"/>	<input type="checkbox"/>
10	In service		<input checked="" type="checkbox"/>	<input checked="" type="checkbox"/>	<input checked="" type="checkbox"/>	<input type="checkbox"/>	<input type="checkbox"/>	<input type="checkbox"/>	<input type="checkbox"/>	<input type="checkbox"/>
11	Out of service		<input checked="" type="checkbox"/>	<input checked="" type="checkbox"/>	<input checked="" type="checkbox"/>	<input type="checkbox"/>	<input type="checkbox"/>	<input type="checkbox"/>	<input type="checkbox"/>	<input type="checkbox"/>
12	Indication		<input checked="" type="checkbox"/>	<input checked="" type="checkbox"/>	<input checked="" type="checkbox"/>	<input type="checkbox"/>	<input type="checkbox"/>	<input type="checkbox"/>	<input type="checkbox"/>	<input type="checkbox"/>
13	Reset		<input type="checkbox"/>	<input type="checkbox"/>	<input checked="" type="checkbox"/>	<input type="checkbox"/>	<input type="checkbox"/>	<input type="checkbox"/>	<input type="checkbox"/>	<input type="checkbox"/>
14	Power on		<input checked="" type="checkbox"/>	<input checked="" type="checkbox"/>	<input checked="" type="checkbox"/>	<input type="checkbox"/>	<input type="checkbox"/>	<input type="checkbox"/>	<input type="checkbox"/>	<input type="checkbox"/>
15	Synchronization		<input type="checkbox"/>	<input type="checkbox"/>	<input checked="" type="checkbox"/>	<input type="checkbox"/>	<input type="checkbox"/>	<input type="checkbox"/>	<input type="checkbox"/>	<input type="checkbox"/>
16	LEDs diagnostics		<input type="checkbox"/>	<input type="checkbox"/>	<input type="checkbox"/>	<input type="checkbox"/>	<input type="checkbox"/>	<input type="checkbox"/>	<input type="checkbox"/>	<input type="checkbox"/>

Figure 87 – Event and disturbance recording window

The description of columns of the **Event and disturbance recording** window is given in table 37.

Table 37 – Description of columns of the **Event and disturbance recording** window

Parameter	Description
No.	Number of the signal
Signal	Name of the signal
Name as per IEC 61850	Signal name according to IEC 61850
Event rec.	Recording of the signal. When the box is checked, this signal is recorded by the event recorder
Display	Displaying events in the event recorder menu on the device display
Disturb. rec.	Disturbance recording of the signal
Disturb. rec. edge-trig. start	Start of the disturbance recorder on signal front
Disturb. rec. fall-trig. start	Start of the disturbance recorder on signal fall
Latch. in PCS	Latching in PCS
Warning alarm	Warning alarm
Emergency alarm	Emergency alarm

¹⁾ Indicated nominally. The availability of measuring elements depends on device configuration.

3.7.10.3 Oscillography of calculated parameters

The **Oscillography of calculated parameters** window (figure 88), device tree menu item **Settings** → **Measuring element parameters** → **Measuring element¹⁾** → **Oscillography of calculated parameters**, is designed to set up oscillography of calculated internal measuring element parameters.

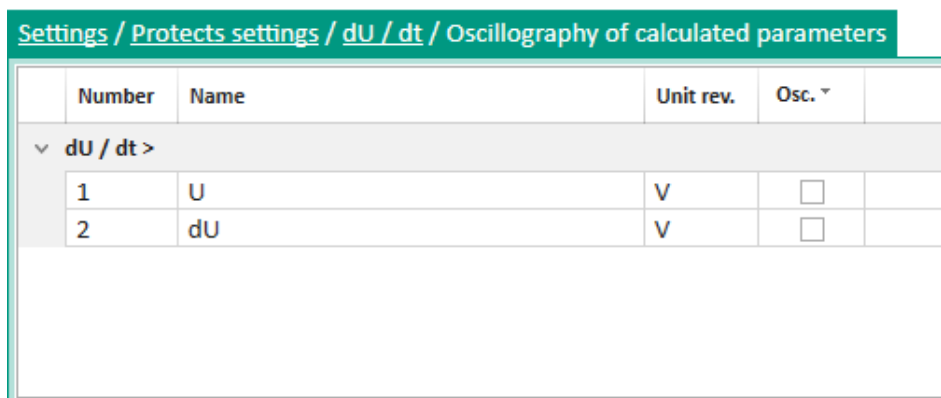

Figure 88 – **Oscillography of calculated parameters** window

The description of columns of the **Oscillography of calculated parameters** window is given in table 38.

Table 38 – Description of columns of the **Oscillography of calculated parameters** window

Parameter	Description
Numder	Numder of the parameter
Name	Name of the parameter
Unit	Unit of the parameter
Disturb. rec.	Selection the parameter for disturbance recorder

¹⁾ Indicated nominally. The availability of measuring elements depends on device configuration.

3.7.10.4 Outputs table

The **Outputs table** window (figure 89), device tree menu item **Settings** → **Measuring element parameters** → **Measuring element**¹⁾ → **Outputs table**, is designed to control the table of device outputs.

Active signals		E4															
Signal		01. Emergency alarm	02. Warning alarm	03. Open CB	04. Open CB	05. Close CB	06. Failure	07. Output 1	08. Output 2	09. Output 3	10. Output 4	11. Output 5	12. Output 6	13. Output 7	14. Output 8	15. Output 9	16. Output 10
1. Start the oscilloscope																	
2. Start the oscilloscope from t...																	
3. Warning																	
4. Warning signaling																	
5. Failure signaling							+										
6. Control relay																	
7. Synchronization																	
8. Reset																	
9. Local control																	
10. Remote control																	
11. Off																	
12. Blocked																	
13. Test/blocked																	

Figure 89 – **Outputs table** window

The cell filled with turquoise **+** means that the table has been modified, but has not yet been written to the device (settings have not been written). This window provides an opportunity for each logic signal (vertical column on the left) to set the effects on device outputs (upper horizontal line) in accordance with the matrix of output circuits of the functional diagram of the measuring element set. If several signals correspond to one output, the influencing signal is determined by the “OR” gate.

¹⁾ Indicated nominally. The availability of measuring elements depends on device configuration.

3.7.10.5 LEDs table

The **LEDs table** window (figure 90), device tree menu item **Settings** → **Measuring element parameters** → **Measuring element**¹⁾ → **LEDs table**, is designed to control the table of device LEDs.

Settings / Protects settings / Group no / LED table

Active signals	A																			
Signal	*	*	*	*	*	*	*	*	*	*	*	*	*	*	*	*	*	*	*	*
	01. Start disturb. record...	02. Start rec. from keyb...	03. Warning signaling	04. Start	05. Diagnostics	06. Failure	07. Failure signaling	08. Control relay	09. Ready	10. In service	11. Out of service	12. Indication	13. Reset	14. Power on	15. Synchronization	16. LEDs diagnostics	17. 1	18. 2	19. 3	20. 4
1. Start disturb. recorder	+																			
2. Start rec. from keyboard		+																		
3. Warning signaling			+																	
4. Start				+																
5. Diagnostics					+															
6. Failure						+														
7. Failure signaling							+													
8. Control relay								+												
9. Ready									+											
10. In service										+										
11. Out of service											+									
12. Indication												+								

Figure 90 – LEDs table window

The cell filled with turquoise **+** means that the table has been modified, but has not yet been written to the device (settings have not been written). This window provides an opportunity for each logic signal (vertical column on the left) to set the effects on display outputs (upper horizontal line) in accordance with the alarm matrix of the functional diagram of the measuring element set. If several signals correspond to one output, the influencing signal is determined by the “OR” gate.

¹⁾ Indicated nominally. The availability of measuring elements depends on device configuration.

3.7.10.6 Logic

The **Logic** window (figure 91), device tree menu item **Settings** → **Measuring element parameters** → **Measuring element**¹⁾ → **Logic**, is designed to view the logic diagram.

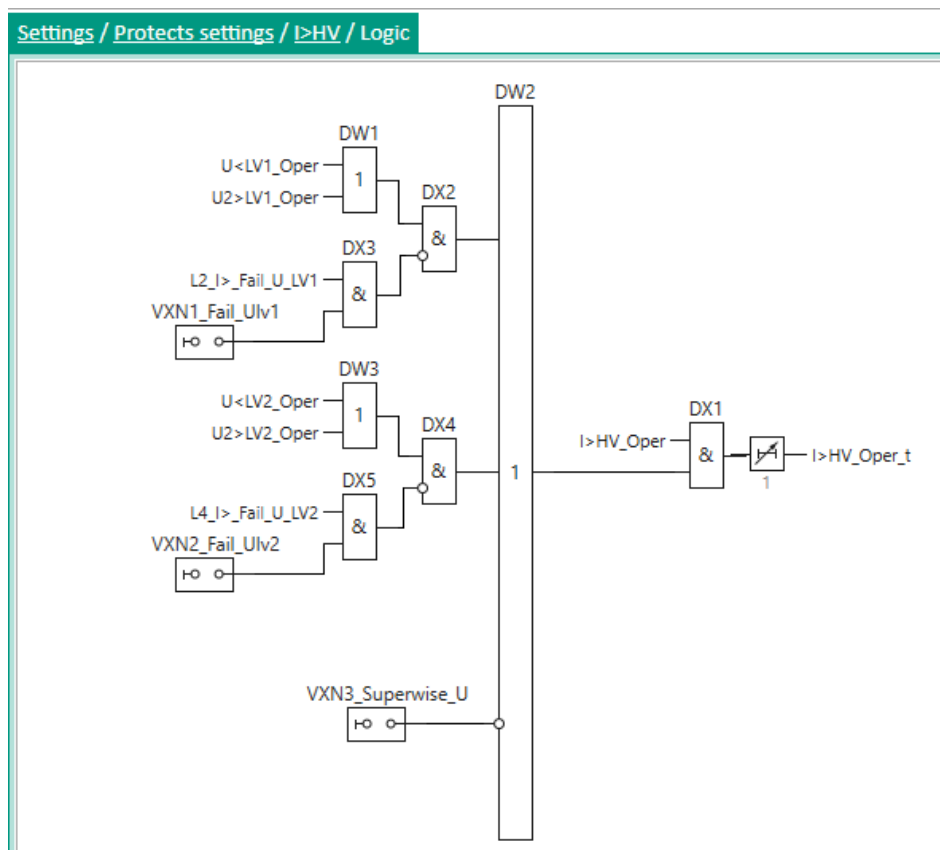

Figure 91 – **Logic** window

3.7.10.7 Tripping matrix

The **Tripping matrix** window (figure 92), device tree menu item **Settings** → **Measuring element parameters** → **Measuring element**¹⁾ → **Tripping matrix**, is designed for editing tripping circuits. The tripping matrix is a compact form of recording matrices of output circuits and indication. Its operation principle is to create tripping circuits – groups of output circuits to which the same signal will be applied. Output circuits may include both relays of output modules and LEDs of indication modules. Such a grouping significantly reduces the matrix record.

¹⁾ Indicated nominally. The availability of measuring elements depends on device configuration.

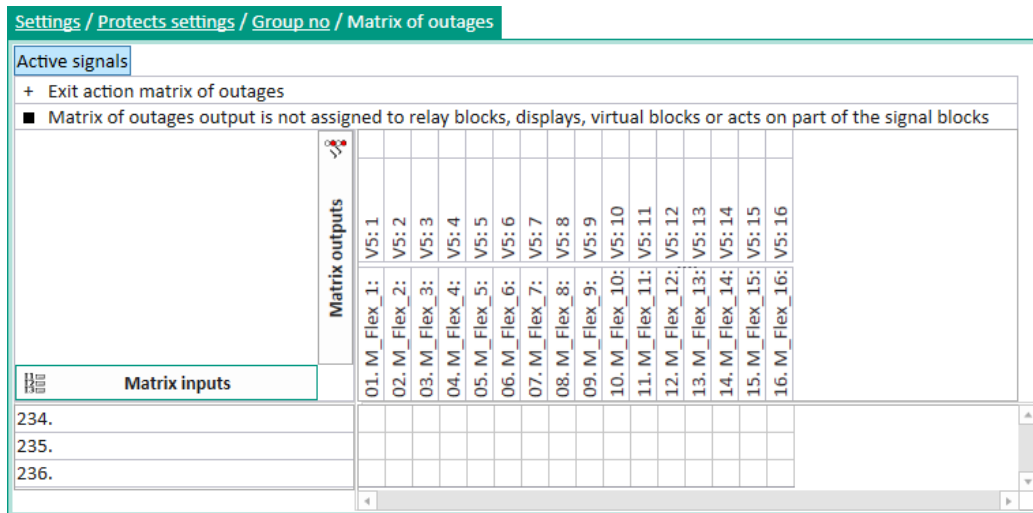

Figure 92 – Tripping matrix window

3.7.10.8 Differences by setting groups

The **Differences by setting groups** window, device tree menu item **Settings** → **Differences by setting groups** is designed to display parameters that differ in different setting groups.

The screenshot shows the 'Settings / Differences in setting groups' window. It displays a table of parameters with columns for 'Parameter', 'Value', 'Unit rev.', and 'Description'. The table is organized into two sections: 'Parameters 3I(Tamb)>1cr_1' and 'Parameters 3I(Tamb)>2cr_1'. The 'Enter' row in both sections has checkmarks in the 'Value' columns. The 'T(7)' row in the first section is highlighted.

Parameter	Value	Value	Value	Value	Unit rev.	Description
Parameters 3I(Tamb)>1cr_1						
Enter	✓	✓	✓	✓		
I(1)	2.000	2.000	2.000	2.000	o.e.	[0.1..40]
T(1)	-40.0	-40.0	-40.0	-40.0	deg.C	[-100..100]
I(2)	1.900	1.900	1.900	1.900	o.e.	[0.1..40]
T(2)	-30.0	-30.0	-30.0	-30.0	deg.C	[-100..100]
I(3)	1.800	1.800	1.800	1.800	o.e.	[0.1..40]
T(3)	-20.0	-20.0	-20.0	-20.0	deg.C	[-100..100]
I(4)	1.700	1.700	1.700	1.700	o.e.	[0.1..40]
T(4)	-10.0	-10.0	-10.0	-10.0	deg.C	[-100..100]
I(5)	1.600	1.600	1.600	1.600	o.e.	[0.1..40]
T(5)	0.0	0.0	0.0	0.0	deg.C	[-100..100]
I(6)	1.500	1.500	1.500	1.500	o.e.	[0.1..40]
T(6)	10.0	10.0	10.0	10.0	deg.C	[-100..100]
I(7)	1.400	1.400	1.400	1.400	o.e.	[0.1..40]
T(7)	20.0	20.0	20.0	20.0	deg.C	[-100..100]
I(8)	1.300	1.300	1.300	1.300	o.e.	[0.1..40]
T(8)	30.0	30.0	30.0	30.0	deg.C	[-100..100]
I(9)	1.200	1.200	1.200	1.200	o.e.	[0.1..40]
T(9)	40.0	40.0	40.0	40.0	deg.C	[-100..100]
I_nonadpt	1.500	1.500	1.500	1.500	o.e.	[0.1..40]
Kret	0.99	0.99	0.99	0.99		[0.5..1]
K_TS	6.250	6.250	6.250	6.250		[-40..40]
I_0_TS	12.00	12.00	12.00	12.00	mA	[-20..20]
T_update	1.00	1.00	1.00	1.00	Minute	[0.02..60]
Parameters 3I(Tamb)>2cr_1						
Enter	✓	✓	✓	✓		
I(1)	2.000	2.000	2.000	2.000	o.e.	[0.1..40]
T(1)	-40.0	-40.0	-40.0	-40.0	deg.C	[-100..100]
I(2)	1.900	1.900	1.900	1.900	o.e.	[0.1..40]
T(2)	-30.0	-30.0	-30.0	-30.0	deg.C	[-100..100]
I(3)	1.800	1.800	1.800	1.800	o.e.	[0.1..40]
T(3)	-20.0	-20.0	-20.0	-20.0	deg.C	[-100..100]
I(4)	1.700	1.700	1.700	1.700	o.e.	[0.1..40]
T(4)	-10.0	-10.0	-10.0	-10.0	deg.C	[-100..100]
I(5)	1.600	1.600	1.600	1.600	o.e.	[0.1..40]
T(5)	0.0	0.0	0.0	0.0	deg.C	[-100..100]
I(6)	1.500	1.500	1.500	1.500	o.e.	[0.1..40]

Figure 93 – Differences by setting groups window

Note – The window is only applicable if multiple setting groups are used in the device.

3.7.11 Event and disturbance recording

3.7.11.1 Disturbance recorder parameters

The **Disturbance recorder parameters** window (figure 94), device tree menu item **Settings** → **Event and disturbance recording** → **Disturbance recorder parameters**, is designed to configure the disturbance recorder parameters.

Settings / Registration and Oscillography / Oscillography parameters			
Parameter	Value	Unit rev.	Description
Pre-accident time	2	s	[0.2..378]
Maximum fault time	4	s	[0.5..380]
Time after the accident	2	s	[0.2..378]
Maximum oscillograms duration	384	s	Time before accident + Max accident time + Time after accident should not exceed this parameter
Number of oscillograms:	1		[1..89]
Maximum count of oscillograms	89		

Figure 94 – **Disturbance recorder parameters** window

The description of disturbance recorder parameters is given in table 39.

Table 39 – Description of disturbance recorder parameters

Parameter	Description
Pre-fault time	Disturbance recording time before fault in seconds
Maximum fault time	Maximum fault recording time in seconds
Post-fault time	Disturbance recording time after fault in seconds
Maximum dist. record duration	Maximum disturbance recording time in seconds (calculated depending on the amount of free memory on the device)
Quantity of disturbance recorder	Quantity of disturbance records stored in the device. If the specified value is exceeded, the disturbance records in the device will be overwritten
Max. quantity of disturbance recorder	Maximum quantity of disturbance records that can be stored in the device (calculated based on the free memory of the device)

3.7.11.2 Analog inputs

The **Analog inputs** window (figure 95), device tree menu item **Settings** → **Event and disturbance recording** → **Analog inputs**, is designed to configure recording of analog signals in the disturbance recorder.

Settings / Registration and Oscillography / Analog inputs			
Nº	Name	Osc. ▾	
1	I1 A	<input checked="" type="checkbox"/>	
2	I1 B	<input checked="" type="checkbox"/>	
3	I1 C	<input checked="" type="checkbox"/>	
4	I2 A	<input checked="" type="checkbox"/>	
5	I2 B	<input checked="" type="checkbox"/>	
6	I2 C	<input checked="" type="checkbox"/>	
7	Uo	<input checked="" type="checkbox"/>	
8	U A	<input checked="" type="checkbox"/>	
9	U B	<input checked="" type="checkbox"/>	
10	U C	<input checked="" type="checkbox"/>	
11	U1	<input checked="" type="checkbox"/>	
12	U2	<input checked="" type="checkbox"/>	
13	I DC 1	<input checked="" type="checkbox"/>	
14	I DC 2	<input checked="" type="checkbox"/>	
15	I DC 3	<input checked="" type="checkbox"/>	

Figure 95 – Analog inputs window

3.7.11.3 Logic signals

The **Logic signals** window (figure 96), device tree menu item **Settings** → **Event and disturbance recording** → **Logic signals**, is designed for setting the parameters for event and disturbance recording of logic signals.

Settings / Registration and Oscillography / Logical signals						
Nº	Signal	Reg. ▾	Display ▾	Osc. ▾	Front start ▾	Recession start ▾
1	Start disturb. recorder	<input checked="" type="checkbox"/>	<input checked="" type="checkbox"/>	<input checked="" type="checkbox"/>	<input type="checkbox"/>	<input type="checkbox"/>
2	Start rec. from keyboard	<input checked="" type="checkbox"/>	<input checked="" type="checkbox"/>	<input checked="" type="checkbox"/>	<input checked="" type="checkbox"/>	<input type="checkbox"/>
3	Warning signaling	<input checked="" type="checkbox"/>	<input checked="" type="checkbox"/>	<input checked="" type="checkbox"/>	<input type="checkbox"/>	<input type="checkbox"/>
4	Start	<input type="checkbox"/>	<input type="checkbox"/>	<input type="checkbox"/>	<input type="checkbox"/>	<input type="checkbox"/>
5	Diagnostics	<input checked="" type="checkbox"/>	<input checked="" type="checkbox"/>	<input checked="" type="checkbox"/>	<input type="checkbox"/>	<input type="checkbox"/>
6	Failure	<input checked="" type="checkbox"/>	<input checked="" type="checkbox"/>	<input checked="" type="checkbox"/>	<input type="checkbox"/>	<input type="checkbox"/>
7	Failure signaling	<input checked="" type="checkbox"/>	<input checked="" type="checkbox"/>	<input checked="" type="checkbox"/>	<input type="checkbox"/>	<input type="checkbox"/>
8	Control relay	<input type="checkbox"/>	<input type="checkbox"/>	<input checked="" type="checkbox"/>	<input type="checkbox"/>	<input type="checkbox"/>
9	Ready	<input checked="" type="checkbox"/>	<input checked="" type="checkbox"/>	<input checked="" type="checkbox"/>	<input type="checkbox"/>	<input type="checkbox"/>
10	In service	<input checked="" type="checkbox"/>	<input checked="" type="checkbox"/>	<input checked="" type="checkbox"/>	<input type="checkbox"/>	<input type="checkbox"/>
11	Out of service	<input checked="" type="checkbox"/>	<input checked="" type="checkbox"/>	<input checked="" type="checkbox"/>	<input type="checkbox"/>	<input type="checkbox"/>
12	Indication	<input checked="" type="checkbox"/>	<input checked="" type="checkbox"/>	<input checked="" type="checkbox"/>	<input type="checkbox"/>	<input type="checkbox"/>
13	Reset	<input type="checkbox"/>	<input type="checkbox"/>	<input checked="" type="checkbox"/>	<input type="checkbox"/>	<input type="checkbox"/>
14	Power on	<input checked="" type="checkbox"/>	<input checked="" type="checkbox"/>	<input checked="" type="checkbox"/>	<input type="checkbox"/>	<input type="checkbox"/>
15	Synchronization	<input type="checkbox"/>	<input type="checkbox"/>	<input checked="" type="checkbox"/>	<input type="checkbox"/>	<input type="checkbox"/>
16	LEDs diagnostics	<input type="checkbox"/>	<input type="checkbox"/>	<input type="checkbox"/>	<input type="checkbox"/>	<input type="checkbox"/>

Figure 96 – Logic signals window

Parameters of the **Logic signals** window are shown in table 40.

Table 40 – Parameters of the **Logic signals** window

Parameter	Description
No.	Number of the signal
Signal	Name of the signal
Event rec.	Event recording of the signal
Display	Displaying events in the menu on the device display
Disturb. rec.	Disturbance recording of the signal
Disturb. rec. edge-trig. start	Start of the disturbance recorder on signal front
Disturb. rec. fall-trig. start	Start of the disturbance recorder on signal fall

3.7.11.4 Binary inputs

The **Binary inputs** window (figure 97), device tree menu item **Settings** → **Event and disturbance recording** → **Binary inputs**, is designed to configure recording of binary input signals in the event recorder and display. In this menu item, you can configure recording for binary hardware signals, digital binary inputs, modules of digital software inputs.

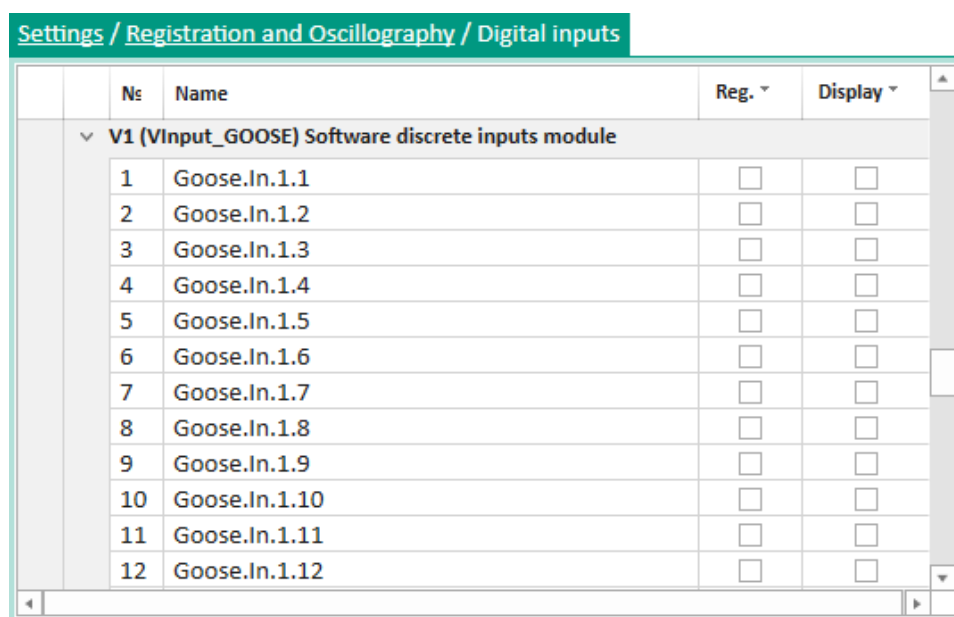

Figure 97 – **Binary inputs** window

Parameters of the **Binary inputs** window are shown in table 41.

Table 41 – Parameters of the **Binary inputs** window

Parameter	Description
No.	Number of the signal
Name	Name of the signal
Event rec.	Event recording of the signal
Display	Displaying events in the event recorder menu on the device display

3.7.11.5 Calculated values

The **Calculated values** window (figure 98), device tree menu item **Settings** → **Event and disturbance recording** → **Calculated values**, is designed for setting signal recording in the disturbance recorder, event recorder and on the display.

No.	Name	Reg. ▾	Display ▾	Osc. ▾
1	K1_1	<input type="checkbox"/>	<input type="checkbox"/>	<input type="checkbox"/>
2	L11	<input type="checkbox"/>	<input type="checkbox"/>	<input type="checkbox"/>
3	CB	<input type="checkbox"/>	<input type="checkbox"/>	<input type="checkbox"/>
4	1	<input type="checkbox"/>	<input type="checkbox"/>	<input type="checkbox"/>
5	I A	<input type="checkbox"/>	<input type="checkbox"/>	<input type="checkbox"/>
6	I B	<input type="checkbox"/>	<input type="checkbox"/>	<input type="checkbox"/>
7	I C	<input type="checkbox"/>	<input type="checkbox"/>	<input type="checkbox"/>

Figure 98 – **Calculated values** window

The description of columns of the **Calculated values** window is given in table 42.

Table 42 – Description of columns of the **Calculated values** window

Parameter	Description
No.	Number of the signal
Name	Name of the signal
Event rec.	Event recording of the signal
Display	Displaying events in the event recorder menu on the device display
Dist.	Disturbance recording of the signal

3.7.11.6 Matrix outputs

The **Matrix outputs** window (figure 99), device tree menu item **Settings** → **Event and disturbance recording** → **Matrix outputs**, is designed for setting signal recording in the event recorder and on the display.

Settings / Registration and Oscillography / Matrix outputs				
No	Name	Reg. ▾	Display ▾	
1	[A-E] A1: Start disturb. recorder	<input type="checkbox"/>	<input type="checkbox"/>	
2	[A-E] A2: Start rec. from keyboard	<input type="checkbox"/>	<input type="checkbox"/>	
3	[A-E] A3: Warning signaling	<input type="checkbox"/>	<input type="checkbox"/>	
4	[A-E] A4: Start	<input type="checkbox"/>	<input type="checkbox"/>	
5	[A-E] A5: Diagnostics	<input type="checkbox"/>	<input type="checkbox"/>	
6	[A-E] A6: Failure	<input type="checkbox"/>	<input type="checkbox"/>	
7	[A-E] A7: Failure signaling	<input type="checkbox"/>	<input type="checkbox"/>	
8	[A-E] A8: Control relay	<input type="checkbox"/>	<input type="checkbox"/>	
9	[A-E] A9: Ready	<input type="checkbox"/>	<input type="checkbox"/>	
10	[A-E] A10: In service	<input type="checkbox"/>	<input type="checkbox"/>	
11	[A-E] A11: Out of service	<input type="checkbox"/>	<input type="checkbox"/>	
12	[A-E] A12: Indication	<input type="checkbox"/>	<input type="checkbox"/>	
13	[A-E] A13: Reset	<input type="checkbox"/>	<input type="checkbox"/>	
14	[A-E] A14: Power on	<input type="checkbox"/>	<input type="checkbox"/>	
15	[A-E] A15: Synchronization	<input type="checkbox"/>	<input type="checkbox"/>	
16	[A-E] A16: LEDs diagnostics	<input type="checkbox"/>	<input type="checkbox"/>	

Figure 99 – Matrix outputs window

3.7.11.7 FP signals

The **FP signals** window (figure 100), device tree menu item **Settings** → **Event and disturbance recording** → **FP signals**, is designed to configure the recording of diagnostic signals of IED's functional processor in the event recorder and on the display.

Settings / Registration and Oscillography / DSP signals				
No	Name	Reg. ▾	Display ▾	
1	Ready	<input checked="" type="checkbox"/>	<input checked="" type="checkbox"/>	
2	In service	<input checked="" type="checkbox"/>	<input checked="" type="checkbox"/>	
3	Out of service	<input checked="" type="checkbox"/>	<input checked="" type="checkbox"/>	
4	Indication	<input checked="" type="checkbox"/>	<input checked="" type="checkbox"/>	
5	Reset	<input checked="" type="checkbox"/>	<input checked="" type="checkbox"/>	
6	Power On +12V	<input checked="" type="checkbox"/>	<input checked="" type="checkbox"/>	
7	Diagnostics	<input checked="" type="checkbox"/>	<input checked="" type="checkbox"/>	
8	Failure	<input checked="" type="checkbox"/>	<input checked="" type="checkbox"/>	
9	Failure signaling	<input checked="" type="checkbox"/>	<input checked="" type="checkbox"/>	
10	HOST warning error	<input checked="" type="checkbox"/>	<input checked="" type="checkbox"/>	
11	IRIG-B synchronization error	<input checked="" type="checkbox"/>	<input checked="" type="checkbox"/>	
12	External RAM error	<input checked="" type="checkbox"/>	<input checked="" type="checkbox"/>	
13	PU warning	<input checked="" type="checkbox"/>	<input type="checkbox"/>	
14	PPS synchronization error/absence	<input checked="" type="checkbox"/>	<input checked="" type="checkbox"/>	
15	Configuration error	<input checked="" type="checkbox"/>	<input checked="" type="checkbox"/>	

Figure 100 – FP signals window

3.7.11.8 CP signals

The **CP signals** window (figure 101), device tree menu item **Settings** → **Event and disturbance recording** → **CP signals**, is designed to configure recording of communication processor signals in the event recorder and on the display.

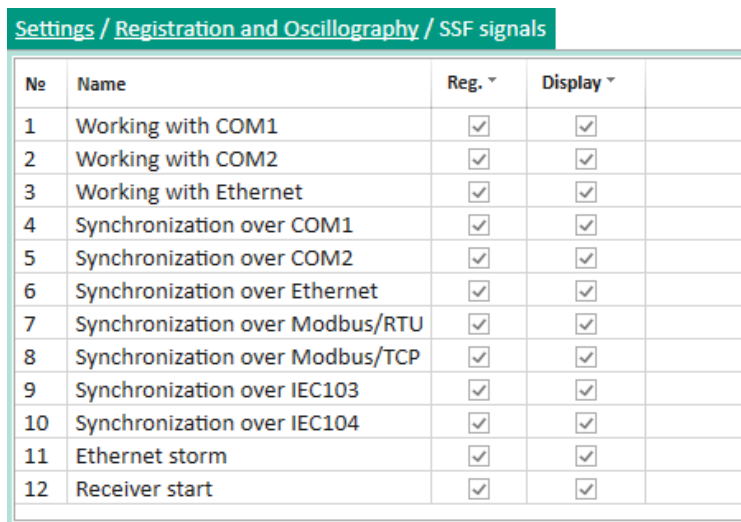

No	Name	Reg. ▾	Display ▾	
1	Working with COM1	<input checked="" type="checkbox"/>	<input checked="" type="checkbox"/>	
2	Working with COM2	<input checked="" type="checkbox"/>	<input checked="" type="checkbox"/>	
3	Working with Ethernet	<input checked="" type="checkbox"/>	<input checked="" type="checkbox"/>	
4	Synchronization over COM1	<input checked="" type="checkbox"/>	<input checked="" type="checkbox"/>	
5	Synchronization over COM2	<input checked="" type="checkbox"/>	<input checked="" type="checkbox"/>	
6	Synchronization over Ethernet	<input checked="" type="checkbox"/>	<input checked="" type="checkbox"/>	
7	Synchronization over Modbus/RTU	<input checked="" type="checkbox"/>	<input checked="" type="checkbox"/>	
8	Synchronization over Modbus/TCP	<input checked="" type="checkbox"/>	<input checked="" type="checkbox"/>	
9	Synchronization over IEC103	<input checked="" type="checkbox"/>	<input checked="" type="checkbox"/>	
10	Synchronization over IEC104	<input checked="" type="checkbox"/>	<input checked="" type="checkbox"/>	
11	Ethernet storm	<input checked="" type="checkbox"/>	<input checked="" type="checkbox"/>	
12	Receiver start	<input checked="" type="checkbox"/>	<input checked="" type="checkbox"/>	

Figure 101 – **CP signals** window

3.7.11.9 Incoming GOOSE

The **Incoming GOOSE** window (figure 102), device tree menu item **Settings** → **Event and disturbance recording** → **Incoming GOOSE**, is designed to set signal recording in the event recorder and on the display.

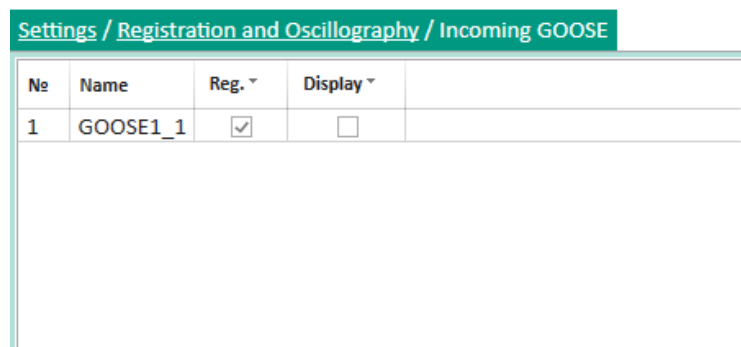

No	Name	Reg. ▾	Display ▾	
1	GOOSE1_1	<input checked="" type="checkbox"/>	<input type="checkbox"/>	

Figure 102 – **Incoming GOOSE** window

3.7.12 System parameters

3.7.12.1 Parameters of IED

The **IED parameters** window (figure 103), device tree menu item **Settings** → **System parameters** → **IED parameters**, is designed for viewing and editing general parameters of the device.

Settings / System parameters / Terminal options				
Parameter	Value	Unit rev.	Description	
▼ Testing				
Test relay	Not set			
▼ Memory				
CF card size	256	MB		
▼ Display				
Language	Russian			
Lcd Backlight timeout	10 min.			
Login Timeout	10 min.			
Default menu item	"Main menu"			
▼ Working frequency				
Frequency of DSP working cycle	1000	Hz		
Logic Frequency	default (on each sample)	Hz		
Oscillography frequency	1000	Hz		
Base frequency	50	Hz		
▼ Delivery parameters				
Object name	Абаканская ТЭЦ			
Terminal functional code	power station RPA			
▼ Discrete input processing time compensation				
Enable time correction	<input type="checkbox"/>			
When going to 1	0	ms		[-50..50]
When going to 0	0	ms		[-50..50]
▼ Display mode analog values in terminal				
Display values	Secondary			

Figure 103 – IED parameters window

Parameters of the **IED parameters** window are shown in table 43.

Table 43 – Parameters of the **IED parameters** window

Parameter	Description
Testing	It sets a test relay for automated testing. In the drop-down list, it is necessary to select a relay module, after selecting the module, specify the desired circuit
Memory	This section displays the size of the memory card installed in the device, in megabytes
Display	This section sets the localization language and the time until the access password is reset, as well as the window that is displayed by default on the device display
Operation frequency	This parameter specifies the frequency of the device's functional processor cycle. Possible parameter values: – 1,000 Hz; – 1,200 Hz; – 2,000 Hz. The value of 1,000 Hz is set in case of using the Sample Value reception report block according to the IEC 61850-9-2LE protocol, as well as in control IEDs. The value 2,000 Hz is set for the functional purpose "Communication device". In all other cases, the value is set to 1,200 Hz. For parameter of Disturbance recording frequency available regular and double frequencies. Rated circuit frequency – 50/60 Hz
Supply parameters	In the Object name field, select the station/substation to which the device will be supplied. The IED functionality code field identifies the device by its functions

Parameter	Description
Binary input process time compensation	<p>The function is designed for recording the time of change in the state of binary inputs at the moment of arrival at device terminals. When the event is saved to the recorder, the time of change in the state of binary inputs is corrected, then the CP, according to the IEC 61850 standard, transmits the state change event of binary inputs using timestamps from the event recorder</p> <p>In the field Enable time correction compensation of processing time of binary inputs is enabled.</p> <p>The On switch to 1 field specifies the time in milliseconds that will be compensated upon switching from logical 0 to 1</p> <p>The On switch to 0 field specifies the time in milliseconds that will be compensated upon switching from logical 1 to 0</p>
Analog value display in IED	<p>Mode of display of analog values:</p> <ul style="list-style-type: none"> – Primary; – Secondary

3.7.12.2 Setting groups

The **Setting groups** window (figure 104), device tree menu item **Settings** → **System parameters** → **Setting groups**, is designed for viewing parameters of setting groups.

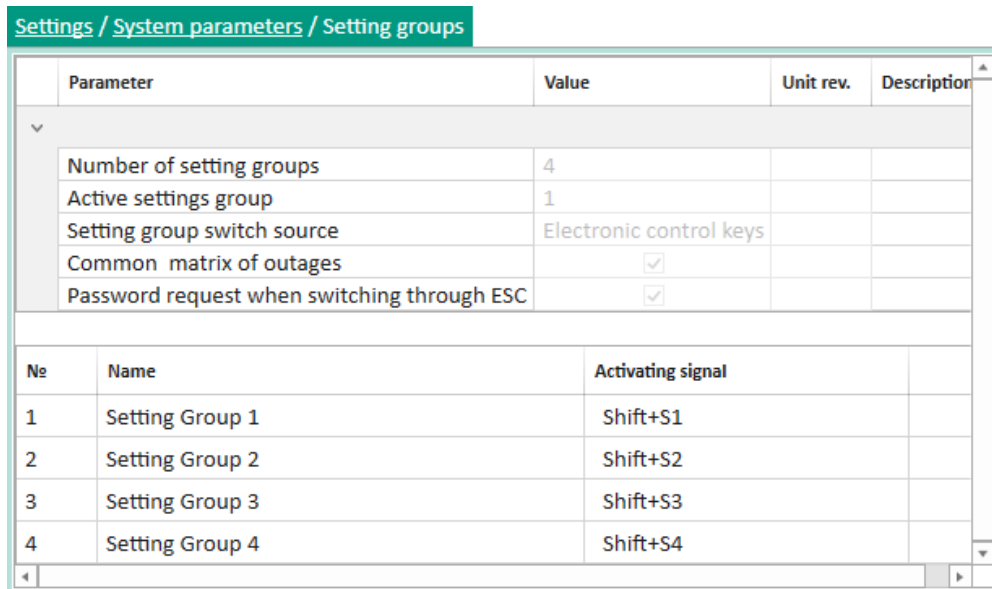

Figure 104 – **Setting groups** window

Parameters of the **Setting groups** window are shown in table 44.

Table 44 – Parameters of the **Setting groups** window

Parameter	Description
Quantity of setting groups	Quantity of setting groups specified in the device
Active setting group by default	Active setting group from the assigned quantity of setting groups
Setting group switching source	Switching sources
Common tripping matrices for all setting groups	Flag at which the tripping matrix is common for all setting groups
Password request when switching setting group via ES	Flag, at which a password is requested when switching a group of settings with electronic switch

Parameter	Description
No.	Number of the setting group
Name	Name of the setting group
Activation signal	Signal of activation of the setting group

3.7.13 Digital communication channels

3.7.13.1 Communication parameters

The **Communication parameters** window (figure 105), device tree menu item **Settings** → **Digital communication channels** → **Communication parameters**, is designed for viewing and editing communication parameters of the device.

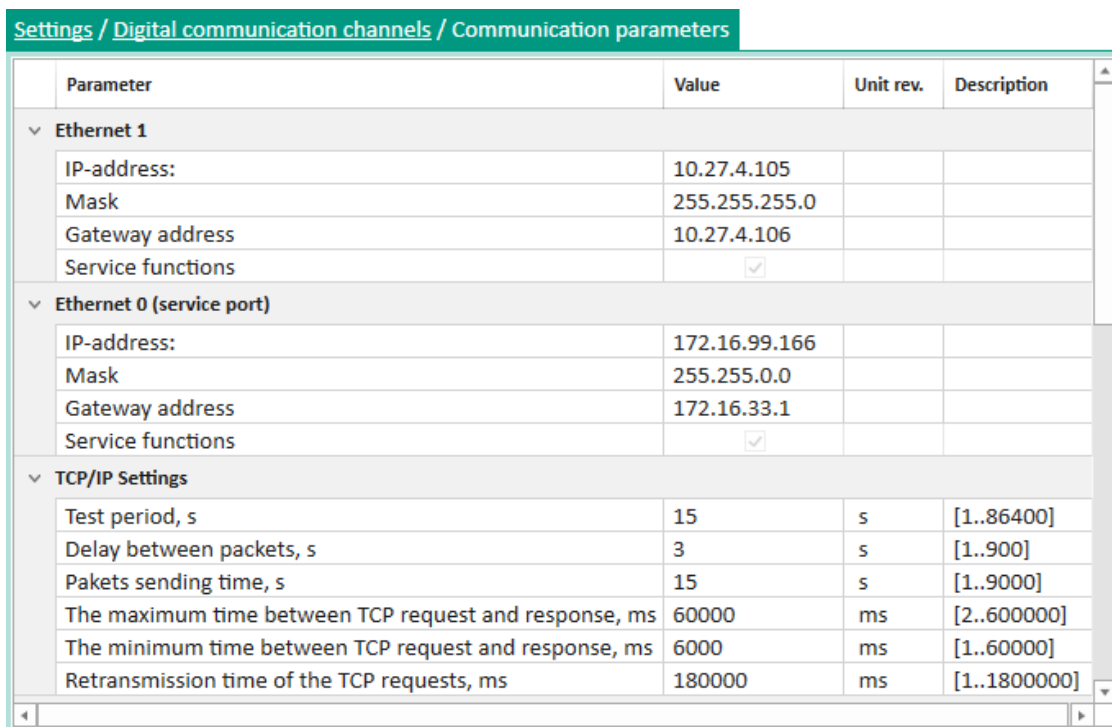

Figure 105 – **Communication parameters** window

Parameters of the **System parameters** window are shown in table 45.

Table 45 – Parameters of the **System parameters** window

Parameter	Description
Parameter	Setting parameter
Value	Parameter value
Unit	Measurement unit
Description	Description of parameter change

3.7.13.2 Redundancy parameters

The **Redundancy parameters** window (figure 106), device tree menu item **Settings** → **Digital communication channels** → **Redundancy parameters**, is designed for viewing and editing parameters of communication channels' redundancy.

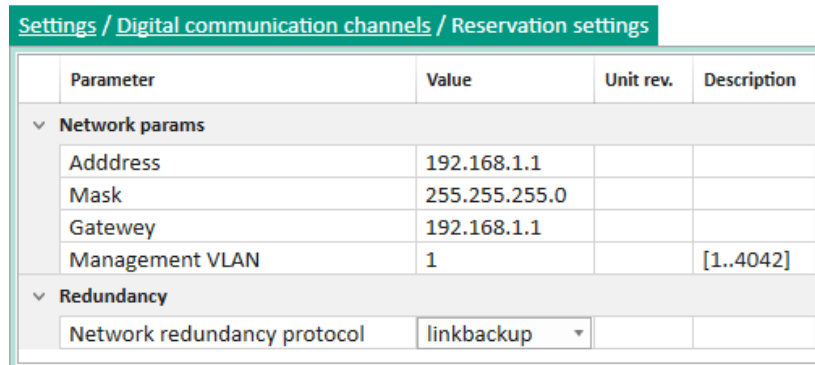

Figure 106 – Redundancy parameters window

Parameters of the **Redundancy parameters** window are shown in table 46.

Table 46 – Parameters of the **Redundancy parameters** window

Parameter	Description
Parameter	Parameter of redundancy protocol
Value	Parameter value
Unit	Measurement unit
Description	Description of parameters

3.7.13.3 Analog input parameters

The **Analog input parameters** window (figure 107), device tree menu item **Settings** → **Digital communication channels** → **Analog input parameters**, is designed for viewing and editing the parameters of analog inputs.

№	Name	Deadband, % of basic value		Deadband		Alarm and confidence thresholds	Range limits					
		Value	Step	Value	Step		Maximum	High top	Top	Bottom	Low bottom	Minimum
1	I1 A	4	0.04	0.04 A	0.0004 A	<input type="checkbox"/>	0.000000	0.000000	0.000000	0.000000	0.000000	0.000000
2	I1 B	4	0.04	0.04 A	0.0004 A	<input type="checkbox"/>	0.000000	0.000000	0.000000	0.000000	0.000000	0.000000
3	I1 C	4	0.04	0.04 A	0.0004 A	<input type="checkbox"/>	0.000000	0.000000	0.000000	0.000000	0.000000	0.000000
4	I2 A	4	0.04	0.2 A	0.002 A	<input type="checkbox"/>	0.000000	0.000000	0.000000	0.000000	0.000000	0.000000
5	I2 B	4	0.04	0.2 A	0.002 A	<input type="checkbox"/>	0.000000	0.000000	0.000000	0.000000	0.000000	0.000000
6	I2 C	4	0.04	0.2 A	0.002 A	<input type="checkbox"/>	0.000000	0.000000	0.000000	0.000000	0.000000	0.000000
7	Uo	0.264	0.0026	0.264 V	0.00264 V	<input type="checkbox"/>	0.000000	0.000000	0.000000	0.000000	0.000000	0.000000
8	U A	0.4572	0.0046	0.264 V	0.00264 V	<input type="checkbox"/>	0.000000	0.000000	0.000000	0.000000	0.000000	0.000000
9	U B	0.4572	0.0046	0.264 V	0.00264 V	<input type="checkbox"/>	0.000000	0.000000	0.000000	0.000000	0.000000	0.000000
10	U C	0.4572	0.0046	0.264 V	0.00264 V	<input type="checkbox"/>	0.000000	0.000000	0.000000	0.000000	0.000000	0.000000
11	U1	0.264	0.0026	0.264 V	0.00264 V	<input type="checkbox"/>	0.000000	0.000000	0.000000	0.000000	0.000000	0.000000
12	U2	0.264	0.0026	0.264 V	0.00264 V	<input type="checkbox"/>	0.000000	0.000000	0.000000	0.000000	0.000000	0.000000
13	I DC 1	4	0.04	0.04 A	0.0004 A	<input type="checkbox"/>	0.000000	0.000000	0.000000	0.000000	0.000000	0.000000
14	I DC 2	4	0.04	0.04 A	0.0004 A	<input type="checkbox"/>	0.000000	0.000000	0.000000	0.000000	0.000000	0.000000
15	I DC 3	4	0.04	0.04 A	0.0004 A	<input type="checkbox"/>	0.000000	0.000000	0.000000	0.000000	0.000000	0.000000

Figure 107 – Analog input parameters window

Parameters of the **Analog input parameters** window are shown in table 47.

Table 47 – Parameters of the **Analog input parameters** window

Parameter	Description
No.	Number of the analog input
Name	Name of the analog input
Deadband, % of base value	Deadband, percentage of nominal and absolute value
Deadband	
Value	Value of the deadband
Step	Step of changing the corresponding value
Alarm and validity thresholds	Threshold values of alarm and validity
Maximum	If the analog value is greater than the setting, the range value becomes high-high and the quality – questionable
Uppermost	If the analog value is greater than the setting, the range value becomes high-high and the quality – good
Upper	If the analog value is greater than the setting, the range value becomes high-high and the quality – good
Lower	If the analog value is greater than the setting, the range value becomes normal and the quality – good
Lowermost	If the analog value is greater than the setting, the range value becomes low and the quality – good
Minimum	If the analog value is less than the setting, the range value becomes low-low and the quality – questionable

3.7.13.4 Calculated value parameters

The **Calculated value parameters** window (figure 108), device tree menu item **Settings** → **Digital communication channels** → **Calculated value parameters**, is designed for viewing and editing parameters of calculated values.

Settings / Digital communication channels / Calculated measurements parameters

Nr	Name	Osc. ▾	Smoothing coeff.	Max. value	Deadband, %	Deadband	Use thresholds ▾	Maximum	High top	Top
5	I A	<input type="checkbox"/>	1	3.402823E+38	0.1	3.402823E+35	<input type="checkbox"/>	0	0	0
6	I B	<input type="checkbox"/>	1	3.402823E+38	0.1	3.402823E+35	<input type="checkbox"/>	0	0	0
7	I C	<input type="checkbox"/>	1	3.402823E+38	0.1	3.402823E+35	<input type="checkbox"/>	0	0	0

Figure 108 – **Calculated value parameters** window



Parameters of the **Calculated value parameters** window are shown in table 48.

Table 48 – Parameters of the **Calculated value parameters** window

Parameter	Description
No.	Number of the calculated value
Name	Name of the calculated value
Dist.	Disturbance recording
Smoothing factor	Used to smooth out changes (ripples) in the calculated value when calculating analog values. The factor value is set in the range of 0.01 to 1.00. Calculation of X value with account for smoothing ratio is calculated by the formula $X = X_{PREV} + k \cdot \Delta X$, where X_{PREV} – previous value; k – smoothing factor; ΔX – increment calculated as a difference between the current and previous values: $\Delta X = X_{CURR} - X_{PREV}$ The value of 0.1 means that the current value will change by 10 % of the difference between the new value and the previous value. The value of 0 is an invalid value, no smoothing. The smoothing factor is set for each calculated value.
Maximum value	Maximum calculated value is specified.
Deadband, %	Specifies an integer from 0 to 100,000. One unit corresponds to 0.001 % of “Max. value”
Deadband	Real value that determines the signal change limit, above which a report on the change in the signal value will be sent. It is equal to the product of parameter “Deadband, % of max. value” of the sensor input to the value of 0.00001
Use thresholds	Use threshold values of alarm and validity
Maximum	If the calculated value is greater than the setting, the range value becomes high-high and the quality – questionable
Uppermost	If the calculated value is greater than the setting, the range value becomes high-high and the quality – good
Upper	If the calculated value is greater than the setting, the range value becomes high and the quality – good
Lower	If the calculated value is greater than the setting, the range value becomes normal and the quality – good
Lowermost	If the calculated value is greater than the setting, the range value becomes low and the quality – good
Minimum	If the calculated value is less than the setting, the range value becomes low-low and the quality – questionable

3.7.13.5 Time synchronization

3.7.13.5.1 Control

The **Control** window (figure 109), device tree menu item **Settings** → **Digital communication channels** → **Time synchronization** → **Control**, allows you to add or remove time synchronization protocols using buttons ,  respectively.

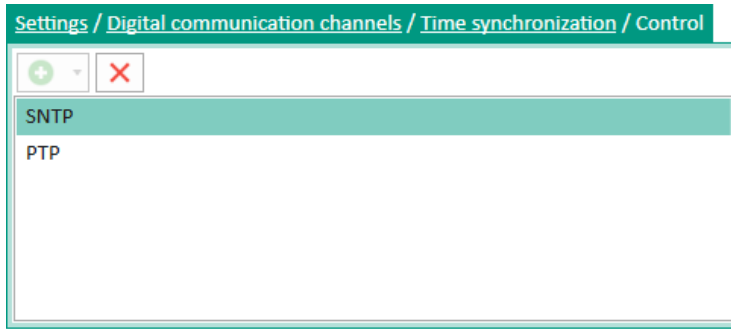

Figure 109 – **Control** window

3.7.13.5.2 Parameters

The **Parameters** window (figure 110), device tree menu item **Settings** → **Digital communication channels** → **Time synchronization** → **Parameters**, is designed to configure software and hardware time synchronization parameters.

Parameter	Value	Unit rev.	Description
Software time synchronization			
Interface	Ethernet 1		
Protocol	ModbusTCP		
Correction	0	hour	[-24..24]
Automatic season time	<input type="checkbox"/>		
Hardware synchronization (PPS)			
Synchronization is enabled	<input type="checkbox"/>		
Clock period	1	s	
Controlled signal change	front		
Minimum pulse width	15	ms	[15..250]
The calibration value	0	ms	[0..250]
Synchronizing pulse period tolerance	25	ms	[1..50]
Synchronization source			
Hardware time synchronization (IRIG-B)			
Synchronization is enabled	<input type="checkbox"/>		
Standard	IRIG-B		
Modification	B007		
Synchronization source	none		

Figure 110 – **Parameters** window

Software synchronization

Parameters of software synchronization are shown in table 49.

Table 49 – Software time synchronization

Parameter	Description
Interface	Selection of interface for software synchronization
Protocol	Protocol for selected interface
Correction	Correction of time synchronization in hours
Adjust for daylight saving time automatically	Checked box indicates automatic switch to summer/winter time

PPS hardware synchronization

Parameters of PPS hardware synchronization are shown in table 50.

Table 50 – PPS hardware synchronization

Parameter	Description
Synchronization enabled	Enable use of PPS hardware synchronization
Synchropulse period	Selection of synchropulse period in seconds
Registered transition	Selection of transition to fall or front (parameter determines when time synchronization occurs)
Minimum pulse duration	Selection of minimum duration of the pulse (for protection from interference and bounce) in milliseconds
Calibration value	Selection of calibration value in milliseconds
Permissible deviation of synchropulse period	Selection of permissible deviation of synchropulse period in milliseconds
Synchronization source	PPS time synchronization source

IRIG-B hardware synchronization

Parameters of IRIG-B hardware synchronization are shown in table 51.

Table 51 – IRIG-B hardware synchronization

Parameter	Description
Synchronization enabled	Enable use of IRIG-B hardware synchronization
Standard	Synchronization standard
Version	Version of the IRIG-B standard. B003 or B007 available for selection
Synchronization source	Selection of IRIG-B time synchronization source

3.7.13.5.3 SNTP

The **SNTP** window (figure 111), device tree menu item **Settings** → **Digital communication channels** → **Time synchronization** → **SNTP**, is designed to configure parameters of the SNTP protocol.

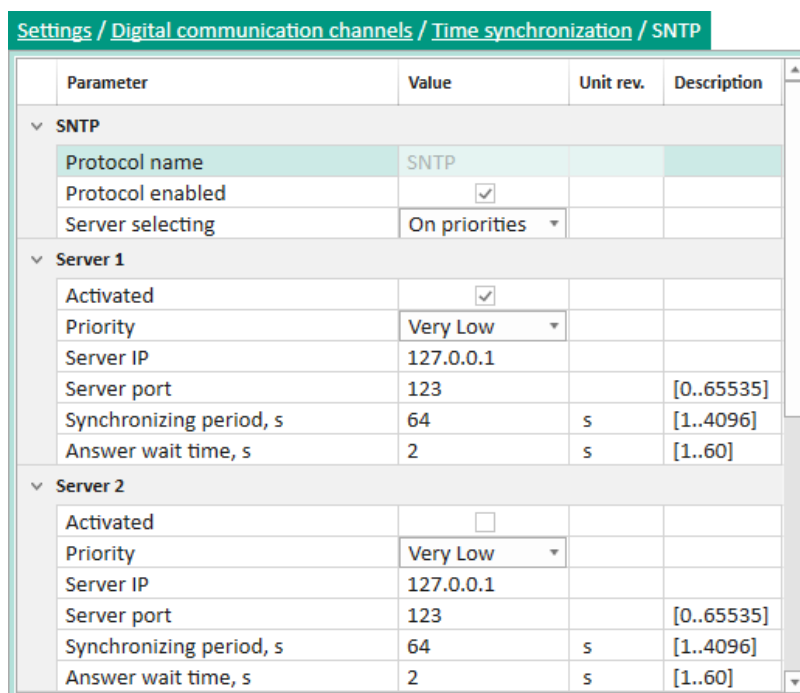

Figure 111 – SNTP window

Parameters of the SNTP protocol are shown in table 52.

Table 52 – Parameters of the SNTP protocol

Parameter	Description
Protocol name	Name of the protocol
Protocol enabled	Enabling data transmission via protocol
Select server	<ul style="list-style-type: none"> – By priority (user additionally sets a priority value for each server. If the set priorities are the same, the first one declared in the device configuration is considered the main one); – Automatically (server is selected by position in the server hierarchy. The most accurate server is at the top level of the hierarchy. When located at the same level of the hierarchy, the first one declared in the device configuration is considered the main one)
Server 1 (2, 3, 4)	
Enabled	Box checked – server 1 (2, 3, 4) is enabled for time synchronization
Priority	It sets the priority level of the server when synchronizing time, if Select server is By priority : <ul style="list-style-type: none"> – Very low; – Low; – High; – Very high
Server IP	Address of the server with which the time is synchronized

Parameter	Description
Server port	Port on the server through which the time is synchronized (123 standard port for SNTP)
Synchronization period, s	Time interval (value must be in the range of 1 to 4,096 s) after which synchronization is repeated
Response wait time, s	Time to wait for a response from the server (value must be in the range of 1 to 60 s)

3.7.13.5.4 PTP

The **PTP** window (figure 112), device tree menu item **Settings** → **Digital communication channels** → **Time synchronization** → **PTP**, is designed to configure parameters of the PTP protocol.

Parameter	Value	Unit rev.	Description
▼ PTP			
Protocol name	PTP		
Protocol enabled	<input checked="" type="checkbox"/>		
Synchronizing period (sec)	60		[2..3600]
Clock type	Boundary		
Management via PTP	<input type="checkbox"/>		
Sync lower bound (1..999999999 nanoseconds)	30		[1..999999999]
Sync upper bound (1..999999999 nanoseconds)	5000		[1..999999999]
(Boundary) domain 0..255	0		[0..255]
(Boundary) priority1 0..255	128		[0..255]
(Boundary) priority2 0..255	128		[0..255]
(Boundary) utc offset -32768..32768 seconds	0		[-32768..32767]
(Boundary) utc offset is valid	<input type="checkbox"/>		
(Transparent) delay mechanism	e2e		
(Transparent) is multi domain	<input type="checkbox"/>		
(Transparent) network protocol	ieee802.3		
(Transparent) primary domain 0..255	0		[0..255]
(Transparent) is sync local clock	<input checked="" type="checkbox"/>		
(Transparent) vlan	2		[2..4095]
(Transparent) vlan-priority 1..7	4		[1..7]

Figure 112 – PTP window

Parameters of the PTP protocol are shown in table 53.

Table 53 – Parameters of the PTP protocol

Parameter	Description
Protocol name	Name of the protocol
Protocol enabled	Checkbox means that the protocol is enabled
Synchronization period, s	Time interval in seconds after which synchronization is repeated
Clock type	It sets the synchronization algorithm (Boundary, Transparent)
Management via PTP	Enabling/disabling the PTP control
Sync lower bound	Minimum time difference between local clock and reference time source in nanoseconds

Parameter	Description
Sync upper bound	Maximum time difference between local clock and reference time source in nanoseconds
(Boundary) domain	Linking a device to a specific PTP domain
(Boundary) priority1	Specifies the priority for port 1
(Boundary) priority2	Specifies the priority for port 2
(Boundary) utc offset	Difference between PTP and UTC timeline in seconds
(Boundary) utc offset is valid	Offset of timeline
(Transparent) delay mechanism	Measurement algorithm of delay in the device transmitted in PTP messages
(Transparent) is multi domain	Operation of PTP synchronization independent from the domain
(Transparent) network protocol	Network protocol through which synchronization messages are transmitted
(Transparent) primary domain	Linking a device to a PTP domain
(Transparent) is sync local clock	Synchronization of local clock
(Transparent) vlan	Operation of PTP in a specified virtual network (VLAN ID), virtual network No
(Transparent) vlan-priority	Priority with which the device transmits messages of PTP synchronization related to this VLAN ID

Note – The availability of the PTP protocol depends on the device type.

3.7.13.6 Communication protocols

3.7.13.6.1 Control

The **Control** window, device tree menu item **Settings** → **Digital communication channels** → **Communication protocols** → **Control**, is designed for adding, deleting and configuring protocols. Adding, deleting is carried out using buttons ,  respectively (figure 113).

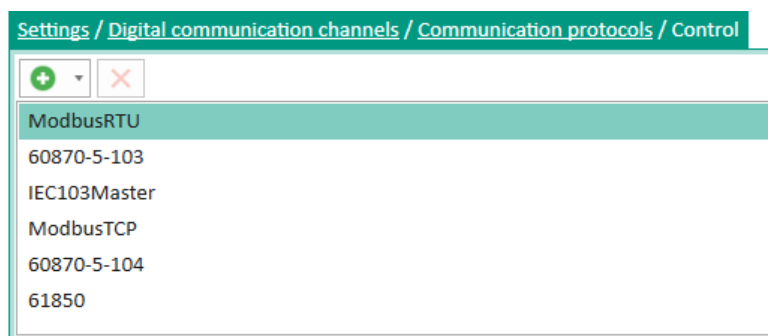

Figure 113 – **Control** window

General parameters of protocols are shown in table 54.

Table 54 – General parameters of protocols

Name	Description
Protocol name	61850 (IEC 61850), ModbusTCP, ModbusRTU*, 60870-5-103* (IEC 60870-5-103), 60870-5-104* (IEC 60870-5-104), IEC103Master (IEC 60870-5-103)
Protocol enabled	Indicator of using the protocol in the configuration

* The common parameter is only the Protocol name.

Note – The list of communication protocols may differ depending on the device type.

3.7.13.6.2 Parameters of the IEC 60870-5-103 protocol (figure 114)

Parameter	Value	Unit rev.	Description
60870-5-103			
Protocol name	60870-5-103		
Transmit type	Periodic & Sporadic		
Delay analogs (sec)	300		[1..900]
Measurand data type	Float(asdu 4)		
Analog data	Analog values		
Binary data	Logic values		
Logic values base address	257		[1..65535]
Binary outputs base address	1281		[1..65535]
Analog values base address	2561		[1..65535]
Calc. values base address	3073		[1..65535]
Skip INF zeros	<input type="checkbox"/>		

Figure 114 – Parameters of the IEC 60870-5-103 protocol

The description of parameters of the IEC 60870-5-103 protocol is given in table 55.

Table 55 – Description of parameters of the IEC 60870-5-103 protocol

Parameter	Description
Protocol name	Name of the protocol
Measurement transmission type	It sets the type of analog signal transmission: <ul style="list-style-type: none"> – Cyclic (after a specified time interval); – Sporadic (when signal changes); – Cyclic & sporadic (after a specified time interval and when the signal changes); – Disabled (information is not transmitted)
Measurement transmission period, s	Time setting delay in seconds when transmitting measurements
Measurement data type	Format of measurements: <ul style="list-style-type: none"> – Floating point (asdu 4); – Fixed point (asdu 9)
Analog data	Analog values / Calculated values / Protection phasors
Binary data	Logic signals / Binary outputs
Base address of logic signals	Decimal value which sets the base address of logic signals
Base address of binary outputs	Decimal value which sets the base address of binary outputs

Parameter	Description
Base address of analog values	Decimal value which sets the base address of analog values
Basic address of calculated values	Decimal value which sets the base address of calculated values
Omit zeros in INF field	When the value of the address parameter for the IEC 60870-5-103 protocol is set, fieldless INF = 0 is generated

3.7.13.6.3 Parameters of the IEC 60870-5-104 protocol (figure 115).

The screenshot shows a configuration window for the IEC 60870-5-104 protocol. The title bar reads 'Settings / Digital communication channels / Communication protocols / 60870-5-104'. The main area is a table with columns: Parameter, Value, Unit rev., and Description. The table is expanded to show the following parameters:

Parameter	Value	Unit rev.	Description
60870-5-104			
Protocol name	60870-5-104		
Protocol enabled	<input type="checkbox"/>		
Clients number	5		[1..10]
Transmit type	Periodic & Sporadic		
Client timeout (sec)	60		[1..120]
Measurand data type	Float		
Measurand cycle (sec)	600		[1..900]
Binary data	Logic values		
Analog data	Analog values		
Logic values base address	257		[1..16777215]
Binary outputs base address	1025		[1..16777215]
Analog values base address	2560		[1..16777215]
Calc. values base address	3072		[1..16777215]
Protect vectors base address	3328		[1..16777215]
Transfer mode	Balanced		
ASDU address size	2		
Cause of transmission size	2		
Info object address size	3		
k Max APDUs without ACK	12		[1..32767]
w Latest ACK after recv. w APDUs	8		[1..32767]
Address ASDU	1		[1..247]

Figure 115 – Parameters of the IEC 60870-5-104 protocol

The description of additional parameters of the IEC 60870-5-104 protocol is given in table 56.

Table 56 – Description of parameters of the IEC 60870-5-104 protocol

Parameter	Description
Protocol name	Name of the protocol
Protocol enabled	Indicator of using the protocol in the configuration
Quantity of clients	Maximum possible quantity of clients (value must be in the range of 1 to 10) simultaneously connected to the device using the IEC 60870--104 protocol

Parameter	Description
Measurement transmission type	It sets the type of analog signal transmission: <ul style="list-style-type: none"> – Cyclic (after a specified time interval); – Sporadic (when signal changes); – Cyclic & sporadic (after a specified time interval and when the signal changes); – Disabled (information is not transmitted)
Client time-out, s	Time interval in seconds (value must be in the range of 1 to 120 s) after which it is considered that there is no connection with the client if no data was received from the client
Measurement data type	It sets the data type of analog signals: <ul style="list-style-type: none"> – Normalized; – Scalable; – Floating point
Sending period, s	Time interval in seconds (value must be in the range of 1 to 900 s) during which the transmission of cyclic measurements is repeated
Analog data*	Analog values / Calculated values / Protection phasors
Binary data*	Logic signals / Binary outputs
Base address of logic signals	Base address of logic signals (value must be in the range of 1 to 16,777,215) according to IEC 60870-5-104 protocol. It is not recommended to change the value without agreement with the developers of device software. Default value is 257
Base address of binary outputs	Base address of binary signals (value must be in the range of 1 to 16,777,215) according to IEC 60870-5-104 protocol. It is not recommended to change the value without agreement with the developers of device software. Default value is 1,281
Base address of analog values	Base address of analog measurements (value must be in the range of 1 to 16,777,215) according to IEC 60870-5-104 protocol. It is not recommended to change the value without agreement with the developers of device software. Default value is 2,561
Basic address of calculated values	Base address of calculated values (value must be in the range of 1 to 16,777,215) according to IEC 60870-5-104 protocol. It is not recommended to change the value without agreement with the developers of device software. Default value is 3,073
Base address of protection phasors	Base address of protection phasors (value must be in the range of 1 to 16,777,215) according to IEC 60870-5-104 protocol. It is not recommended to change the value without agreement with the developers of device software. Default value is 3,329
Transmission mode	Protocol operation mode. By default – Balanced
ASDU address size	By default – 2
Size of transmission reason field	By default – 2
Size of information object address	By default – 3
k Max. quantity of APDU without acknowledgment	Value of k indicates the maximum quantity of consecutively numbered Format I APDUs that can be transmitted without acknowledgment
W Sending an ACK after receiving w APDU	W value is the quantity of APDUs read before an ACK should be sent
ASDU address	By default – 1 ((value must be in the range of 1 to 247)
* It is permitted to select multiple items.	

3.7.13.6.4 IEC 61850 protocol

1) Parameters of the IEC 61850 protocol (figure 116).

Settings / Digital communication channels / Communication protocols / 61850 / Parameters

Parameter	Value	Unit rev.	Description
61850			
Protocol name	61850		
Protocol enabled	<input checked="" type="checkbox"/>		
GOOSE out enabled	<input checked="" type="checkbox"/>		
GOOSE in enabled	<input checked="" type="checkbox"/>		
IED name	IED_EKRA200_TST		
Is extended	<input type="checkbox"/>		
Comtrade file names code page	Windows-1251		

Figure 116 – Parameters of the IEC 61850 protocol

The description of additional parameters of the IEC 61850 protocol is given in table 57.

Table 57 – Description of additional parameters of the IEC 61850 protocol

Parameter	Description
Protocol name	Name of the protocol
Protocol enabled	Indicator of using the protocol in the configuration
Enable outgoing GOOSE	It is planned to exchange binary data between devices via GOOSE messages Data transmission is planned for this device
Enable incoming GOOSE	It is planned to exchange data between IEDs using GOOSE messages. Data reception is planned for this device
IED name	Name (ID) of the device
Sign of using an extended protocol	If a documented possibility of IEC 61850 to add its data types and attributes used
Encoding of COMTRADE file names	Encoding used for COMTRADE file names (Windows-1251 or UTF-8)

2) Parameters of outgoing GOOSE (figure 117).

Settings / Digital communication channels / Communication protocols / 61850 / Outgoing GOOSE

The selection of the active element (s) occurs on the first column



Name	GOOSE class message	Multicast MAC address	AppID (hex)	AppID (dec)	Control block (Control block)	Data set (DataSet)	ID GOOSE (GoID)	Version configuration GOOSE	Normal period of GOOSE transmission, ms	Minimal period of GOOSE transmission, ms
GOOSE_OUT_1	none	01-0c-cd-01-00-3f	33	51	Goose_Out	Discrete	1	1	2000	4

Quantity of messages with a minimal period of transmission, pcs	Twofold increase of period until achieving the period of normal transmission	Quantity of messages with a twofold increase in transmission period, pcs	Enable VLAN	ID VLAN	Priority VLAN	Network interface	Fixed encoding flag
2	<input checked="" type="checkbox"/>	3	<input checked="" type="checkbox"/>	0	4	Ethernet 1	<input type="checkbox"/>

Figure 117 – Parameters of outgoing GOOSE

The description of parameters of outgoing GOOSE is given in table 58.

Table 58 – Description of outgoing GOOSE parameters

Parameter	Function
 	Adding, deleting an outgoing GOOSE message, respectively
Name	Name of outgoing GOOSE message
GOOSE message class	Classes of GOOSE messages: – none; – I (Type 1A); – II (Type 1B); – III (Type 1B)
MAC address	MAC address to which GOOSE packets will be sent
AppID (hex)	Identifier of the application that uses messaging: – hex – hexadecimal representation of the field;
AppID (dec)	– dec – unsigned integer. Must be unique for all GOOSE messages at the substation for proper operation of the device
Control block	Name of control block responsible for GOOSE messaging
DataSet	Name of GOOSE data set
GOOSE ID (GoID)	Unique indicator of an object that distinguishes it from other objects
GOOSE configuration version	Version of GOOSE configuration is necessary to keep track of the number of changes to the GOOSE configuration
Standard GOOSE send period, ms	Period of cyclic sending when there are no signal changes. Periodic sending is used to control the presence of communication. Permissible value range is from 100 to 65,000 ms
Minimum GOOSE send period, ms	Minimum period of cyclic sending in the absence of signal changes. Permissible value range is from 4 to 10,000 ms
Message count with minimum send period, pcs	Quantity of messages with a minimum sending period. Permissible value range is from 2 to 10
Doubled period until standard send period	When the box is checked, the send period is doubled until it reaches the standard sending period. If the box is not checked, the send period is doubled for the number of messages specified in the “Message count with doubled send period” parameter, after which the sending period is immediately taken as equal to the standard
Message count with doubled send period, pcs	Quantity of messages with a doubled sending period. Permissible value range is from 1 to 10
Enable VLAN	Enabling the use of VLAN in outgoing GOOSE messages
VLAN ID	Integer value (0 to 4,095) which is used in VLAN for identification
VLAN priority	Integer priority value for outgoing GOOSE messages using VLAN
Network interface	Ethernet interface through which GOOSE message is sent
Lock encoding	Checkbox for encoding lock

3) Parameters of incoming GOOSE (figure 118).

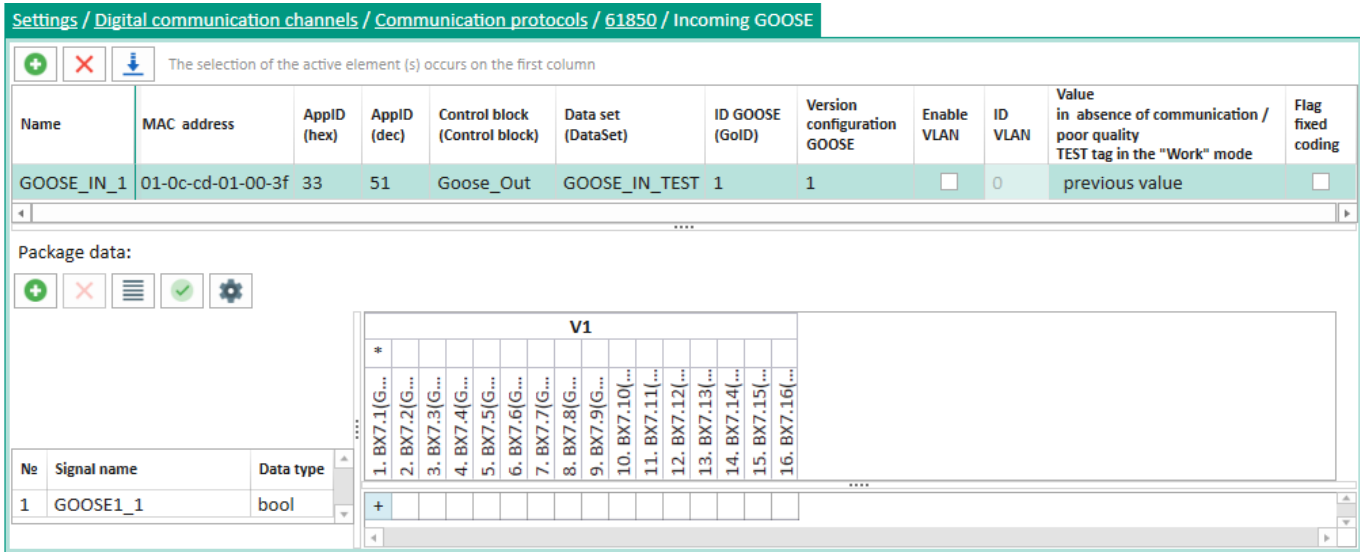

Figure 118 – Parameters of incoming GOOSE

The description of parameters of incoming GOOSE is given in table 59.

Table 59 – Description of parameters of incoming GOOSE

Parameter	Function
	Adding, deleting or importing from the cid file of the incoming GOOSE message, respectively
Name	Name of incoming GOOSE message
MAC address	MAC address from which GOOSE packets will be received
AppID (hex)	Identifier of the application that uses messaging: – hex – hexadecimal representation of the field; – dec – unsigned integer
AppID (dec)	
Control block	Name of control block responsible for GOOSE messaging
Data set	Name of the GOOSE data set. Analogue signals with a time stamp and service ones are not implemented
ID GOOSE (GoID)	Unique indicator of an object that distinguishes it from other objects
GOOSE configuration version	Version of GOOSE configuration is necessary to keep track of the number of changes to the GOOSE configuration
Enable VLAN	Enabling the use of VLAN in incoming GOOSE messages
ID VLAN	Integer value which is used in VLAN for identification
Value for no connection / bad quality / TEST label in non-TEST mode	Value for no connection / bad quality / TEST label in non-TEST mode: – default value; – previous value
Fixed coding checkbox	Enables fixed coding mode for GOOSE packets
	Adding, deleting, editing, activating of input or setting input signals respectively

Parameter	Function
No.	Number of the input signal
Signal name	Name of the input signal
Data type	Type of the input signal data

4) Parameters of incoming SV (figure 119).

No.	svID	MAC
1	EKRAMU0001	010CCD040001

Figure 119 – Parameters of incoming SV

The description of parameters of incoming SV is shown in table 60.

Table 60 – Description of parameters of incoming SV

Parameter	Description
Permissible age of obsolete packets, ms	Permissible age of obsolete packets in milliseconds
No.	Number of SV stream
svID	Identifier of SV stream
MAC	MAC address of SV stream

Note – The availability of this protocol depends on the IED type.

5) Parameters of data sets (figure 120).

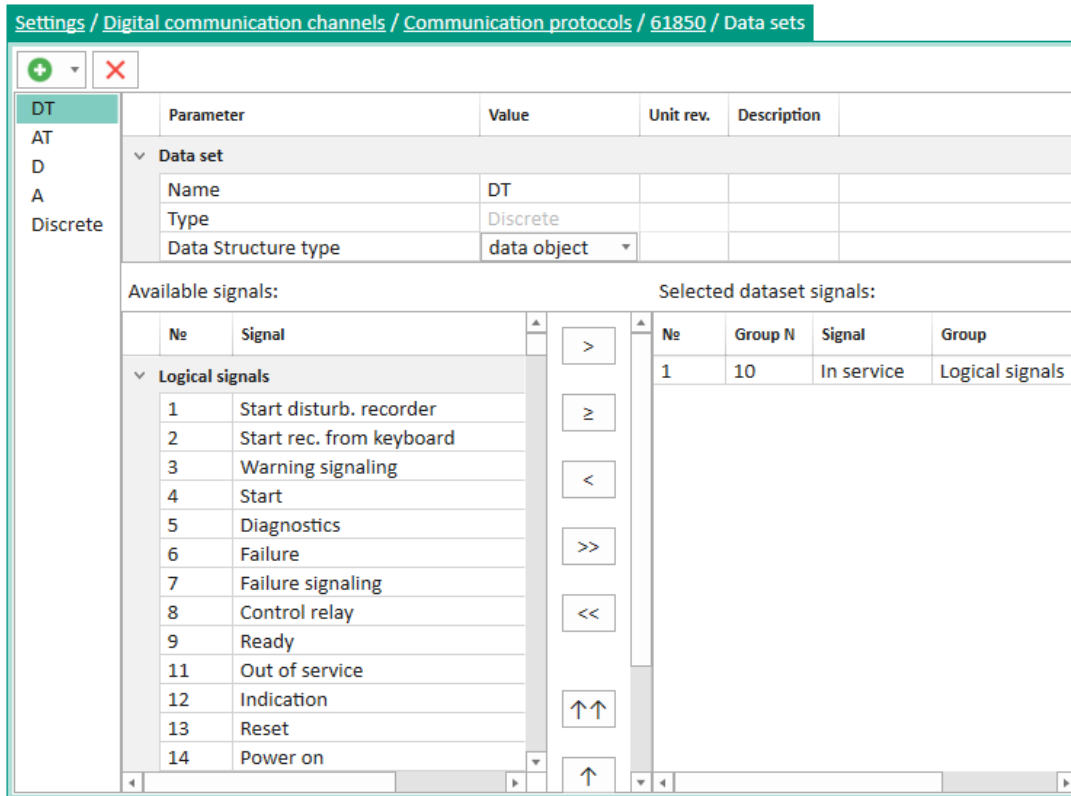

Figure 120 – Parameters of data sets

The description of parameters of data sets is given in table 61.

Table 61 – Description of parameters of data sets

Parameter	Description
Name	Name of the data set
Type	Type of the data set
Data structure type	Type of data structure: – data object; – value; – value, quality; – value, quality, time
	Adding, deleting a data set
Available signals	
No.	Number of the signal
Signal	Name of the signal
Selected data set signals	
No.	Number of the signal
No. in group	Signal number in the group
Signal	Name of the signal

Parameter	Description
Group	Name of the group
> , <	Add, delete selected signals to/from the set, respectively
≥	Add signals in front of the selected one in the set
>> , <<	Add, delete all signals to/from the set, respectively
↑↑ , ↓↓	Move signals up, down 10 positions respectively
↑ , ↓	Move signals up, down one position respectively

6) Parameters of report blocks (figure 121).

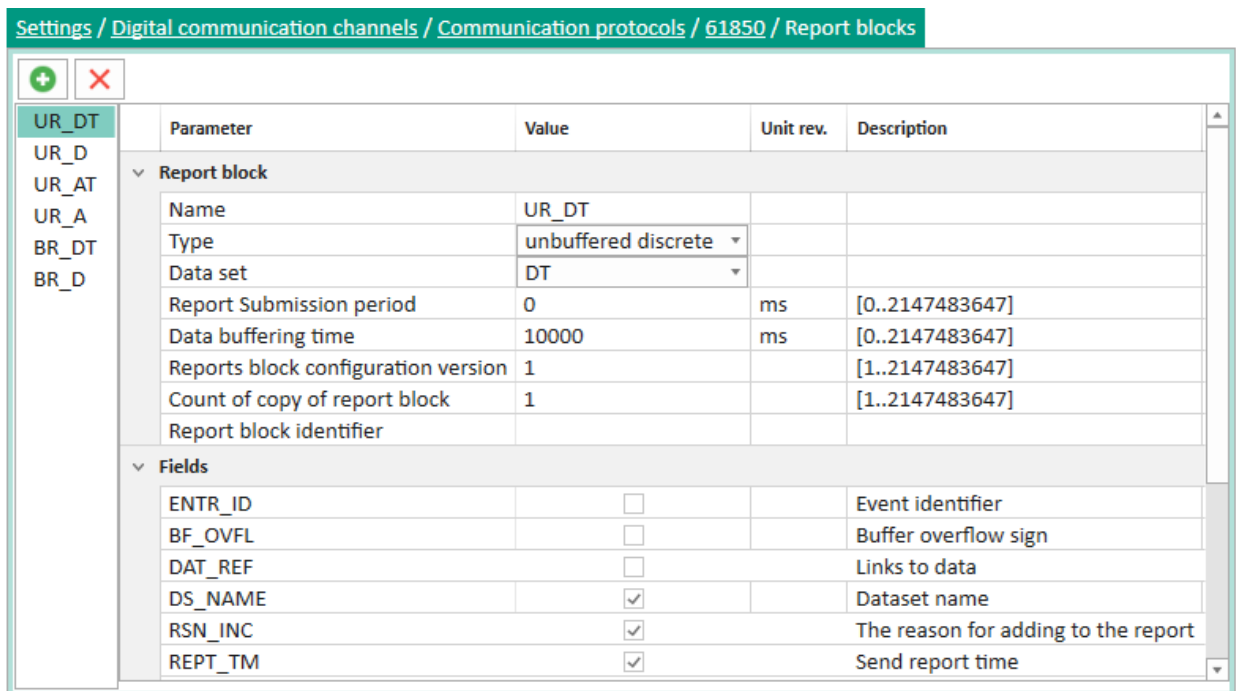

Figure 121 – Parameters of report blocks

Table 62 – Description of report block parameters

Parameter	Function
Parameter	Parameter of the report block
Value	Parameter values
Unit	Measurement unit
Description	Description of parameters
Name	Identifier of the report block
Type: – Unbuffered binary; – Buffered binary;	unbuffered – in the absence of a connection the transmitted data are not stored;

Parameter	Function
<ul style="list-style-type: none"> – Unbuffered analog; – Buffered analog; – Unbuffered service; – Buffered service; – Unbuffered mixed; – Buffered mixed 	buffered – for the period of absence of a connection the data are stored in the volatile memory of the device and transmitted to the client when the connection is restored
Data set	Name of the data set transmitted by the report
Report send time	Time of periodic sending of current values
Data buffering time	Data accumulation time before reporting on signal changes in the data set in milliseconds
Report block configuration version	Version of report block configuration
Report block copy count	Quantity of identical report blocks
Report block identifier	Text designation of the data report block
Fields	List of fields (optional) transmitted in the report
Modes	List of transmission modes

3.7.13.7 User data

The **User data** window (figure 122), device tree menu item **Settings** → **Digital communication channels** → **User data**, is designed for adding user data.

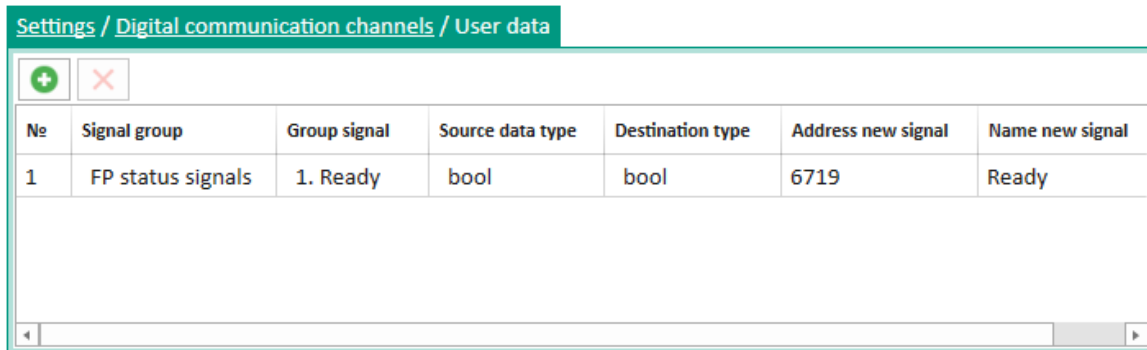



Figure 122 – **User data** window

The description of parameters of the **User data** window is given in table 63.

Table 63 – Description of parameters of the **User data** window

Parameter	Description
No.	Number of the user data element
Signal group	Group to which the user data element belongs
Group signal	Signal based on which the user data element will be generated
Source data type	Type of the source signal data
Destination data type	Type of user data element: – bool;

Parameter	Description
	<ul style="list-style-type: none"> – int8; – int16; – int32; – int64; – uint8; – uint16; – uint32; – uint64; – float; – double
New signal address	Address of the user data element in the ModBus memory map
New signal name	Name of the user data element
 , 	Adding, deleting a signal, respectively

3.7.13.8 Administration of management

The **Administration of management** window (figure 123), device tree menu item **Settings** → **Digital communication channels** → **Administration of management**, is designed for adding IP addresses for device control, setting a name in the **Name** field and an administration level in the **Control level** field.

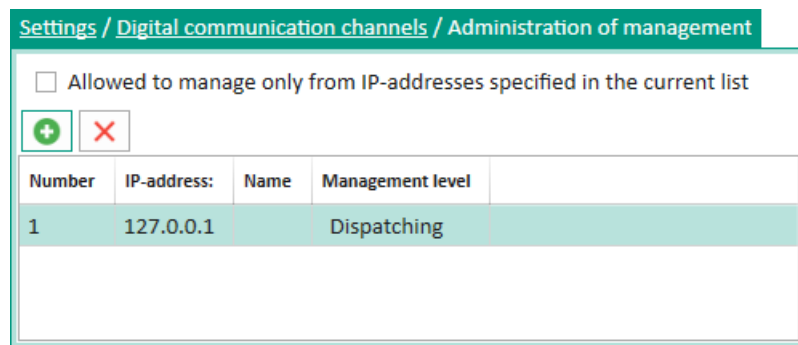



Figure 123 – Administration of management window

The description of parameters of the **Administration of management** window is given in table 64.

Table 64 – Description of parameters of the **Administration of management** window

Parameter	Description
Number	Number of the control administration element
IP address	IP address of the computer
Name	Name of the element
Control level	Levels of device control: <ul style="list-style-type: none"> – Dispatching; – Station
Allowed to manage only from IP addresses specified in the current list	Control is only possible from the IP addresses specified in the list
 , 	Adding, deleting an element, respectively

3.7.14 Transceiver¹⁾

3.7.14.1 General parameters

The **General parameters** window (figure 124), device tree menu item **Settings** → **Transceiver** → **General parameters**, is designed for configuring the main parameters of the receiver and transmitter of the emergency and control signal transmission IED.

Parameter	Value	Unit rev.	Description
Receiver			
Turn on receiver	<input checked="" type="checkbox"/>		
Nominal bandwidth	4	kHz	
The center frequency	257	kHz	
Range	Direct		
Sensitivity	-20	dBm	[-20..10]
HF Attenuator 20 dB is On	<input type="checkbox"/>		
Receiver calibration	7	dB	[-30..30]
Telemechanics	off		
Digital transmission	<input type="checkbox"/>		
Transmitter			
Turn on transmitter	<input checked="" type="checkbox"/>		
Nominal bandwidth	4	kHz	
The center frequency	261	kHz	
Range	Inverse		
Signal command level	38.4	dBo	[0..60]
SS level relative command OS	minus 12	dB	
Telemechanics	off		
Digital reception	<input type="checkbox"/>		
Control			
Start			
Reset			

Figure 124 – **General parameters** window

Parameters of the **General parameters** window are shown in table 65.

Table 65 – Parameters of the **System parameters** window

Parameter	Description
Receiver	
Enable receiver	Enabling or disabling the receiver
Rated bandwidth	Selection of the receiver bandwidth in kHz
Center frequency	Adjusting the center frequency of the receiver in kHz
Spectrum	Selection of spectrum for the receiver bandwidth
Sensitivity	Adjusting sensitivity level of the receiver in dBm

¹⁾ This item is available by default only in teleprotection equipment devices.

Parameter	Description
Attenuator 20 dB	Turn the attenuator on or off by 20 to 22 dB
Receiver calibration	Calibration of the receiver meter in dB
Telemetry	Enabling or disabling the telemetry function
Digital transmission	Enabling or disabling the digital transmission function (digital retransmission)
Transmitter	
Enable transmitter	Enabling or disabling the transmitter
Rated bandwidth	Selection of the transmitter bandwidth in kHz
Center frequency	Adjusting the center frequency of the transmitter in kHz
Spectrum	Selection of spectrum for the transmitter bandwidth
Command signal level	Adjusting the command signal level at the HF output in dBo
SS level relative to command	Adjusting the SS level relative to the command level in dB
Telemetry	Enabling or disabling the telemetry function
Digital reception	Enabling or disabling the digital reception function (digital retransmission)
Control	
Start	Switching the receiver to the "Operation" state
Reset	Reset the IED alarm

Note – The presence or absence of this item depends on the function of the device.

3.7.14.2 Receiver

The **Receiver** window (figure 125), device tree menu item **Settings** → **Transceiver** → **Receiver**, is designed for configuring the parameters of the emergency and control signal transmission receiver commands.

Parameter	Value	Unit rev.	Description		
Parameters					
Security signal frequency	3280	Hz			
Telemechanic frequency	3360	Hz			
Receiver signals					
Add. delay for recognition of all commands, ms <input type="text" value="5"/> <input type="button" value="Set"/>					
Nº	Name	In/Out	Add. recognition delay commands, ms	Frequency 1, Hz	Digital transmission
1	Receive command 1	<input checked="" type="checkbox"/>	0	560	<input checked="" type="checkbox"/>
2	Receive command 2	<input checked="" type="checkbox"/>	0	640	<input checked="" type="checkbox"/>
3	Receive command 3	<input checked="" type="checkbox"/>	0	720	<input checked="" type="checkbox"/>
4	Receive command 4	<input checked="" type="checkbox"/>	0	800	<input checked="" type="checkbox"/>
5	Receive command 5	<input checked="" type="checkbox"/>	0	880	<input checked="" type="checkbox"/>
6	Receive command 6	<input checked="" type="checkbox"/>	0	960	<input checked="" type="checkbox"/>
7	Receive command 7	<input checked="" type="checkbox"/>	0	1040	<input checked="" type="checkbox"/>
8	Receive command 8	<input checked="" type="checkbox"/>	0	1120	<input checked="" type="checkbox"/>
9	Receive command 9	<input checked="" type="checkbox"/>	0	1200	<input checked="" type="checkbox"/>
10	Receive command 10	<input checked="" type="checkbox"/>	0	1280	<input checked="" type="checkbox"/>

Figure 125 – Receiver window

Parameters of the **Receiver** window are shown in table 66.

Table 66 – Parameters of the **Receiver** window

Parameter	Description
Security signal frequency	Adjusting frequency of the security signal in Hz
Telemetry frequency	Adjusting frequency of the telemetry in Hz
Set operate delay for all commands, ms	Entering a receive delay for all HF commands
No.	Number of the HF command of the receiver
Name	Name of the HF command
Enable/Disable	Enabling or disabling the command
Operate delay, ms	Adjusting a receive delay for the HF command
Frequency 1, ms	Adjusting the first frequency of the HF command
Frequency 2, ms	Adjusting the second frequency of the HF command. The second frequency of the HF command is displayed when the two-frequency transmission method is selected in the transceiver module
Digital transmission	Enabling or disabling digital transmission. When digital transmission is enabled, the IED retransmits the received HF command in digital form through the RS-422 port

3.7.14.3 Transmitter

The **Transmitter** window (figure 126), device tree menu item **Settings** → **Transceiver** → **Transmitter**, is designed for configuring parameters of the emergency and control signal transmission transmitter commands.

Parameter	Value	Unit	rev.	Description
Security signal frequency	3280	Hz		
Telemechanic frequency	3360	Hz		
Tracking command without limit	<input type="checkbox"/>			

Transmitter signals

Transfer duration for all commands, ms

No.	Name	Input link	Input name	In/Out	Group	Priority in group	Transferring duration, ms	Tracking command	Frequency 1, Hz	Digital reception
1	Transmit command 1	Block E8, bit 1	Command input 1	<input checked="" type="checkbox"/>	A	1	50	<input type="radio"/>	560	<input checked="" type="checkbox"/>
2	Transmit command 2	Block E8, bit 2	Command input 2	<input checked="" type="checkbox"/>	A	2	50	<input type="radio"/>	640	<input checked="" type="checkbox"/>
3	Transmit command 3	Block E8, bit 3	Command input 3	<input checked="" type="checkbox"/>	A	3	50	<input type="radio"/>	720	<input checked="" type="checkbox"/>
4	Transmit command 4	Block E8, bit 4	Command input 4	<input checked="" type="checkbox"/>	A	4	50	<input type="radio"/>	800	<input checked="" type="checkbox"/>
5	Transmit command 5	Block E8, bit 5	Command input 5	<input checked="" type="checkbox"/>	B	1	50	<input type="radio"/>	880	<input checked="" type="checkbox"/>
6	Transmit command 6	Block E8, bit 6	Command input 6	<input checked="" type="checkbox"/>	B	2	50	<input type="radio"/>	960	<input checked="" type="checkbox"/>
7	Transmit command 7	Block E8, bit 7	Command input 7	<input checked="" type="checkbox"/>	B	3	50	<input type="radio"/>	1040	<input checked="" type="checkbox"/>
8	Transmit command 8	Block E8, bit 8	Command input 8	<input checked="" type="checkbox"/>	B	4	50	<input type="radio"/>	1120	<input checked="" type="checkbox"/>
9	Transmit command 9	Block E8, bit 9	Command input 9	<input checked="" type="checkbox"/>	B	5	50	<input type="radio"/>	1200	<input checked="" type="checkbox"/>
10	Transmit command 10	Block E8, bit 10	Command input 10	<input checked="" type="checkbox"/>	B	6	50	<input type="radio"/>	1280	<input checked="" type="checkbox"/>

Figure 126 – Transmitter window

Parameters of the **Transmitter** window are shown in table 67.

Table 67 – Parameters of the **Transmitter** window

Parameter	Description
Security signal frequency	Adjusting frequency of the security signal in Hz
Telemetry frequency	Adjusting frequency of the telemetry in Hz
“Tracking” command without duration limits	Enabling or disabling the mode of transmission of the “tracking” command without time limit
“Tracking” command level reduction	Enabling or disabling the function to reduce the level of the “tracking” command by 6 dB after 15 s of continuous transmission
Set the duration of transmission for all commands, ms	Entering the duration of transmission for all HF commands
No.	Number of the HF command of the receiver
Name	Name of the HF command
Input binding	Binding of signals occurs by pressing button <input type="button" value="..."/>
Input name	Name of the selected input or logic signal
Enable/Disable	Enabling or disabling the command
Group	Selecting the priority group for the command
Priority in group	Selecting the priority in the group for the command. Commands cannot have the same priorities in the same group
HF command transmission duration, ms	Adjusting the duration of transmission of the HF command

Parameter	Description
“Tracking” command	Enabling or disabling the mode of transmission of the HF command during the time of presence of the operate signal of the bound input
Frequency 1, Hz	Adjusting the first frequency of the HF command
Frequency 2, Hz	Adjusting the second frequency of the HF command. The second frequency of the HF command is displayed when the two-frequency transmission method is selected in the transceiver module
Digital reception	Enabling or disabling digital reception. When digital reception is enabled, the IED receives a digitally retransmitted command through the RS-422 port and generates a command at the HF output

3.7.14.4 Alarm parameters

The **Alarm parameters** window (figure 127), device tree menu item **Settings** → **Transceiver** → **Alarm parameters**, is designed for configuring the parameters of the emergency and control signal transmission IED alarm.

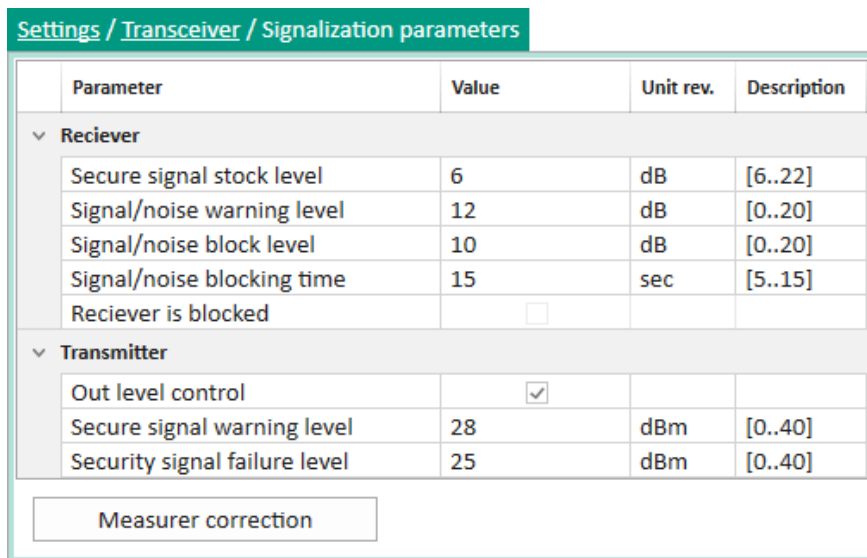

Figure 127 – Alarm parameters window

Parameters of the **Alarm parameters** window are shown in table 68.

Table 68 – Parameters of the **Alarm parameters** window

Parameter	Description
Receiver	
SS margin for warning	Adjusting the warning margin in dB. When the margin of the SS level reduces, warning alarm operates
SNR threshold for warning	Adjusting the warning threshold of SNR in dB. When the SNR level reduces below this threshold, the receiver is blocked and failure alarm operates
SNR threshold for blocking	Adjusting the SNR threshold for blocking the receiver in dB. When the SNR level reduces below this threshold, warning alarm operates
Receiver blocking	Enabling or disabling the receiver block function. Disabling the blocking makes the command reception window unlimited

Parameter	Description
Transmitter	
Output level control	Enabling or disabling HF output signal level control function
SS threshold for warning	Adjusting the warning threshold of SS in dBm. When the SS level at the HF output reduces below this threshold, warning alarm operates
Meter correction	Opens the HF output signal meter calibration window

3.8 Saving settings report

Settings report is a file containing information about the configuration. Unlike *.czg files, this file is more readable and not used by the device.

The operation of saving the report on settings can be activated using command **Reports** → **Settings report** on the control panel. When executing the command, it is necessary to specify the save directory and file name.

3.9 Writing settings

Settings can be written to the device using command . When the command is executed, the settings specified in the Smart Monitor program will be written to the device. The command is not active if there are no changes in the device setting.

After writing the settings, the current open window will be updated and new settings will be loaded.

3.10 Updating settings

The settings update button , which is available on the toolbar of the main program window, is designed for forced update of settings. When this command is executed, current settings are loaded from the device and displayed in the Smart Monitor program.

3.11 Saving data report via IEC 61850-8-1 protocol

In order to generate a list of binary signals and analog measurements of the device available via 61850 protocol, it is necessary to generate a corresponding report (**Reports** → **IEC 61850-8-1 protocol data**). The report file is downloaded from the device in *.xml format.

3.12 Generating signals list via Modbus

In order to generate a list of binary signals and analog measurements of the device available via Modbus protocol, it is necessary to generate a corresponding report (**Reports** → **Modbus data description**). In order to generate a report Microsoft Excel is required.

When generating reports in Excel format, it must be taken into account that Engineering functions must be connected. All functions in this category are available in versions of Excel earlier than 2007 only after connecting the Analysis ToolPak add-in.

An example of a report is shown in figure 128.

1
Cabinet: 2
Protected facility: 2
IED(s) address: 1, 2

Group 2 - Signals from protections and input circuits (Matrix inputs):

No.	Address in functional diagram	Signal name	Designation on functional diagram (FD)	Recording	Event No. in group	Word No.	Bit No. in word	Address in ModBus /RTU	PLC address	Do not use. Left for old projects		Alarm type	Protected sub-facilities
										Address in ModBus /RTU	PLC address		
1	?1	Start disturb. recorder	Start disturb. recorder	+	0		0						
2	?2	Start rec. from keyboard	Start rec. from keyboard	+	1		1						
3	?3	Warning signaling	Warning signaling	+	2		2						
4	?4	Start	Start	-	3		3						
5	?5	Diagnostics	Diagnostics	+	4		4						
6	?6	Failure	Failure	+	5		5						
7	?7	Failure signaling	Failure signaling	+	6		6						
8	?8	Control relay	Control relay	-	7	0	7	100000	1448577	080F	42064		
9	?9	Ready	Ready	+	8		8						
10	?10	In service	In service	+	9		9						
11	?11	Out of service	Out of service	+	10		10						
12	?12	Indication	Indication	+	11		11						
13	?13	Reset	Reset	-	12		12						
14	?14	Power on	Power on	+	13		13						
15	?15	Synchronization	Synchronization	-	14		14						
16	?16	LEDs diagnostics	LEDs diagnostics	-	15		15						

Figure 128 – Example of the **Modbus data description report**

3.13 Generating settings report in Excel

To generate a report on settings in Excel format, it is necessary to generate a corresponding report (**Reports** → **Settings report in Excel**). An example of a report is shown in figure 129. The Excel report contains measuring element settings and a tripping matrix.

In order to create a detailed settings report, it is necessary to use report generation function in text form.

Matrix output (M)	Matrix inputs (I)	Output name	Input name
V1.1 POWER_SUPPLY_BREAKER	Automatic breaker of power supply bus	Automatic breaker of power supply bus	
V1.2 CB_TRUCK_ROLLED_IN	CB Truck rolled in	CB Truck rolled in	
V1.3 DRIVE_NOT_READY	Drive not ready	Drive not ready	
V1.4 CONTROL_BLOCK	Blocking of control	Blocking of control	
V1.5 CB_OPENED	CB opened position	CB opened position	
V1.6 CB_CLOSED_1	CB closed position 1	CB closed position 1	
V1.7 CB_CLOSED_2	CB closed position 2	CB closed position 2	
V1.8 CMD_OPEN	CB command open	CB command open	
V1.9 CMD_CLOSE	CB command close	CB command close	
V1.10 VT_BREAKER	Automatic breaker of voltage transformer	Automatic breaker of voltage transformer	
V1.11 ARC_1_OPERATE	Operate of ARC 1 protection	Operate of ARC 1 protection	
V1.12 EXT_OPERATE_1	Operate of External protection 1	Operate of External protection 1	
V1.13 EXT_CBFP	External CB Failure Protection	External CB Failure Protection	
V1.14 CB-1_truck_rolled_out	CB truck rolled out	CB truck rolled out	
V1.15 Reserve	Reserve	Reserve	
V1.16 Emergency_Deblocking	Emergency deblocking	Emergency deblocking	
V2.1 3U< BLOCK	Blocking of Undervoltage protection	Blocking of Undervoltage protection	
V2.2 EFP_MODE	Mode of Earth fault protection	Mode of Earth fault protection	
V2.3 VCS	Voltage-controlled start	Voltage-controlled start	
V2.4 VT_FAIL	Voltage transformer failure	Voltage transformer failure	
V2.5 ARC_CURRENT_CONTROL	Current control for ARC protection	Current control for ARC protection	
V2.6 ARC_2_OPERATE	Operate of ARC 2 protection	Operate of ARC 2 protection	
V2.7 ARC_1_ALARM	Alarm signal of ARC 1 protection	Alarm signal of ARC 1 protection	
V2.8 ARC_2_ALARM	Alarm signal of ARC 2 protection	Alarm signal of ARC 2 protection	
V2.9 EXT_OPERATE_2	Operate of External protection 2	Operate of External protection 2	
V2.10 EXT_OPERATE_3	Start of Loss of power protection on backup feeder	Start of Loss of power protection on backup feeder	
V2.11 CBFP_DISABLE	Disable of CB Failure Protection	Disable of CB Failure Protection	
V2.12 CONTROL_REMOTE	Remote control mode	Remote control mode	
V2.13 REMOTE_OPEN	CB Open command by remote area	CB Open command by remote area	
V2.14 REMOTE_CLOSE	CB Close command by remote area	CB Close command by remote area	
V2.15 BLINKING_RESET	Reset of blinking scheme	Reset of blinking scheme	
V2.16 BLOCK_CLOSE	Blocking of CB Close	Blocking of CB Close	
V3.1 U_PRESENCE	Normal voltage level	Normal voltage level	
V3.2 AR_DISABLE	Anable of Autoreclose	Anable of Autoreclose	
V3.3 UFLS	Underfrequency load shedding	Underfrequency load shedding	
V3.4 FAAR	Frequency-actuated autoreclose	Frequency-actuated autoreclose	
V3.5 FAAR_BLOCK	Blocking of Frequency-actuated autoreclose	Blocking of Frequency-actuated autoreclose	
V3.6 AR1_DISABLE	Disable of Autoreclose function 1	Disable of Autoreclose function 1	
V3.7 AR2_DISABLE	Disable of Autoreclose function 2	Disable of Autoreclose function 2	
V3.8 GP_OPERATE	Operate of Gas protection	Operate of Gas protection	
V3.9 GP_ALARM	Alarm signal of Gas protection	Alarm signal of Gas protection	
V3.10 GP_MODE	Mode of Gas protection	Mode of Gas protection	

Figure 129 – Example of a settings report in Excel

3.14 Generating signals list for transmission via OPC protocol

In order to generate a list of binary signals available for transmission via OPC protocol, it is necessary to generate a corresponding report (**Reports** → **List of signals in PCS (OPC identifiers)**). The OPC identifiers of binary signals of the device will be presented in the report. An example of a report is shown in figure 130.

List of PCS signals from protection cabinets of generator-transformer unit of ED2-F-09-017-V325 type No.1 (OPC-identifiers)						
No.	Protection	Designation on FD	Name	Signal code		
				System A	System B	
Section input						
Alarm signals						
1	Three-phase undervoltage measuring element (line voltage)	3U<(2)	Undervoltage blocking	ED2-F-09-017-V325_1355.IMOS.B083	ED2-F-09-017-V325_1356.IMOS.B083	
2			3U<(1) operate	ED2-F-09-017-V325_1355.IMOS.B084	ED2-F-09-017-V325_1356.IMOS.B084	
3			operate	ED2-F-09-017-V325_1355.IMOS.B085	ED2-F-09-017-V325_1356.IMOS.B085	
Warning signals						
4	Three-phase undervoltage measuring element (line voltage)	3U<(5)	Input	ED2-F-09-017-V325_1355.IMOS.B056	ED2-F-09-017-V325_1356.IMOS.B056	
5			Oper.	ED2-F-09-017-V325_1355.IMOS.B057	ED2-F-09-017-V325_1356.IMOS.B057	
6	Three-phase undervoltage measuring element (line voltage)	3U<(1)	Input	ED2-F-09-017-V325_1355.IMOS.B075	ED2-F-09-017-V325_1356.IMOS.B075	
7			Oper. AB	ED2-F-09-017-V325_1355.IMOS.B076	ED2-F-09-017-V325_1356.IMOS.B076	
8			Oper. BC	ED2-F-09-017-V325_1355.IMOS.B077	ED2-F-09-017-V325_1356.IMOS.B077	
9			Oper. CA	ED2-F-09-017-V325_1355.IMOS.B078	ED2-F-09-017-V325_1356.IMOS.B078	
10	Three-phase undervoltage measuring element (line voltage)	3U<(2)	Input	ED2-F-09-017-V325_1355.IMOS.B079	ED2-F-09-017-V325_1356.IMOS.B079	
11			Oper. AB	ED2-F-09-017-V325_1355.IMOS.B080	ED2-F-09-017-V325_1356.IMOS.B080	
12			Oper. BC	ED2-F-09-017-V325_1355.IMOS.B081	ED2-F-09-017-V325_1356.IMOS.B081	
13			Oper. CA	ED2-F-09-017-V325_1355.IMOS.B082	ED2-F-09-017-V325_1356.IMOS.B082	
14	Three-phase undervoltage measuring element (line voltage)	3U<(4)	Input	ED2-F-09-017-V325_1355.IMOS.B093	ED2-F-09-017-V325_1356.IMOS.B093	
15			Oper. AB	ED2-F-09-017-V325_1355.IMOS.B094	ED2-F-09-017-V325_1356.IMOS.B094	
16			Oper. BC	ED2-F-09-017-V325_1355.IMOS.B095	ED2-F-09-017-V325_1356.IMOS.B095	
17			Oper. CA	ED2-F-09-017-V325_1355.IMOS.B096	ED2-F-09-017-V325_1356.IMOS.B096	
18			Voltage presence control	ED2-F-09-017-V325_1355.IMOS.B097	ED2-F-09-017-V325_1356.IMOS.B097	
19			Voltage absence control	ED2-F-09-017-V325_1355.IMOS.B098	ED2-F-09-017-V325_1356.IMOS.B098	

Figure 130 – Example of a report **List of signals in PCS (OPC identifiers)**

3.15 Generating signals list for transmission via IEC 60870-5-103 protocol

In order to generate a list of signals available for transmission via IEC 60870-5-103 protocol, it is necessary to generate a corresponding report (**Reports** → **IEC 60870-5-103 protocol data**). An example of a report is shown in figure 131.

ASDU 4 format (clause 7.3.1.4 of GOST R IEC 60870-5-103-2005)
 The current measurement value is represented in floating point format.

Analog measurements

No.	Function number (FUN)	Information number (INF)	Measurement designation
1	10	1	I1 A
2	10	2	I1 B
3	10	3	I1 C
4	10	4	I2 A
5	10	5	I2 B
6	10	6	I2 C
7	10	7	Uo
8	10	8	U A
9	10	9	U B
10	10	10	U C
11	10	11	U1
12	10	12	U2
13	10	13	IDC 1
14	10	14	IDC 2
15	10	15	IDC 3
16	10	16	IDC 4
17	10	17	IDC 5
18	10	18	IDC 6
19	10	19	IDC 7
20	10	20	IDC 8
21	10	21	IDC 9
22	10	22	I mA 1
23	10	23	I mA 2
24	10	24	I mA 3
25	10	25	ISV A
26	10	26	ISV B
27	10	27	ISV C
28	10	28	ISV N
29	10	29	U SV A
30	10	30	U SV B
31	10	31	U SV C
32	10	32	U SV N

Figure 131 – Example of a report IEC 60870-5-103 protocol data

3.16 Generating signals list for transmission via IEC 60870-5-104 protocol

In order to generate a list of signals available for transmission via IEC 60870-5-104 protocol, it is necessary to generate a corresponding report (**Reports** → **IEC 60870-5-104 protocol data**). An example of a report is shown in figure 132.

Research & production enterprise "EKRA", Ltd ED2-BC-09-242-V010			
Binary signals of protocol 60870-5-104			
These signals are transmitted via ASDU 30 (p. 7.3.1.22 IEC 60870-5-101) Size of information object address field is 3 bytes. Signal value is represented by SPI bit of SIQ field with size of 1 byte (p. 7.2.6.1 IEC 60870-5-101).			
No.	Event name	Information object address	Note
<i>Group 1. Logical signals</i>			
1	Start disturb. recorder	257	
2	Start rec. from keyboard	258	
3	Warning signaling	259	
4	Diagnostics	261	
5	Failure	262	
6	Failure signaling	263	
7	Control relay	264	
8	Ready	265	
9	In service	266	
10	Out of service	267	
11	Indication	268	
12	Reset	269	
13	Power on	270	
14	1	273	
15	2	274	
16	3	275	

Figure 132 – Example of a report **IEC 60870-5-104 protocol data**

3.17 Importing settings

The window for importing settings from a file is activated through the main menu  → **Import settings from xml**. Then, select the configuration file using the **Open** button.

3.18 Generating files to send

The **Generate files to send** command is designed to generate an archive file containing files downloaded from the device, as well as Smart Monitor service files from the user's local machine. In case of emergency situations, the generated archive is designed to be sent to the technical support service for further analysis and identification of the causes of device malfunctions.

To generate files to send, it is necessary to activate item  → **Generate files to send**. Then, select a location for saving and click the **Save** button.

3.19 Possible failures

Causes of errors when establishing connection:

1) The operating system does not have the Modbus TCP/IP protocol installed. In this case, it is necessary to close the program, activate the **Control panel**, select the **Network** shortcut and install the Modbus TCP/IP protocol.

2) A message may appear saying “The computer with the IP address of the communication server specified in the object structure description file is not found”. In this case, it is necessary to make sure that the PC with which you want to establish a connection is working, and check that the name or IP address of this PC is set correctly. Another possible reason for the above messages to appear is that when configuring the Modbus TCP/IP protocol on the local computer, the IP address of this PC was not set.

3) It may turn out that a PC at the specified name or IP address is found, but the PC is using a different TCP port than that specified in the program. In this case, it is necessary to determine which TCP port is used to connect to the program.

If there are any difficulties please address system administrator of the company LAN.

4 Description of Configurator interface

The Configurator program is designed to create and edit off-line configurations of devices based on ED2 series devices.

The Configurator program has a graphic interface as user interface.

The type of interface used by the program is a standard MDI type interface with support for Drag&Drop technology, which has one main window containing several child ones. Child windows contain the main functionality of the program. In accordance with the standards for Windows applications, the main window contains the main menu and a toolbar.

This section contains a description of the graphic environment of the program and its main components.

3.1 Start

The program is started using menu **Start** → **All programs** → **EKRA** → **Configurator**.

3.2 Shutdown

The program is shutdown in the standard ways for Windows applications:

- through menu **File** → **Exit**;
- by clicking  on the title bar of the main window.

3.3 Title of main window

The title text of the window consists of the name of the program, version of the program, type of the edition of the program and has a form shown in figure 133, item 1.

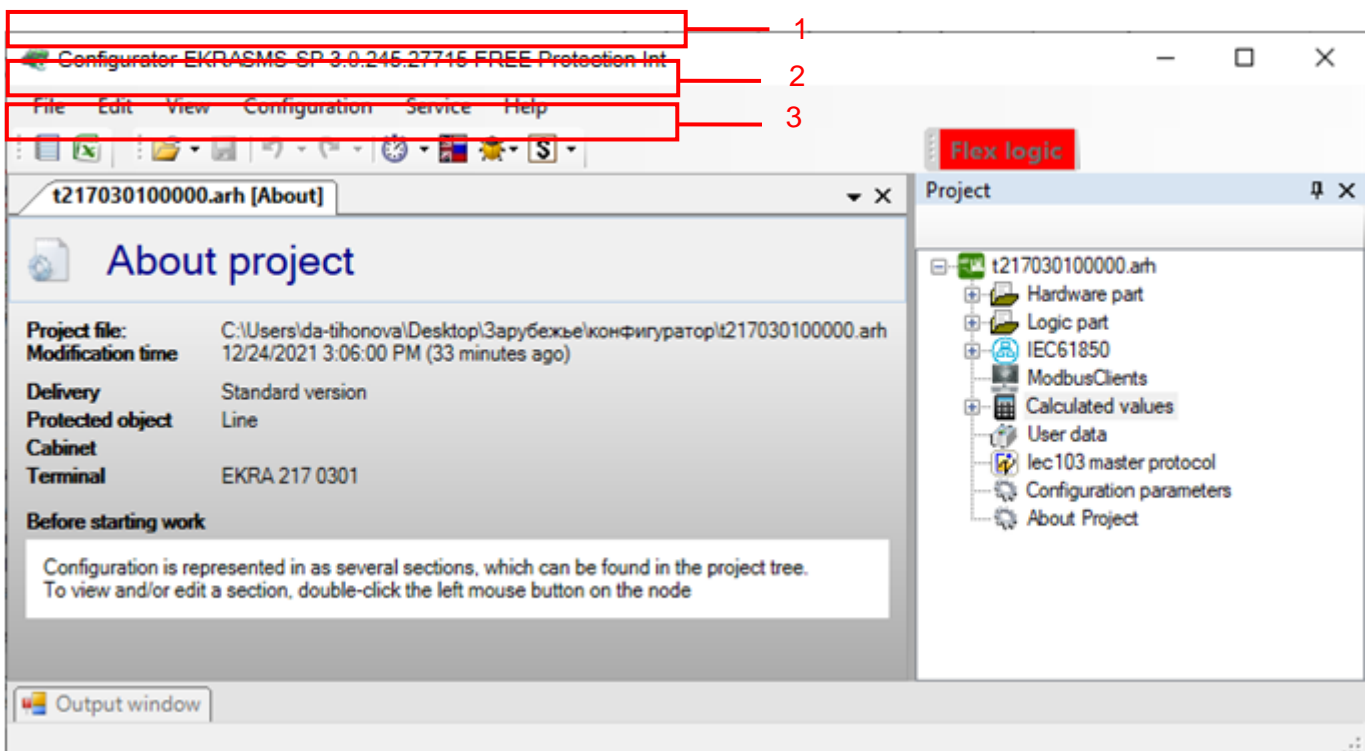

Figure 133 – Main window of the Configurator program

3.4 Main menu

The main menu is located under the title bar of the main menu and has a form shown in figure 133, item 2.

Each item on the main menu has a submenu associated with it. The submenu appears when the corresponding item of the main menu is selected (by pressing the left mouse button on the menu item). For some sub-items, hot keys are also indicated.

3.4.1 File menu

Commands of the **File** menu are shown in table 69.

Table 69 – Commands of the **File** menu

Command	Description
Open project...	Opening the current configuration
Close project	Closing the current configuration
Save Ctrl+S	Saving the current configuration
Save as	Saving the current configuration with a location and name
Recent project	Displaying and opening recent projects
Exit	Exiting the program

3.4.2 Edit menu

Commands of the **Edit** menu are shown in table 70.

Table 70 – Commands of the **Edit** menu

Command	Description
Undo Ctrl+Z	Undo a previous action
Redo Ctrl+Y	Redo an undone action
Action control	Enables/disables rollback of actions
Logging	Writing logs to a file

3.4.3 View menu

Commands of the **View** menu are shown in table 71.

Table 71 – Commands of the **View** menu

Command	Description
Library window	Displaying the library of modules available for the project (you must be on the Modules form in the project tree to display it)
Project tree	Displaying the project tree
Output window	Displaying the window of message output

Command	Description
Imported data sets	Displaying the window of imported data sets
Logic library	Viewing the logic library with possible addition of elements to the Logic form
Configuration errors	Displaying the window of configuration errors
Special characters table	Displaying the table of special characters
Logic	Checking the "Display grid" box activity

3.4.4 Configuration menu

Commands of the **Configuration** menu are shown in table 72.

Table 72 – Commands of the **Configuration** menu

Command	Description
Check configuration integrity	Check the configuration for errors. There is a certain set of rules that the configuration must comply with. If the configuration does not comply with the specified rules, then an incorrect configuration message will be displayed and it will need to be corrected

3.4.5 Service menu

Commands of the **Service** menu are shown in table 73.

Table 73 – Commands of the **Service** menu

Command	Description
Reports	Generation of reports: <ul style="list-style-type: none"> – Modbus data description; – Settings report; – Settings report in Excel; – List of signals APCS (OPC IDs); – IEC 60870-5-103 protocol data; – IEC 60870-5-104 protocol data; – IEC 61850-8-1* protocol data; – Settings sheet
Settings	Selection of program language: <ul style="list-style-type: none"> – Russian (ru); – English (en); – Spanish (es) Associate *.czg and *.arh
* To create a report, go to the window.	

3.4.6 Help menu

Commands of the **Help** menu are shown in table 74.

Table 74 – Commands of the **Help** menu











Command	Description
About	Displaying the name of the program, version of the program, hardware code

3.5 Toolbar

The toolbar provides an alternative way to access the most commonly used commands (figure 133, item 3).

Toolbar commands are shown in table 75.

Table 75 – Toolbar commands

View	Name
	Open
	Save
	Undo
	Redo
	Autosave (at specified interval)
	Language localization (used to set parameter names for each language of the created configuration)
	DebugInfo (Displaying additional information of logical nodes on the logic diagram)
	Settings display mode (primary/secondary values)
	Settings report...
	Settings report in Excel

Notes

1 Some forms have additional tools which are dynamically added to the main toolbar.

2 When generating reports in Excel format, it must be taken into account that **Engineer functions** must be connected. These functions are used in engineering and scientific calculations. All functions of this category are available in Excel versions earlier than 2007 only after connecting **Analysis ToolPak** add-in.

3.6 Output window and status bar

3.6.1 Output window

The output window (figure 134), menu item **View** → **Output window**, is designed to display messages about the progress of the program. To view the contents of the window, hover the mouse pointer over the window or open it through the menu.

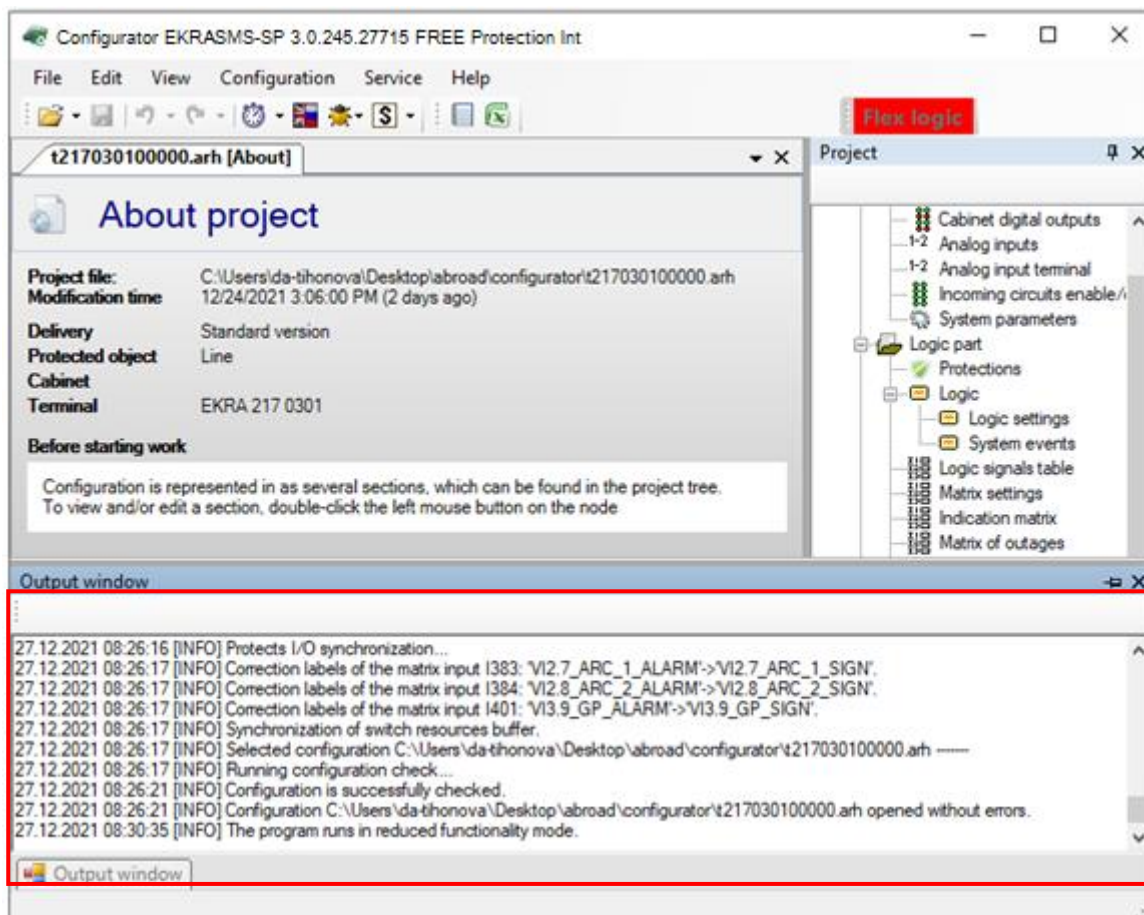

Figure 134 – Output window

3.6.2 Status panel

The status panel (figure 135) is designed to display intermediate information about the progress of the program to the user.

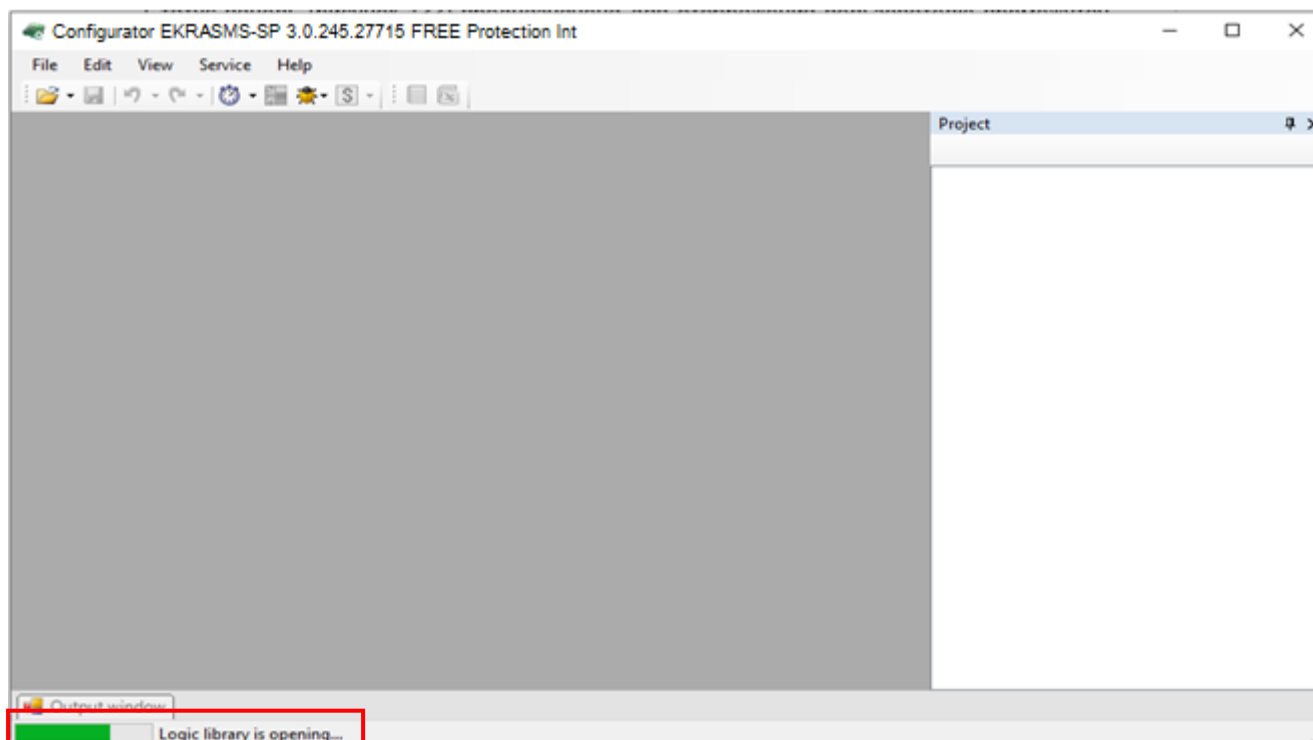

Figure 135 – Status panel of the Configurator program

5 Description of work with Configurator program

5.1 Description of Configurator editions

The following acronyms are used in table 76:

- X – the function is available in full;
- Y – the function is available, but with limitations. Limitations are described;
- “–” – the function is not available.

Table 76 – Description of editions

Configurator program edition		Free Protection Int	Free Bay Controller Int
Device functionality code		Protection Int	Bay Controller Int
Distribution terms		The edition is selected automatically when opening a configuration with the corresponding functional purpose code and does not require additional settings	
Options	Changing composition of hardware modules	Y (Available only for indication modules)	Y (Available only for indication modules)
	Changing composition of virtual software input/output modules	X	X
	Switching devices	Y (It is inhibited to add new SDs; it is inhibited to edit the SD “Type” parameter)	X
	Configuring device system settings	X	X
	Configuring programmable logic	X	X
	Adding new functions and measuring elements	–	–
	Setting parameters of functions and measuring elements	X	X
	Configuring all communication protocols available in project	X	X
	Editing signals table	X	X
	Ranking matrix of output relays	X	X
	Ranking matrix of LEDs	X	X
	Mimic diagram	X	X
	Creating display pages and icons	X	X
	Setting parameters of event and disturbance recorder	X	X
Comparing setting groups	X	X	
Calculated values	Y (It is inhibited to add new calculated values)	X	

5.2 Opening, saving project configuration

5.2.1 Project opening

An existing project is opened through menu **File** → **Open project** or by clicking button  on the toolbar.



NOTICE

The project must be opened with the measuring element library file with which it was created!

After opening, a project tree will be added (figure 136, item 1) and the default form **About** will open (figure 136, item 2). When opening subsequent projects, they will be added to the project tree in the same way. There are no limitations on the quantity of simultaneously open projects.

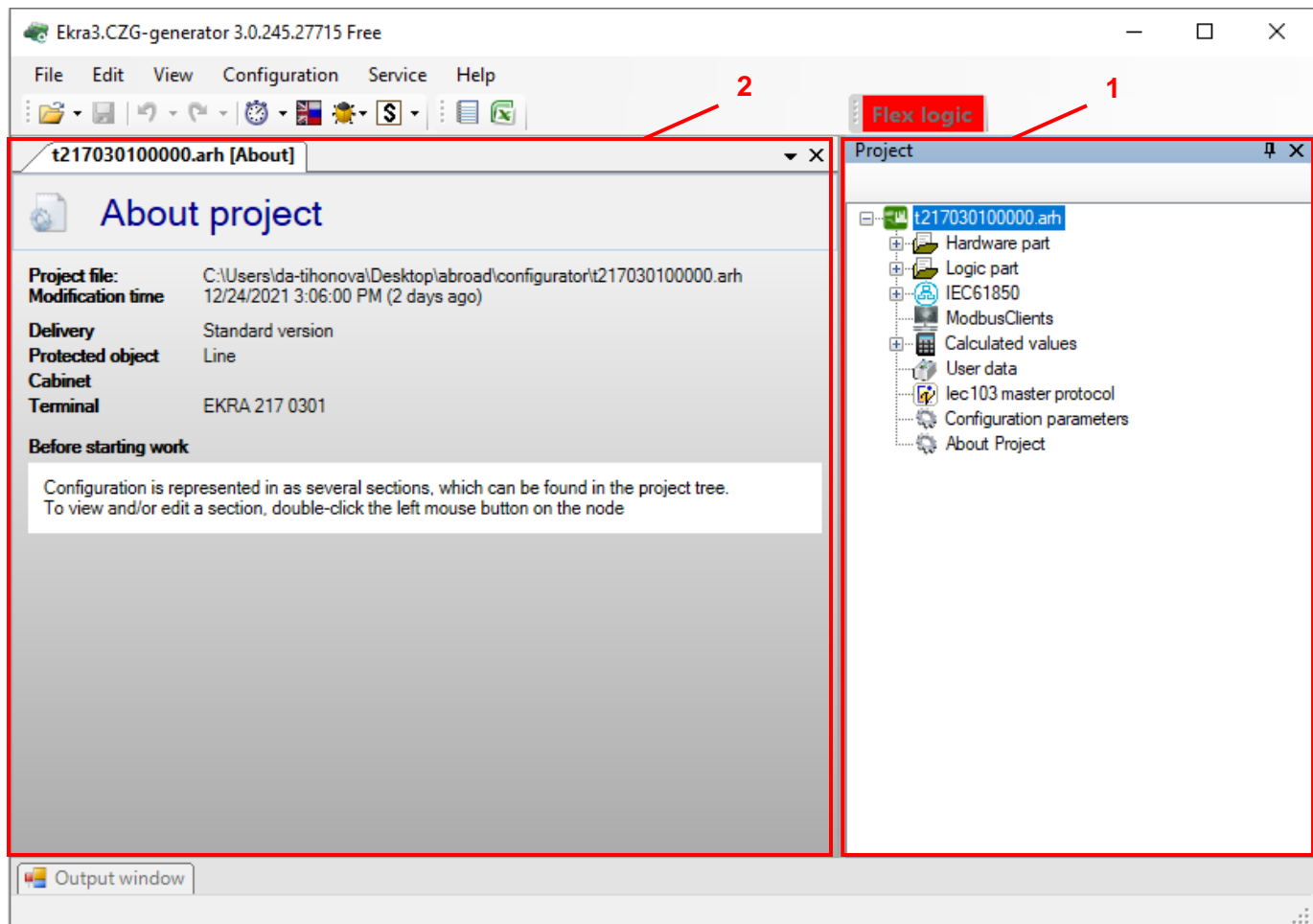



Figure 136 – Main window of the Configurator program

The recommended order for entering data and parameters when creating a configuration is shown in table 77.

Table 77 – Order of configuration formation

Part	Configuration parameter
Hardware part	Modules
	Cabinet digital outputs
	Analog inputs
	Terminal block of analog inputs
	Binary input
	Switching device remaining life
	System parameters
Software (logic) part	Measuring elements
	Logic
	IED signals table
	Matrix of binary outputs
	Indication matrix
	Tripping matrix
	Event recorder
	Disturbance recorder
	Measurements for indication
	Mimic diagram
	Management
	Differences by setting groups
IEC 61850	Outgoing GOOSE
	Incoming GOOSE
	Data sets
	Report blocks
	Data model

5.2.2 Saving project

The project is saved through menu **File** → **Save Ctrl+S** or through menu **File** → **Save as**, or by clicking button  on the toolbar. When you close the main window of the program or the project tree, a confirmation window will open for saving changes if the configuration was changed during work (figure 137). When saving the project, the logic is recompiled if changes were made to it during work.

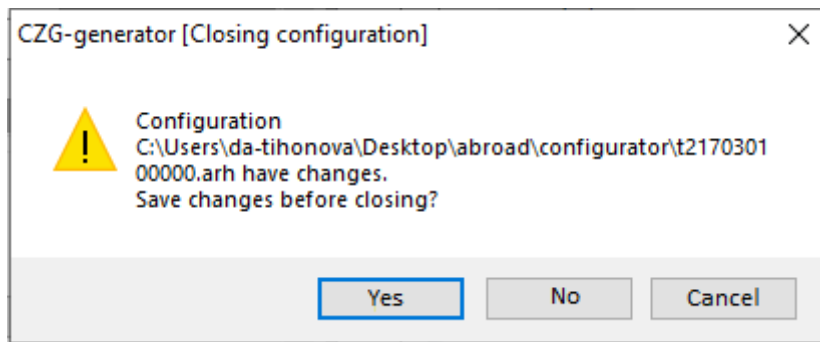

Figure 137 – Configuration closing

5.3 Hardware part

5.3.1 Modules

The **Modules** window, device tree menu **Hardware part** → **Modules**, is designed for configuring hardware (physically existing modules in the IED) and virtual (used to expand functionality) IED modules in accordance with order requirements.

5.3.1.1 General parameters of modules

For all types of modules, there are general parameters for configuration (figure 138).

General parameters	
Parameter	Value
Name	E1
Library block	L2661 (Controller module)
Cassete	A1
The address of block on the bus	5

Figure 138 – General parameters of modules

The description of general parameters is given in table 78.

Table 78 – General parameters of modules

Parameter	Description	Limitation
Name	Name of the module	For all types of modules
Library module	Name of the module in the logic library	
Cassete	Selection of the IED cassette	Only for hardware modules
Module address on bus	Address of the module on the IED bus	

5.3.1.2 Specific parameters of modules

5.3.1.2.1 Input/output module (Combined module) (figure 139)

Module of binary inputs/outputs (Combined module) receives binary signals from external devices and switches external control and alarm circuits.

Block signals				
Nº	Name	Oper.DT, ms	Return.DT, ms	Relay action
1	Relay 65	0	0	<input checked="" type="checkbox"/>
2	Relay 66	0	0	<input checked="" type="checkbox"/>
3	Relay 67	0	0	<input checked="" type="checkbox"/>
4	Relay 68	0	0	<input checked="" type="checkbox"/>
5	Relay 69	0	0	<input checked="" type="checkbox"/>
6	Relay 70	0	0	<input checked="" type="checkbox"/>
7	Relay 71	0	0	<input checked="" type="checkbox"/>
8	Relay 72	0	0	<input checked="" type="checkbox"/>
9	Input 1	15	6	<input type="checkbox"/>
10	Input 2	15	6	<input type="checkbox"/>
11	Input 3	15	6	<input type="checkbox"/>
12	Input 4	15	6	<input type="checkbox"/>
13	Input 5	15	6	<input type="checkbox"/>
14	Input 6	15	6	<input type="checkbox"/>
15	Input 7	15	6	<input type="checkbox"/>
16	Input 8	15	6	<input type="checkbox"/>

Figure 139 – Signals of input/output module (combined module)

The description of bit parameters of the combined module is given in table 79.

Table 79 – Description of parameters of combined module signals

Parameter	Description
No.	Number of the signal
Name	Signal name in the configuration
Oper.DT, ms	Time delay for operate in milliseconds
Return DT, ms	Time delay for release in milliseconds
Relay action	Indicator of relay presence (only for modules with output relays)

5.3.1.2.2 Module of virtual analog inputs (figure 140)

The virtual analog input module is designed to convert analog input current and voltage signals into digital data and transmit them to the logic module for further processing.

#	Name of in. val.	Input type of in. val.	Max value of in. val.	Coeff. trans. to C system
1	Igoose 1	Current	100	1
2	Igoose 2	Current	100	1

Figure 140 – Parameters of virtual analog input module

The description of parameters of virtual analog inputs is given in table 80.

Table 80 – Description of parameters of virtual analog inputs

Parameter	Description
No.	Sequence number of the input value
Name of input value	Name of the input value
Type of input value	Type of the input value – Voltage; – Current
Max. input value	Maximum input value
SI reduction factor	Factor of reduction to SI system (B, A). By default – 1

5.3.1.2.3 Module of virtual inputs (figure 141)

The virtual inputs module is designed to receive binary signals via digital communication channels. Reception of signals is available via IEC 61850, IEC 60870-5-103 and Modbus protocols.

Block signals	
<input type="checkbox"/>	Pulse mode
Nº	Name
1	Input GOOSE 1_1
2	Input GOOSE 1_2
3	Input GOOSE 1_3
4	Input GOOSE 1_4
5	Input GOOSE 1_5
6	Input GOOSE 1_6
7	Input GOOSE 1_7
8	Input GOOSE 1_8
9	Input GOOSE 1_9
10	Input GOOSE 1_10
11	Input GOOSE 1_11
12	Input GOOSE 1_12
13	Input GOOSE 1_13
14	Input GOOSE 1_14
15	Input GOOSE 1_15
16	Input GOOSE 1_16

Figure 141 – Signals of virtual inputs module

The description of virtual input modules parameters is given in table 81.

Table 81 – Description of virtual input modules parameters

Parameter	Description	Limitation
No.	Number of the signal in the module	For all software digital inputs modules
Name	Name of the signal in the configuration	
Pulse mode	Mode in which module signals are reset to 0 after processing received data	Only for “VInput” module

5.3.1.2.4 Time synchronization module (figure 142)

Module B1281 provides time synchronization of the IED according to the IRIG-B standard.

General parameters	
Parameter	Value
Name	E1.1
Library block	B1281 (Clock sync module)
Cassete	A1
The address of block on the bus	21

Figure 142 – Time synchronization module

Simultaneous use of IRIG-B hardware synchronization (figure 143) and PPS is not allowed, therefore, if using IRIG-B synchronization, PPS hardware synchronization should be disabled.

Hardware synchronization (IRIG-B)

Hardware synchronization enabled

Standart IRIG-B ▾

Modification B007 ▾

Sync Source IRIG-B electrical ▾

Figure 143 – Hardware synchronization (IRIG-B)

The description of parameters of the time synchronization module is given in table 82.

Table 82 – Description of parameters of the time synchronization module

Parameter	Description
Hardware synchronization enabled	Indicator of enabling hardware synchronization
Standard	Standard of time synchronization
Modification	Modification of the time synchronization standard
Synchronization source	Selection of a synchronization source

5.3.1.2.5 Analog input module (figure 144)

The analog input module is designed to receive electrical analog signals of currents and voltages.

General parameters	
Parameter	Value
Name	E14
Library block	D2976 (Analog input module)
Cassete	A1
The address of block on the bus	4

Figure 144 – General parameters of the analog input module

5.3.1.2.6 Transceiver module (figure 145)

The transceiver module provides communication between the IED and external devices via RS-485 interface.

Parameter	Value
Function	Tranciever
Signals count	32
Transferring method	Single frequency

Figure 145 – General parameters of the transceiver module

The description of parameters of the transceiver module is given in table 83.

Table 83 – Description of parameters of the transceiver module

Parameter	Description
Function	Function of the module: – Receiver; – Transmitter; – Transceiver
Signal count	Quantity of signals – 8; – 16; – 24; – 32; – 64
Transmission method	Method of signal transmission: – Single-frequency; – Double-frequency serial; – Double-frequency parallel

5.3.1.2.7 Sampled Values reception module (figure 146)

The Sampled Values reception module is designed to receive analog signals via IEC 61850-9-2 protocol.

Parameter	Value
Name	E16
Library block	D3033 (Sampled Values module)
Cassete	A1
The address of block on the bus	1

N° stream	svID	MAC-address	Data sets	Type
1	EKRAMU0001	010CCD040001	Current(lnn)+...	...



Figure 146 – General parameters of the Sampled Values reception module

The description of parameters of the Sampled Values reception module is given in table 84.

Table 84 – Description of parameters of the Sampled Values reception module

Parameter	Description
Stream No.	Serial number
svID	String identifier of instantaneous values

Parameter	Description
MAC address	Destination address
Data sets	Current and/or voltage data of ASDU
Type	Opening the Value type window

When you click the button with image  a new ASDU of the Sampled Values reception module is added. When you click the button with image  the selected ASDU is deleted.

When you click button “...” (figure 146, item 1) the **Value type** window appears (figure 147).

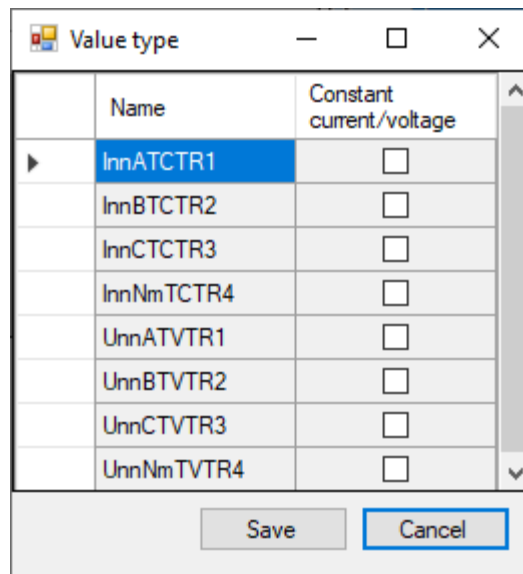

Figure 147 – **Value type** window

The description of parameters of the **Value type** window is given in table 85.

Table 85 – Description of parameters of the **Value type** window

Parameter	Description
Name	Name of the value type
Direct current/voltage	Value type (direct current or voltage)

5.3.1.2.8 Logic module (figure 148)

Logic module provides operation of IED software, external connection via Ethernet and RS-485 interfaces, connection of the IRIG-B time synchronization signal.

General parameters	
Parameter	Value
Name	E1
Library block	L2654 (Controller module)
Cassete	A1
The address of block on the bus	21

Figure 148 – General parameters of the logic module (logic module)

5.3.1.2.9 Power supply module (figure 149)

The power supply module provides all components of the device with a stabilized voltage, as well as protection of electronic elements from interference and overvoltage. It performs galvanic isolation of internal circuits of the device from the power circuit.

General parameters	
Parameter	Value
Name	E2
Library block	PU1602 (Power and control module)
Cassete	A1
The address of block on the bus	19

Figure 149 – General parameters of the power supply module

5.3.1.2.10 Binary output module (figure 150)

The binary output module contains output relays for generating control signals for external tripping and alarm circuits, the contacts of which are galvanically isolated from the internal circuits of the device.

Block signals			
Nº	Name	Return.DT, ms	Relay action
1	Relay 1	0	<input checked="" type="checkbox"/>
2	Relay 2	0	<input checked="" type="checkbox"/>
3	Relay 3	0	<input checked="" type="checkbox"/>
4	Relay 4	0	<input checked="" type="checkbox"/>
5	Relay 5	0	<input checked="" type="checkbox"/>
6	Relay 6	0	<input checked="" type="checkbox"/>
7	Relay 7	0	<input checked="" type="checkbox"/>
8	Relay 8	0	<input checked="" type="checkbox"/>
9	Relay 9	0	<input checked="" type="checkbox"/>
10	Relay 10	0	<input checked="" type="checkbox"/>
11	Relay 11	0	<input checked="" type="checkbox"/>
12	Relay 12	0	<input checked="" type="checkbox"/>
13	Relay 13	0	<input checked="" type="checkbox"/>
14	Relay 14	0	<input checked="" type="checkbox"/>
15	Relay 15	0	<input checked="" type="checkbox"/>
16	Relay 16	0	<input checked="" type="checkbox"/>

Figure 150 – Signals of binary output module

The description of parameters of output module signals is given in table 86.

Table 86 – Description of parameters of output module signals

Column	Description
No.	Number of the signal in the module
Name	Name of the signal in the configuration
Return DT, ms	Time delay for return in milliseconds
Relay action	Indicator of relay presence

5.3.1.2.11 Indication module (figure 151)

The indication module is designed for displaying, monitoring the current state, editing settings, checking operation of the device, making an external connection of the device to the computer.

The screenshot shows a window titled "Block signals" with tabs A, B, C, D, E, and F. Below the tabs is a table with two columns: "№" and "Name". The table contains 16 rows of signal data.

№	Name
1	Start disturb. recorder
2	Start rec. from keyboard
3	Warning signaling
4	Start
5	Diagnostics
6	Failure
7	Failure signaling
8	Control relay
9	Ready
10	In service
11	Out of service
12	Indication
13	Reset
14	Power on
15	Synchronization
16	LEDs diagnostics

Figure 151 – Signals of the indication module

The description of signal parameters of the indication module is given in table 87.

Table 87 – Description of signal parameters of the indication module

Column	Description
No.	Number of the signal in the module
Name	Name of the signal in the configuration
A, B, C, D...	LED columns

5.3.1.2.12 Binary input module (figure 152)

Block signals			
Nº	Name	Oper.DT, ms	Return.DT, ms
1	Input 9	15	6
2	Input 10	15	6
3	Input 11	15	6
4	Input 12	15	6
5	Input 13	15	6
6	Input 14	15	6
7	Input 15	15	6
8	Input 16	15	6
9	Input 17	15	6
10	Input 18	15	6
11	Input 19	15	6
12	Input 20	15	6
13	Input 21	15	6
14	Input 22	15	6
15	Input 23	15	6
16	Input 24	15	6

Figure 152 – Signals of binary input module

The description of parameters of binary input module signals is given in table 88.

Table 88 – Description of parameters of binary input module signals

Parameter	Description
No.	Number of the signal in the module
Name	Name of the signal in the configuration
Oper.DT, ms	Technological time delay for operate in milliseconds
Return DT, ms	Technological time delay for release in milliseconds

5.3.2 Analog inputs

Analog inputs are a combination of real signals (which are bound to the output of the sensor module), calculated signals (allows you creating signals from other signals using a certain function), virtual signals (allows you creating signals from other signals with different ratings and transformation ratios) and telemetry signals.

The **Analog inputs** window, device tree menu **Hardware part** → **Analog inputs**, are used as input data in the measuring element operation logic and in the formulas of the **Calculated values** tree node.

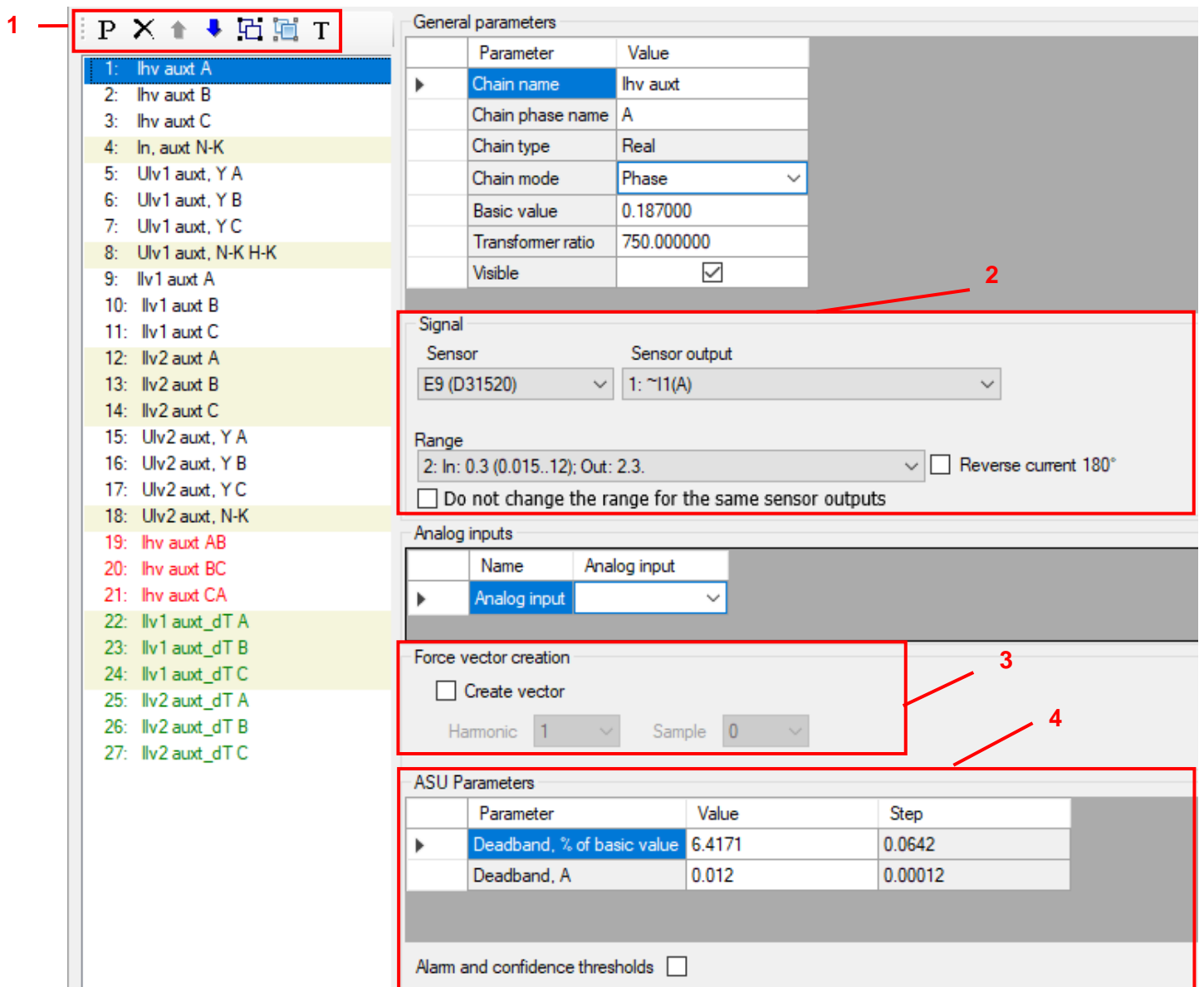

Figure 153 – Analog inputs window

Commands of analog input panel (figure 153, item 1) are shown in table 89.

Table 89 – Commands of analog input panel

Icon	Command
	Move up
	Move down
	Frequency groups...
	Grouping of analog inputs
	Create a telemetry signals

General parameters of analog signals are shown in table 90.

Table 90 – General parameters

Parameter	Description
Signal name	Name of the signal
Signal phase name	Name of the signal phase
Signal type	Signal type (real)
Signal mode	Mode (type) of signal (phase, linear, null, undefined)
Base value	Base value of the input signal of the sensor module input (without measurement unit)
Transformation ratio	Ratio of the nominal value of the signal in the primary circuit to the rated value of the signal at the sensor input (for example, when connecting a signal from the current transformer or voltage transformer)
Visible	The set flag allows displaying measurements in the Analog inputs item on the device display

Signal setting (figure 153, item 2)

The section is designed for binding the real signals to the physical output of the sensor module. The description of parameters of the signal section is given in table 91.

Table 91 – Parameters of the **Signal setting** section

Parameter	Description
Sensor	Sensor module from the general list
Sensor output	Sensor output of the selected sensor module
Range	Selecting the sensor output range
Reverse current 180°	The set flag turns the current by 180 degrees
Do not change the range for the same sensor outputs	The set flag forbids to change change the range for the same sensor outputs

Forced phasor creation (figure 153, item 3)

Forced creation of a phasor is necessary to set the option of using the analog input value in the IED if it is not used in any of the measuring elements. If the analog input is used in any measuring element, then the phasor will be created inside the measuring element and this parameter does not need to be set.

If no phasor is created for the analog input, the value of the analog input will not be displayed on the IED or in the Smart Monitor program.

The description of parameters of forced phasor creation is given in table 92.

Table 92 – Forced phasor creation

Parameter	Description
Create phasor	Selecting the option of phasor creation
Harmonic	Selecting a signal harmonic (selection of a harmonic for display)
Sample	Number of the sample on which the signal phasor is created (used to allocate processor time when calculating phasors)

Parameters of signal transmission to PCS (figure 153, item 4)

The section is designed for setting parameters of IEC 61850-8-1 and IEC 60870-5-104 protocols: values of analog data transmission and attributes of analog signal range.

The description of deadband parameters is given in table 93.

Table 93 – Parameters of signal transmission to PCS

Parameter	Description
Deadband, % of base value	Value that determines the limit of signal change, above which a report on the change in the signal value will be sent. Value in relative units, 1 relative unit equals to 0.00001 of the maximum value of the sensor input range.
Deadband, A	Value in absolute units. The value is calculated automatically by the program. It is equal to the product of the parameter in absolute units by the maximum value of the sensor input and 0.00001

The description of settings of the analog signal range is given in table 94.

Table 94 – Alarm and validity thresholds

Parameter	Description
Maximum	If the analog value is greater than the setting, the range value becomes high-high and the quality – questionable
Uppermost	If the analog value is greater than the setting, the range value becomes high-high and the quality – good
Upper	If the analog value is greater than the setting, the range value becomes high and the quality – good
Lower	If the analog value is greater than the setting, the range value becomes normal and the quality – good
Lowermost	If the analog value is greater than the setting, the range value becomes low and the quality – good
Minimum	If the analog value is less than the setting, the range value becomes low-low and the quality – questionable

5.3.2.1 Frequency groups

To operate the relay protection and automation functions in an extended frequency range (from 3 to 95 Hz), the digital signal processing algorithms must be adapted to the current network frequency. In the ED2 series devices, this adaptation is achieved by combining signals into frequency groups.

5.3.2.1.1 General

The configuration program is provided with the option to use a signal from one analog input of the IED in several frequency groups.

Frequency signal group is a variety of currents and voltages generated by the same source of electric power and used in the IED as a group of signals of the same frequency.

In the software configuration of IEDs, up to six frequency groups can be created numerated starting with zero.

Zero frequency group of signals is created automatically. Adaptation of signal processing algorithms of the zero frequency group to the current network frequency is not performed. Therefore, signals of the zero frequency group are intended for use in measuring elements (ME) operating in the frequency range from 45 to 55 (from 54 to 66) Hz.

To operate the ME in an extended frequency range (from 3 to 95 Hz), it is necessary to supply the signals included in a non-zero frequency group.



NOTICE

All signals fed to the measuring element must be in the same frequency group.
The exception is measuring element SC, SC (L), SC (BC), AS, RE < (VD) and RE < 17!

The frequencies of all signals of a non-zero frequency group are estimated based on the base signals of the frequency group. Base signals are selected when creating the software configuration of the IED in the frequency group editor.

The disadvantage of this method is that the frequency is calculated relative to the basic signal (current or voltage) and in the absence of this signal at the input, it will be impossible to correctly calculate the frequency. Therefore, the use of three base signals increases the reliability of the relay protection functions, since the frequency estimate remains available as long as at least one signal is present. To use three base signals, all three signals must be in the same three-phase group of signals.

5.3.2.1.2 Order of combining signals

To combine signals into frequency groups, it is required to:

- select frequency domains on the network diagram – network sections, the frequencies of currents and voltages for which are always equal;
- combine the signals used in the relay protection functions of the elements of each frequency domain into a separate non-zero frequency group.

To use three signals, the first signal of the three-phase group is marked in the editor of frequency groups (for example, voltage of phase A of the three-phase voltage group, figure 154).

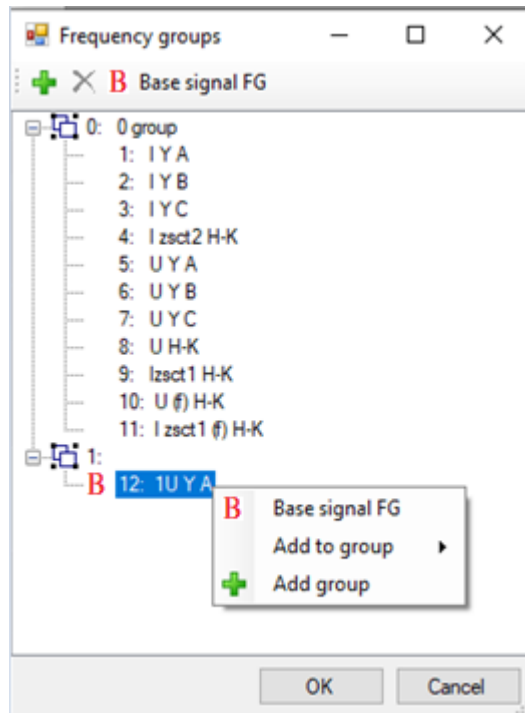

Figure 154 – **Frequency groups** window

5.3.2.1.3 Recommendations on selection of base signals of frequency groups

The reliability of RPA functions operating in the extended frequency range is determined by the possibility of estimating the frequency of base signals. Therefore, the signals that are present in all non-emergency modes of operation of the power facility (with changes in the diagram, mode, etc.) should be selected as base signals of the frequency group.

It is recommended to use phase or line voltages as base signals, since their level practically does not change with changes in diagrams and modes.

It is recommended to use three base signals.

If three phase voltages are used as base signals, then when creating a configuration, in order to increase reliability, it is recommended to activate the function of determining the frequency based on calculated line signals (figure 155).

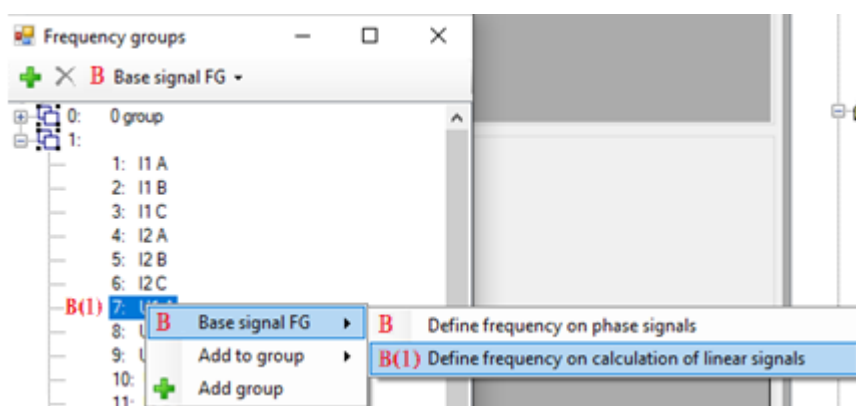

Figure 155 – Activating the function of estimating the frequency determination based on calculated line signals

5.3.2.1.4 Example

It is required to distribute signals measured in the power circuit to frequency groups and to select base signals (figure 156).

In the diagram under consideration, two frequency regions can be distinguished:

- generator-transformer unit;
- excitation circuits – earth.

Measuring transducers CT1, CT2, CT3 and VT1 are used to protect the generator and transformer, and CT4 and VT2 are used to protect the excitation winding. Therefore, in the diagram under consideration, signals must be combined into frequency groups according to table 95.

In frequency domain No. 1, a three-phase group of voltages from VT1 is selected as the basic signal. In frequency domain No. 2, the voltage from VT2 is selected as the basic signal.

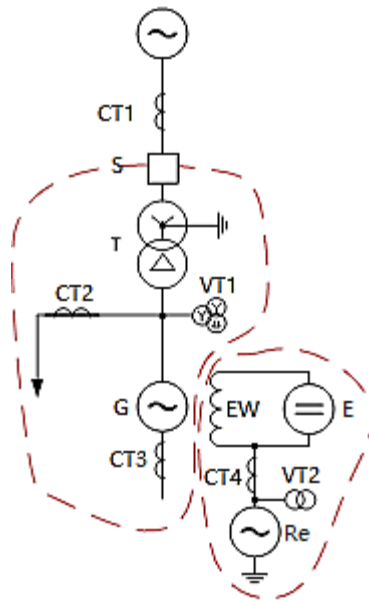



Figure 156 – Diagram

Table 95 – Frequency groups

Frequency group No.	Sources of signals included in frequency group	Source of basic signal of frequency group
1	CT1, CT2, CT3, VT1	VT1
2	CT4, VT2	VT2

5.3.2.2 Grouping analog inputs

The function is required for grouping analog inputs. It is used in cases where ungrouped circuits are grouped to bind them to measuring elements. When you click on the **Grouping analog inputs** button  , located on the toolbar, an editor (figure 157), is displayed in which you can group ungrouped analog inputs. In this window, you can add, remove groups of analog inputs using the buttons on the toolbar of the window.

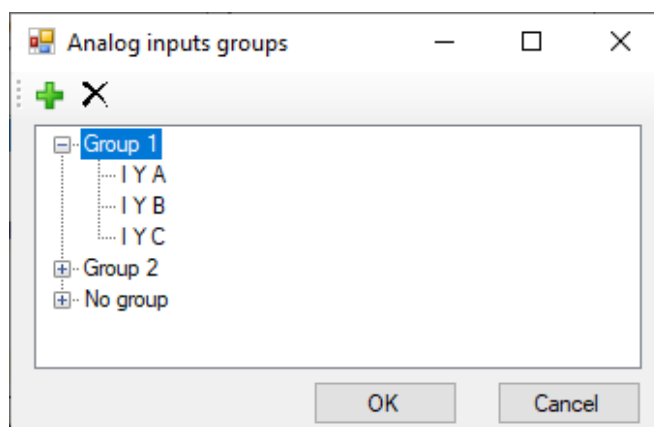

Figure 157 – **Groups of analog inputs** window

5.3.3 Binary inputs

The **Binary inputs** window, device tree menu **Hardware part** → **Binary inputs** (figure 158), is designed for configuring binary inputs of the device (circuits of binary input and virtual input modules).

Technological binary input time delays (designed for offset from interference):

- for operate;
- for return.

Note – Changing time delays in binary inputs or input modules in the **Modules** menu item is synchronized.

Allows you to set the total value of time delays for operate and return for all inputs (figure 158, item 1).

Enable inverting (figure 158, item 2): All inputs – when the box is checked, binary inputs of all modules are enabled for inverting.

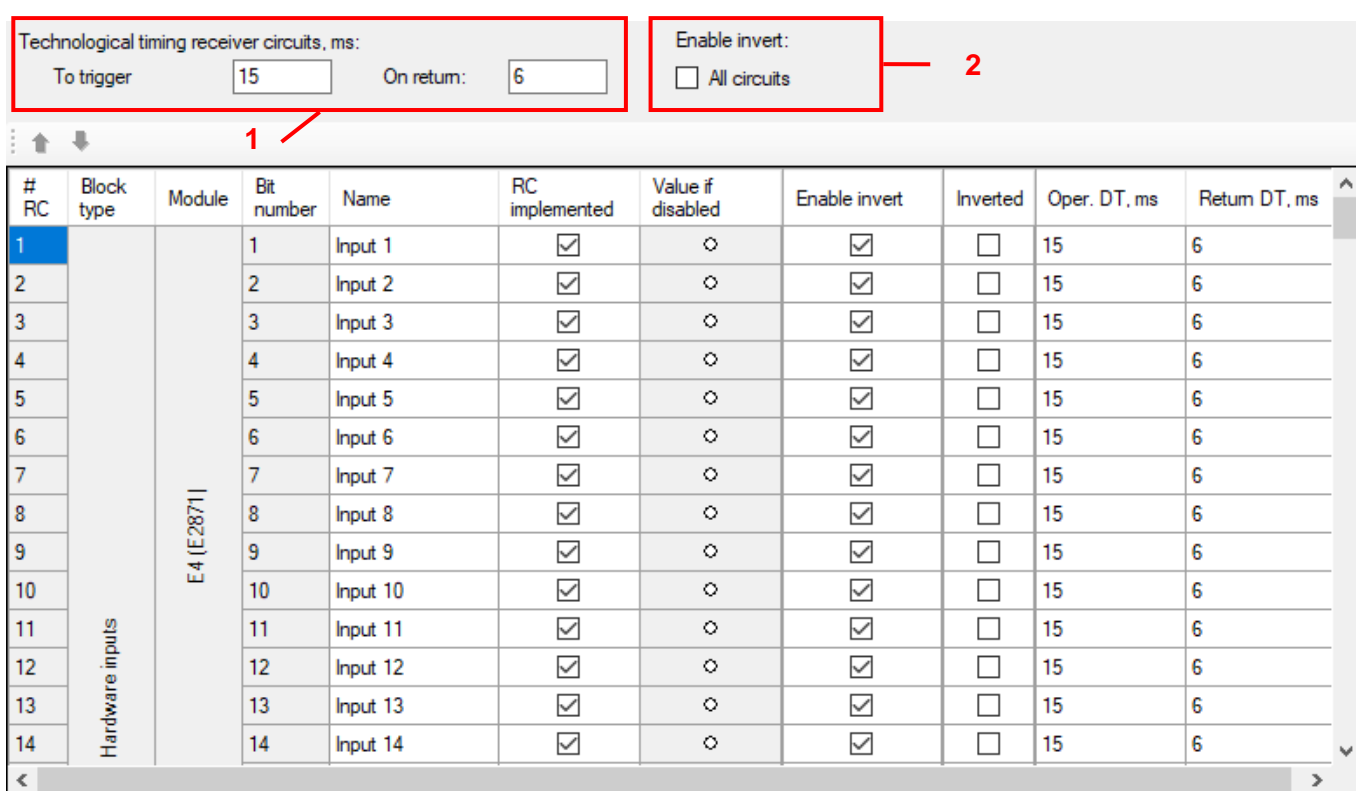

Figure 158 – **Binary inputs** window

Parameters of inputs are shown in table 96.

Table 96 – Parameters of binary input

Parameter	Description
BI No.	Number of the binary input in the list of binary input
Module type	Name of belonging of the binary input module
Module	Name of the module of binary inputs
Bit No.	Sequence number of the binary input on the device board
Name	Name of the binary input in the configuration
BI enabled	Indicator of processing the binary input by the device
Value when disabled	Binary input value when it is disabled

Parameter	Description
Invert	Checked box indicates inversion of module's binary input
Oper.DT, ms	Operate time in milliseconds (only for physical binary input modules)
Return DT, ms	Return time in milliseconds (only for physical binary input modules)

5.3.4 System parameters

5.3.4.1 Communication parameters

The tab is designed for configuring communication parameters of the IED.

5.3.4.1.1 Interfaces

The checked box allows you writing settings when connected to the terminal via the selected interface (figure 159).

	Number	Name	Service functions
▶	1	RS-485-1	<input type="checkbox"/>
	2	RS-485-2	<input type="checkbox"/>
	3	Ethemet 1	<input type="checkbox"/>
	4	Ethemet 0 (service port)	<input checked="" type="checkbox"/>
	5	Ethemet 2	<input type="checkbox"/>

Figure 159 – Interfaces



NOTICE

In order to increase the level of information security and prevent unauthorized access to the device, it is recommended to assign service functions to the Ethernet 0 port, which is located on the front panel of the device.

5.3.4.1.2 TCP/IP parameters

Setting the parameters for checking the connection and parameters for TCP requests (figure 160).

Ethemet network		Parameters TCP request	
Connection aviability check params (TCP KeepAlive)			
Check period, s	15	The maximum time between TCP request and response, ms	60000
Packet send delay, s	3	The minimum time between TCP request and response, ms	6000
Packets sending time, s	15	Retransmission time of the TCP requests, ms	180000

Figure 160 – TCP/IP parameters

Parameters of TCP/IP are shown in table 97.

Table 97 – Parameters of TCP/IP

Parameter	Description
Connection check parameters (KeepAlive)	<ul style="list-style-type: none"> – Check period (idle time of the line, after which the connection check will start) in seconds; – Packet send interval (time between sending service packets) in seconds; – Packet send time (time for sending service packets) in seconds
Parameters of TCP requests	<ul style="list-style-type: none"> – Maximum time between TCP request and response in milliseconds; – Minimum time between TCP request and response in milliseconds; – Time of repeated TCP requests in milliseconds

5.3.4.1.3 Network interface settings

IP addresses are configured for communication interfaces such as Ethernet (figure 161).

- Network interfaces settings

	Interface	Address	Mask	Gateway
▶	Ethernet 1	192.168.33.1	255.255.255.0	192.168.33.237
	Ethernet 0 (service port)	192.168.200.200	255.255.255.0	192.168.200.237
	Ethernet 2	192.168.33.1	255.255.255.0	192.168.33.237

Figure 161 – Network interface settings

Note – Each port must have its own subnet, except for ports that are reserved for each other.

5.3.4.1.4 Serial ports

Communication settings for all serial ports (figure 162). The **Protocol** parameter specifies the selected communication protocol for the operation of the serial port. For the USB port, the settings are fixed and cannot be changed. The **IED address** parameter allows you to select an IED address for each serial port.

Serial ports

	Port name	Port speed	Data bits	Parity	Stop bits	Symbols delay	Protocol	Terminal address
▶	RS-485-1	115200	8	None	1	0	ModbusRTU	1
	RS-485-2	115200	8	None	1	0	ModbusRTU	1
	USB	921600	8	None	1	0	ModbusRTU	1

Figure 162 – Serial port

5.3.4.2 Time synchronization

The tab is designed for configuring parameters of software and hardware time synchronization.

5.3.4.2.1 Software time synchronization (figure 163)

Figure 163 – Software time synchronization

Parameters of software time synchronization are shown in table 98.

Table 98 – Software time synchronization

Parameter	Description
Interface	Selection of interface for software time synchronization
Protocol	Protocol for the selected interface
Correction (in hours)	Correction of time synchronization in hours
Adjust for daylight saving time automatically	Checked box indicates automatic switch to summer/winter time

5.3.4.2.2 Hardware synchronization (PPS) (figure 164)

Figure 164 – Hardware synchronization (PPS)

Parameters of PPS hardware synchronization are shown in table 99.

Table 99 – Hardware synchronization (PPS)

Parameter	Description
Hardware sync enabled	Enable use of hardware synchronization
Synchropulse period, s	Selection of synchronization pulse period in seconds
Registered transition	Selection of transition to fall or rise (parameter determines when time synchronization occurs)
Minimum pulse duration, ms	Selection of the minimum pulse duration in milliseconds (for protection from interference and chatter)
Calibration value, ms	Selection of the calibration value in milliseconds
Permissible deviation of synchro-pulse period, ms	Selection of permissible deviation of the synchropulse period in milliseconds
Synchronization source	Time synchronization source

Note – Hardware synchronization must be disabled if IRIG-B time synchronization is enabled in the configuration.

5.3.4.3 Hardware synchronization (IRIG-B) (figure 165)

Hardware synchronization (IRIG-B)

Hardware synchronization enabled

Standart: IRIG-B

Modification: B007

Sync Source:

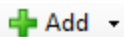

Figure 165 – Hardware synchronization (IRIG-B)

Parameters of IRIG-B hardware synchronization are shown in table 100.

Table 100 – Parameters of IRIG hardware synchronization

Parameter	Description
Hardware sync enabled	Enable use of hardware synchronization
Standard	Time synchronization standard
Modification	Version of the time synchronization standard
Synchronization source	Time synchronization source

5.3.4.4 Ethernet protocols

The tab is designed for configuring protocols. Adding and deleting protocols is carried out using buttons  and  (figure 166, item 1).

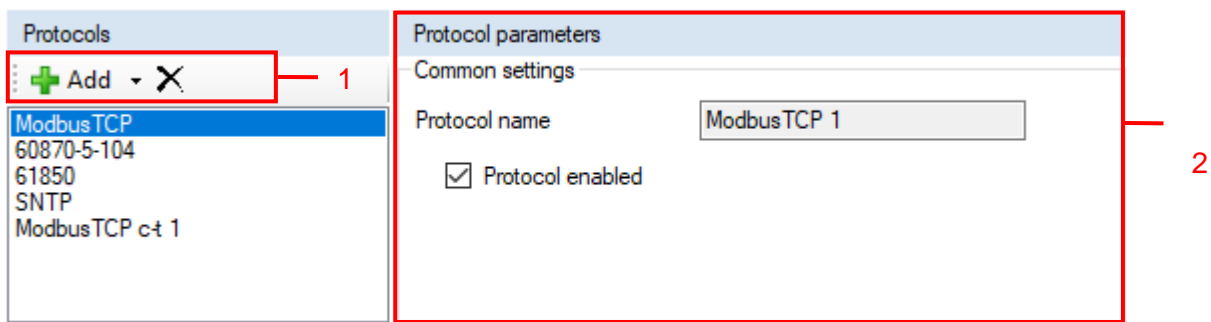

Figure 166 – Ethernet protocols tab

Note – The composition of protocols may differ depending on the type of device.

General parameters of protocols are shown in table 101.

Table 101 – General parameters of protocols

Parameter	Description
Protocol name	ModbusTCP, 60870-5-104, 61850, SNTP, ModbusTCP c-t, PTP
Protocol enabled	Indicator of enabling protocol operation in IED software

5.3.4.4.1 Configuring the ModbusTCP data transmission protocol (figure 166, item 2)

5.3.4.4.2 Configuring the 60870-5-104 (IEC 60870-5-104) data transmission protocol (figure 167)

Protocol parameters

Common settings

Protocol name

Protocol enabled

Other settings

Setting	Value
▶ Clients number	3
Transmit type	Periodic & Sporadic ▾
Client timeout (sec)	60
Measurand data type	Float ▾
Measurand cycle (sec)	300
Binary data	Logic values
Analog data	Analog values
Logic values base address	257
Binary outputs base address	1281
Analog values base address	2561
Calc. values base address	3073
Protect vectors base address	3329
Transfer mode	Balanced ▾
ASDU address size	2
Cause of transmission size	2
Info object address size	3
k Max APDUs without ACK	12
w Latest ACK after recv. w APDUs	8
Address ASDU	1

Figure 167 – Parameters of the IEC 60870-5-104 protocol

The description of parameters of the IEC 60870-5-104 protocol is shown in table 102.

Table 102 – Parameters of the IEC 60870-5-104 protocol

Parameter	Description
Quantity of clients	Maximum possible quantity of clients that can be connected to the IED using the IEC 60870-5-104 protocol (default – 3, maximum – 10)
Measurement transmission type	<ul style="list-style-type: none"> – Cyclic (periodic) – 0; – Sporadic (when signal is changed) – 1; – Cyclic & Sporadic – 2 (by default); – Disabled – 3
Client time-out, s	Time interval in seconds, after which it is considered that there is no connection with a client if no data was received from the client (60 by default)
Measurement data type	<ul style="list-style-type: none"> – Normalized – 1; – Scalable – 2; – Floating point – 3 (by default)
Sending period, s	Time interval in seconds during which the transmission of cyclic measurements is repeated

Parameter	Description
Binary data	Composition of transmitted binary data: – Logic signals – 1; – Binary outputs – 2; – All signals – 3
Analog data	Composition of transmitted analog data: – Analog values – 1; – Calculated values – 2; – Protection phasors – 3; – All measurements – 4
Base address of logic signals	Base address of logic signals (value must be in the range of 1 to 16,777,215) according to IEC-60870-5-104 protocol. It is not recommended to change the value without agreement with software developers of the ED2 series device. Default value 257
Base address of binary outputs	Base address of binary outputs (value must be in the range of 1 to 16,777,215) according to IEC-60870-5-104 protocol. It is not recommended to change the value without agreement with software developers of the ED2 series device. Default value 1281
Base address of analog values	Base address of analog values (value must be in the range of 1 to 16,777,215) according to IEC-60870-5-104 protocol. It is not recommended to change the value without agreement with software developers of the ED2 series device. Default value 2561
Basic address of calculated values	Base address of calculated values (value must be in the range of 1 to 16,777,215) according to IEC-60870-5-104 protocol. It is not recommended to change the value without agreement with software developers of the ED2 series device. Default value 3073
Base address of protection phasors	Base address of protection phasors (value must be in the range of 1 to 16,777,215) according to IEC-60870-5-104 protocol. It is not recommended to change the value without agreement with software developers of the ED2 series device. Default value 3329
Transmission mode	Protocol operation mode Constant parameter By default – Balanced
ASDU address size	Constant parameter By default – 2
Size of transmission reason field	Constant parameter By default – 2
Size of information object address	Constant parameter By default – 3
k Max. quantity of APDU without ACK	Value of k indicates the maximum quantity of consecutively numbered Format I APDUs that can be transmitted without acknowledgment (value must be in the range of 1 to 32,767 in increments of 1). Default value 12
w Sending an ACK after receiving w APDU	Value of w is the quantity of APDUs read, after which an ACK should be sent (value must be in the range from 1 to 32,767 in increments of 1). Default value 8
ASDU address	By default – 1 ((value must be in the range of 1 to 247)

The list of transmitted signals via IEC 60870-5-104 protocol is shown in table 103. It can be generated via main menu **Service** → **Reports** → **IEC 60870-5-104 protocol data**.

Table 103 – List of signals transmitted via IEC 60870-5-104 protocol

Signal	Transmission method
Binary signals	These signals are transmitted via ASDU 30 (IEC 60870-5-101). The size of the address field of the information object is 3 bytes. The signal value is represented by the SPI bit of the SIQ field of size 1 byte (IEC 60870-5-101)

Signal	Transmission method
Analog measurements	Measurement data is transmitted via ASDU 13 (IEC 60870-5-101). Size of the address field of the information object is 3 bytes. The measurement value is represented by a short floating point format of 4 bytes (IEC 60870-5-101)
Commands	These signals are transmitted via ASDU 45 and ASDU 46 (IEC 60870-5-101)
Analog channels	These signals are transmitted via ASDU F_SG_NA_1 (IEC 60870-5-101)

5.3.4.4.3 Configuring the IEC 61850 (IEC 61850-8-1) data transmission protocol (figure 168)

Protocol parameters	
Common settings	
Protocol name	61850 1
<input checked="" type="checkbox"/> Protocol enabled	
Other settings	
Setting	Value
GOOSE out enabled	<input checked="" type="checkbox"/>
GOOSE in enabled	<input checked="" type="checkbox"/>
IED name	ID2
Is extended	<input type="checkbox"/>
Comtrade file names code page	Windows-1251

Figure 168 – Parameters of the IEC 61850 protocol

Description of parameters of the IEC 61850 protocol is shown in table 104.

Table 104 – Description of parameters of the IEC 61850 protocol

Parameter	Description
Enable outgoing GOOSE	It is permitted to exchange binary data between IEDs via GOOSE messages. Data transmission is planned for this device
Enable incoming GOOSE	It is permitted to exchange binary data between IEDs via GOOSE messages. Data reception is planned for this device
IED name	Device name (identifier) available only via IEC 61850-8-1 protocol
Sign of using an extended protocol	If the documented option of IEC 61850-8-1 to add its data types and attributes (protocol extension) is used
Encoding of COMTRADE file names	Encoding used for COMTRADE file names (Windows-1251 or UTF-8)

When adding the IEC 61850 (IEC 61850-8-1) protocol to the configuration, the **IEC61850** menu item will appear in the project tree.

5.3.4.4.4 Configuring the SNTP time synchronization protocol

Quantity of servers used for time synchronization via SNTP protocol is no more than four.

The SNTP protocol is described in the Configurator with the following parameters (figure 169):

- Enabled;
- Priority (Very low, Low, High, Very high);
- Server IP address;
- Server port;
- Synchronization period, s;
- Response wait time, s.

Protocol parameters

Common settings

Protocol name

Protocol enabled

Choose of server

Other settings

	Setting	Value
▶	Server #1	
	Activated	<input checked="" type="checkbox"/>
	Priority	Very Low ▾
	Server IP	192.168.33.100
	Server port	123
	Synchronizing period, s	64
	Answer wait time, s	2
	Server #2	
	Activated	<input checked="" type="checkbox"/>
	Priority	Very Low ▾
	Server IP	182.168.255.251
	Server port	123
	Synchronizing period, s	64
	Answer wait time, s	2
	Server #3	
	Activated	<input checked="" type="checkbox"/>
	Priority	Very Low ▾
	Server IP	128.0.0.1
	Server port	123
	Synchronizing period, s	64
	Answer wait time, s	2
	Server #4	
	Activated	<input checked="" type="checkbox"/>
	Priority	Very Low ▾
	Server IP	127.0.0.1
	Server port	123
	Synchronizing period, s	64
	Answer wait time, s	2

Figure 169 – Parameters of the SNTP protocol

5.3.4.4.5 Configuring the ModbusTCP c-t data transmission protocol (Modbus TCP client) (figure 170)

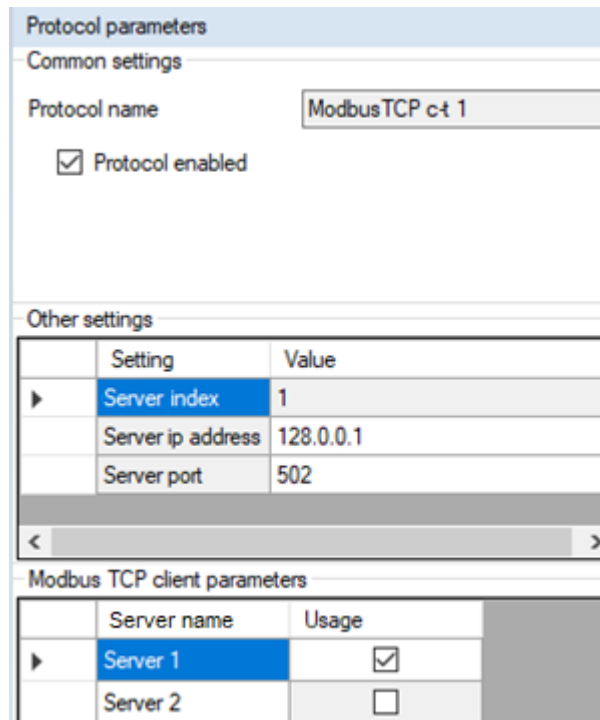

Figure 170 – Parameters of the ModbusRTU c-t protocol

The description of parameters is shown in table 105.

Table 105 – Description of additional parameters of the Modbus TCP client protocol

Parameter	Description
Additional parameters	
Server index	Client number from "ModbusClients" (1 by default). The parameter is not directly editable. The value is set by selecting one of the values in the "Modbus TCP client parameters" table
Server IP address	IP address of the server to which the client is connecting (128.0.0.1 by default)
Server port	TCP port of the server to which the client is connecting (502 by default)
Modbus TCP client parameters Параметры клиента Modbus TCP	
Server name	The name of the server to which the client is connecting. Configured in the ModbusClients tab
Usage	Selecting the appropriate server for a given client

5.3.5 Configuring the PTP data transmission protocol (figure 171)

Protocol parameters

Common settings

Protocol name

Protocol enabled

Other settings

	Setting	Value
▶	Synchronizing period (sec)	60
	Clock type	Boundary ▼
	Management via PTP	<input type="checkbox"/>
	Sync lower bound (1..999999999 nanoseconds)	30
	Sync upper bound (1..999999999 nanoseconds)	5000
	(Boundary) domain 0..255	0
	(Boundary) priority1 0..255	128
	(Boundary) priority2 0..255	128
	(Boundary) utc offset -32768..32768 seconds	0
	(Boundary) utc offset is valid	<input type="checkbox"/>
	(Transparent) delay mechanism	e2e ▼
	(Transparent) is multi domain	<input type="checkbox"/>
	(Transparent) network protocol	ieee802.3 ▼
	(Transparent) primary domain 0..255	0
	(Transparent) is sync local clock	<input checked="" type="checkbox"/>
	(Transparent) vlan	none ▼
	(Transparent) vlan-priority 1..7	4

Figure 171 – Parameters of the PTP data transmission protocol

The description of parameters of the PTP data transmission protocol is given in table 106.

Table 106 – Parameters of the PTP data transmission protocol

Parameter	Description
Synchronization period, s	Time interval in seconds (value must be in the range of 2 to 3,600 s) by the expiration of which synchronization is repeated
Clock type	It sets the synchronization algorithm: <ul style="list-style-type: none"> – Boundary; – Transparent
Management via PTP	Enable/disable PTP control
Sync lower bound (1..999,999,999 nanoseconds)	Minimum time difference between local clock and source of reference time in nanoseconds (value must be in the range of 1 to 999,999 999 ns)
Sync upper bound (1..999,999,999 nanoseconds)	Maximum time difference between local clock and source of reference time in nanoseconds (value must be in the range of 1 to 999,999 999 ns)
(Boundary) domain 0..255	Binding of the device to a specific PTP domain (value must be in the range of 0 to 255)
(Boundary) priority 1 0..255	It determines the priority for port 1 (value must be in the range of 0 to 255)
(Boundary) priority 2 0..255	It determines the priority for port 2 (value must be in the range of 0 to 255)

Parameter	Description
(Boundary) utc offset -32,768..32,768	Difference between PTP and UTC timeline in seconds (value must be in the range of minus 32,768 and plus 32,767 s)
(Boundary) utc offset is valid	Offset from timeline: – box checked – timeline offset; – box not checked – no timeline offset
(Transparent) delay mechanism	Algorithm for measuring the delay of the transmitted messages: – e2e; – p2p; – e2e-optimized; – none
(Transparent) is multi domain	Operation of the PTP synchronization independent of the domain: – box checked – operation of PTP synchronization enabled; – box not checked – operation of PTP synchronization disabled
(Transparent) network protocol	Network protocol, through which synchronization messages are transmitted: – ieee802.3; – udp-ipv4
(Transparent) primary domain 0...255	Binding of the device to a PTP domain (value must be in the range of 0 to 255)
(Transparent) is sync local clock	Synchronization of the local clock: – box checked – local clock synchronized; – box not checked – local clock not synchronized
(Transparent) vlan	Operation of PTP in a specified virtual network (VLAN ID), number of the virtual network: – none; – 0; – 1
(Transparent) vlan-priority 1...7	Priority with which the device transmits messages of the PTP synchronization related to this VLAN ID (value must be in the range of 1 to 7)

5.3.5.1 Serial protocols

The tab is designed to configure communication protocols which are available for operation via serial communication ports (COM):

- ModbusRTU;
- 60870-5-103 (IEC 60870-5-103);
- ModbusRTU c-t (Modbus RTU client);
- IEC 103Master (IEC 60870-5-103Master);
- Transparent port.

All serial protocols have a uniform parameter – protocol name (figure 172).

The image shows a software interface for configuring protocol parameters. At the top, there is a header 'Protocol parameters' in a light blue bar. Below it, the 'Common parameters' section is expanded, showing a 'Protocol name' label and a text input field containing the text 'ModbusRTU'.

Figure 172 – Parameters of the protocol

Note – The ModbusRTU protocol has no additional parameters.

5.3.5.1.1 Additional parameters of the IEC 60870-5-103 protocol (figure 173)

Protocol parameters	
Common parameters	
Protocol name	60870-5-103
Additional parameters	
Parameter	Value
▶ Transmit type	Periodic & Sporadic
Delay analogs (sec)	300
Measurand data type	Float(asdu 4)
Analog data	Analog values
Binary data	Logic values, Binary outputs
Logic values base address	256
Binary outputs base address	1280
Analog values base address	2560
Calc. values base address	3072
Skip INF zeros	<input type="checkbox"/>

Figure 173 – Parameters of the IEC 60870-5-103 protocol

The description of parameters of the IEC 60870-5-103 protocol is given in table 107.

Table 107 – Description of parameters of the IEC 60870-5-103 protocol

Parameter	Description
Measurement transmission type	It sets the type of measurement transmission: <ul style="list-style-type: none"> – Cyclic; – Sporadic; – Cyclic & Sporadic; – Disabled (no transmission)
Measurement transmission period, s	Time setting the delay in seconds when transmitting measurements
Measurement data type	With floating point (asdu 4), with fixed point (asdu 9)
Analog data	Set of transmitted measurements which consists of the following groups: analog measurements, calculated measurements, protection phasors
Binary data	Set of transmitted binary measurement groups which consists of the following groups: logic signals and binary outputs
Base address of logic signals	Decimal value, which sets the base address of logic signals
Base address of binary outputs	Decimal value, which sets the base address of binary outputs
Base address of analog values	Decimal value, which sets the base address of analog values
Basic address of calculated values	Decimal value, which sets the base address of calculated values
Omit zeros in INF field	Omission of zeros in the information field. When the value of the address parameter for the IEC 60870-5-103 protocol is set, fieldless INF = 0 is generated

5.3.5.1.2 Parameters of the ModbusTCP Master protocol

In the **Modbus RTU Master parameters** group (figure 174) used Modbus clients are set, which are added in the **Modbus Client** tab (item 5.6).

Protocol parameters	
Common parameters	
Protocol name	ModbusRTU ct 1
Modbus RTU client parameters	
Server name	Using
Server 1	<input type="checkbox"/>
Server 2	<input checked="" type="checkbox"/>

Figure 174 – Parameters of the ModbusRTU Master protocol

5.3.5.1.3 Parameters of the IEC60870-5-103 Master protocol (figure 175)

Protocol parameters	
Common parameters	
Protocol name	IEC103Master
Additional parameters	
Parameter	Value
Slaves set	

Figure 175 – Parameters of the IEC 103Master protocol

The description of parameters of the IEC 103Master protocol is given in table 108.

Table 108 – Description of parameters of the IEC 103Master protocol

Parameter	Description
Set of slave devices	Polled slave device is selected, which is added in the 103 protocol master tab (item 5.9)

5.3.5.1.4 Parameters of the Transparent port protocol (рисунок 176)

The description of parameters of the Transparent port protocol is given in table 109.

The screenshot shows a configuration window titled 'Protocol parameters'. It is divided into two sections: 'Common parameters' and 'Additional parameters'. In the 'Common parameters' section, the 'Protocol name' field contains the text 'Transparent port'. The 'Additional parameters' section is a table with two columns: 'Parameter' and 'Value'. The first row in the table has 'Tcp port' in the 'Parameter' column and '49100' in the 'Value' column. The table has a scroll bar at the bottom.

Figure 176 – Parameters of the Transparent port protocol

Table 109 – Description of parameters of the Transparent port protocol

Parameter	Description
Tcp port	Base port of TCP protocol for connection client's applications.

5.3.5.2 Setting groups

The tab is designed for configuring the switching of setting groups.

For fast switching of the settings required for the protected facility, setting groups are implemented in one configuration file.

In each group one can specify individual settings for measuring elements, logic elements, tripping matrix and calculated values. All other parameters (hardware settings, PCS, etc.) are the same for all setting groups. It is possible to switch the group of settings by changing the electronic switches and logic signals in the “local” and “remote” control modes. It is possible to assign a binary input of cabinet for each setting group for activation, in case of its operation a setting group with the index of this group number is applied automatically.

By default, the name of the setting group should be: “Setting group X”, where X is the sequence number of the setting group. The maximum length of the setting group name must not exceed 23 characters.

Values from one setting group to another are copied by pressing the **Copy** button (figure 177). Pressing this button copies the selected settings from the From group to the To group. After the copying is completed, an information window appears about the successful completion of the operation.

One can select settings in the Measuring elements, Logic elements, Calculated values, Tripping matrix groups.

When the box is checked in field **Common tripping matrices for all setting groups**, all setting groups have a common tripping matrix.

When the box is checked in field **Password request when switching setting group via el. switch**, the switching of settings is accompanied by a password request.

Communication parameters | Synchronization | Ethernet protocols | Serial protocols | **Settings groups** | IED parameters | Ethernet reserving settings | Diagnostic parameters | Control mode | Security parameters

Settings group count: 3

Default settings group: 1

Switch source settings: Logic signals decoder

N°	Settings group name	Signal 1	Signal 2
1	Setting group 1	<input type="checkbox"/>	<input type="checkbox"/>
2	Setting group 2	<input checked="" type="checkbox"/>	<input type="checkbox"/>
3	Setting group 3	<input type="checkbox"/>	<input checked="" type="checkbox"/>

Decoder signal1	Decoder signal2
417: Decoder signal1	418: Decoder signal2

Setting copying parameters

From: [dropdown] To: [dropdown]

Copy

- Protections
- Matrix of outages
- Calculated values settings
- Logic elements settings

Matrix of outages is common for all groups

Figure 177 – **Setting groups** window

Parameters of the **Setting groups** tab are shown in table 110.

Table 110 – Parameters of the **Setting groups** window

Parameter	Description
Quantity of setting groups	Quantity of setting groups (minimum – 2, maximum – 100, “none” – there is only one setting in the project)
Active setting group by default	Selection of an active setting group from the assigned quantity of setting groups
Setting group switching source	Switching sources – Electronic switch (when changing electronic switches on the indication module); – Logic signal (when the logic signal changes); – Logic signal decoder (when switching a setting group with a wafer switch)
No.	Number of the setting group
Setting group name	Name of the setting group
Activation signal	Signal of activation of the setting group

5.3.5.3 IED parameters

The figure 178 shows a form for setting device parameters.

The screenshot displays a configuration form for IED parameters, organized into several sections. Red boxes and lines with numbers 1 through 8 highlight specific elements:

- 1:** Test relay section, containing 'Block: E6' and 'Block chain: 6: Test' dropdown menus.
- 2:** Flash memory section, containing 'Type, MB: 1024' dropdown menu.
- 3:** Language section, containing 'Terminal language: Russian' dropdown menu.
- 4:** Display section, containing 'Time to sleep mode activation: 10 min.', 'Logout time: 10 min.', and 'Default menu item: "Main menu"' dropdown menu.
- 5:** Working frequency section, containing 'Frequency of DSP working cycle: 1200 Hz (24)', 'Oscillography frequency, Hz: 1200', 'Logic running frequency: default (on each samp)', and 'Base frequency, Hz: 50' dropdown menus.
- 6:** Delivery parameters section, containing 'Object name: Типовые шкафы' and 'Terminal functionality code: 6-35 kV RPA' dropdown menus.
- 7:** Correction processing time of digital inputs section, containing 'Time correction enabled' checkbox and two spinners for 'On switch to 1, ms' and 'On switch to 0, ms'.
- 8:** Display mode analog values section, containing 'Display Mode: Secondary' dropdown menu.

Figure 178 – IED parameters tab

Test relay (figure 178, item 1)

The ED2 series devices have a special test relay that is not controlled by enabling/disabling of the IED.

It sets the position of the test relay for automated testing using external programs (for example, using the Smart Monitor program).

In the drop down list select a relay module, after relay module selection, specify a required circuit.

Memory card (figure 178, item 2)

It sets the type of memory card that is installed inside the device, in megabytes. The allowed memory range is from 32 to 32,768 MB.

Language (figure 178, item 3)

This section sets the IED language (Russian or English or Spanish).

Display (figure 178, item 4)

This section sets the time until the IED display switches to the standby mode, the time until the password is reset, and the default menu item.

Operation frequency (figure 178, item 5)

The **Operation frequency** parameter specifies the operation frequency of IED's functional processor. Possible parameter values:

- 1,000 Hz;
- 1,200 Hz;
- 2,000 Hz.

The value of 1,000 Hz is set in case of using the Sample Value reception report block according to the IEC 61850-9-2LE protocol, as well as in control IEDs. The value 2,000 Hz is set for the functional purpose "Communication device". In all other cases, the value is set to 1,200 Hz.

Possible values for frequency of logic execution:

- default (on each sample);
- on odd sample.

For **Disturbance recording frequency, Hz**, 1,200 Hz and 2,400 Hz are available, for devices with a DSP operation cycle – 1,200 Hz, 1,000 Hz and 2,000 Hz, for a device with a DSP operation cycle – 1,000 Hz.

Supply parameters (figure 178, item 6)

In the **Object name** field, select the energy facility to which the IED will be supplied.

The **IED functionality code** field indicates the relation of the IED to the functions performed:

- Protection Int;
- Bay Controller Int.

Binary input process time compensation (figure 178, item 7)

In the **Enable time correction** field compensation of the processing time of binary inputs is enabled.

The **On switch to 1, ms** field specifies the time in milliseconds that will be compensated upon switching from logic 0 to 1.

The **On switch to 0, ms** field specifies the time in milliseconds that will be compensated upon switching from logic 1 to 0.

Analog value display mode (used only in IED) (figure 178, item 8)

Available modes of analog value display:

- Secondary;
- Primary.

5.3.6 Ethernet redundancy settings

Ethernet redundancy is configured in two ways:

- when adding a controller module with two Ethernet interfaces and in the absence of a network redundancy board (**Hirschmann**);
- by adding a controller module with a network redundancy board (**Hirschmann**).

5.3.6.1 Configuration of Ethernet redundancy (with a network redundancy board (Hirschmann))

Select the **System parameters** section in the project tree and go to the **Ethernet redundancy settings** tab.

Set the required Ethernet redundancy protocol – **Redundancy** parameter (figure 179).

Ethernet reserving unit settings:

Group	Parameter	Value
Network params	Address	192.168.1.1
	Mask	255.255.255.0
	Gateway	192.168.1.1
	Management VLAN	1
Redundancy	Network redundancy protocol	none
Interfaces	Port1 on	<input checked="" type="checkbox"/>
	Port2 on	<input type="checkbox"/>

Figure 179 – Ethernet redundancy settings tab

The description of general parameters for all redundancy protocols is given in table 111.

Table 111 – Description of general parameters for all redundancy protocols

Group	Parameter	Description
Network parameters	Address	IP address of the redundancy module
	Mask	Subnet mask of the redundancy module
	Gateway	Subnet gateway of the redundancy module
	Management VLAN	Virtual network, which provides access to redundancy module settings. It affects all protocols of remote access to the redundancy module. For correct operation, VLAN, when set to a value other than 0, will be registered in the VLAN table on external ports of the module

When selecting network redundancy options, the program sets the following default values:

- network redundancy none (absent) (figure 179);
- network redundancy PRP (figure 180);

- network redundancy RSTP (figure 181);
- network redundancy LinkBackup (figure 182);
- network redundancy mrp (figure 183);

Ethernet reserving unit settings:

Group	Parameter	Value
Network params	Address	192.168.1.1
	Mask	255.255.255.0
	Gateway	192.168.1.1
	Management VLAN	1
Redundancy	Network redundancy protocol	prp
Prp	Supervision evaluate	<input type="checkbox"/>
	Supervision redbox exclusively	<input type="checkbox"/>
	Supervision send	<input checked="" type="checkbox"/>

Figure 180 – Configuration of redundancy via PRP protocol

The description of redundancy settings via PRP protocol is given in table 112.

Table 112 – Description of redundancy settings via PRP protocol

Group	Parameter	Description
prp	Reception of supervision packets	Enabling tracking of supervision packets. Reception of packets is required to collect statistics and diagnose the PRP network
	Transmission of supervision packets	Enabling generation of supervision packets from this redundancy module. Transmission of packets is required to collect statistics and diagnose the PRP network
	Transmission of VDAN packets	Enabling transmission of supervision VDAN packets. These packets contain additional diagnostic information about network devices connected to the PRP network through the IED redundancy module. Supervision VDAN packets are transmitted only if the Transmit supervision packets parameter is enabled

Ethernet reserving unit settings:

Group	Parameter	Value
Network params	Address	192.168.1.1
	Mask	255.255.255.0
	Gateway	192.168.1.1
	Management VLAN	1
Redundancy	Network redundancy protocol	rstp
Stp	Max age 6..40	20
	Priority	32768
Stp port 1	Port1 path cost 0..200000000	200000
	Port1 auto-edge	<input type="checkbox"/>
	Port1 guard-tcn	<input type="checkbox"/>
	Port1 priority	128
Stp port 2	Port2 path cost 0..200000000	0
	Port2 auto-edge	<input type="checkbox"/>
	Port2 guard-tcn	<input type="checkbox"/>
	Port2 priority	128

Figure 181 – Configuration of redundancy via RSTP protocol

The description of redundancy settings via RSTP protocol is given in table 113.

Table 113 – Description of redundancy settings via RSTP protocol

Group	Parameter	Description
Stp	Max age 6..40	Maximum distance of the extreme switch from the root switch of the network, within which the protocol is applied. For STP protocol it is expressed in seconds
	Priority	Device priority One of the components, as well as part of the MAC address, when added together, a numerical sequence is formed that affects the ranking of switches at the stage of selecting the root switch, selecting the destination path when building a network connection tree from the root switch. The lower the number, the higher the priority. Default value – 32,768. Range of permissible values – from 0 to 65,536
Stp port ½	Port1/2 cost 0..200,000,000	Path “cost” (value, inversely proportional to path throughput). The result of the path cost sum of the current switch and the port cost is the path cost for the next switch. The port with the least cost is selected as the root port – port with the cheapest path to the root switch
	Port1/2 auto-edge	Automatic assignment of port role. It turns on automatic detection of the end device. If there are no BPDU packets from the device, connected to the port, the transmit mode is turned on. Then this port does not participate in the RSTP topology
	Port1/2 guard-tcn	The function of port protection from distribution of messages on network topology change. Enable protection against attack by false BPDU messages on topology change that do not contain information about a better path
	Port1/2 priority	Port priority. The lower the number, the higher the priority. If the port cost turned out to be the same, the selection will be made by priority. Range of permissible values – from 0 to 240 in increments of 16

Ethernet reserving unit settings:

Group	Parameter	Value
Network params	Address	192.168.1.1
	Mask	255.255.255.0
	Gateway	192.168.1.1
	Management VLAN	1
	Network redundancy protocol	linkbackup

Figure 182 – Configuration of redundancy via LinkBackUp protocol

Ethernet reserving unit settings:

Group	Parameter	Value
Network params	Address	192.168.1.1
	Mask	255.255.255.0
	Gateway	192.168.1.1
	Management VLAN	1
Redundancy	Network redundancy protocol	mrp
mrp	Advanced mode	<input type="checkbox"/>
	VLAN ID	0

Figure 183 – Configuration of redundancy via mrp protocol

The description of redundancy settings via mrp protocol is given in table 114.

Table 114 – Description of redundancy settings via mrp protocol

Group	Parameter	Description
mrp	Extended mode	In this mode, a connection failure is detected using the “Link-down” message about a broken connection. This message can be generated by the device that has detected the break
	VLAN ID	Number of the virtual network

5.3.7 Diagnostics parameters

This tab is designed for viewing device failures (figure 184). The description of parameters of the **Diagnostics parameters** tab is given in table 115.

DSP events		Host events	
Name	Custom malfunction parameters	Signal type	Fixation
IRIG-B synchronization error	<input type="checkbox"/>	Warning	<input type="checkbox"/>
External RAM error	<input type="checkbox"/>	Warning	<input checked="" type="checkbox"/>
PPS synchronization error/absence	<input type="checkbox"/>	Warning	<input type="checkbox"/>
CP is not responding	<input type="checkbox"/>	Warning	<input checked="" type="checkbox"/>
Error CRC macrolanguage nonvolatile memory	<input type="checkbox"/>	Warning	<input checked="" type="checkbox"/>
Error synch source destination	<input type="checkbox"/>	Warning	<input checked="" type="checkbox"/>
Out of range Power	<input type="checkbox"/>	Information	<input type="checkbox"/>

Figure 184 – Diagnostics parameters tab

Table 115 – Parameters of the **Diagnostics parameters** tab

Parameter	Description
Name	Flag name
Individual failure parameters	Individual parameters of the failure allow you to change the signal type and latching flag (by default, the box is unchecked, parameters “Signal type” and “Latching” are highlighted in gray and not editable)
Signal type	Alarm, warning, information
Latch	Latching flag allows you to latch the appearance of signals in the IED and reset on user reset

5.3.8 Control mode

This tab is designed to select the control mode and bind the operation of the "Reset" and "Start" signals from a binary input or a device logic signal (figure 185).

IED Local/Remote switching methods:

- Not selected (hotkeys Fn+2 on the front panel are used);
- ES 1 (electronic switch №1);
- Logic signal.

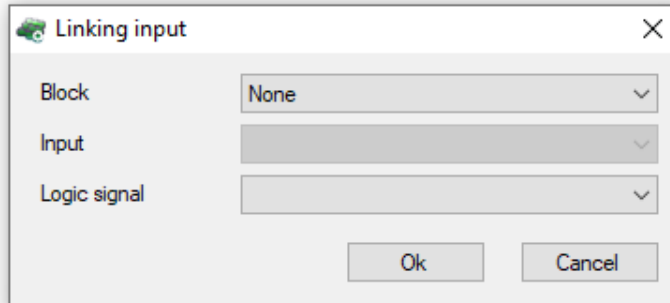
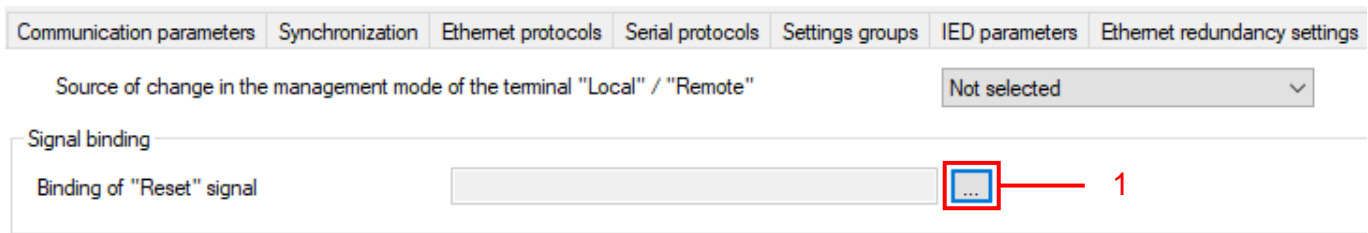

Figure 185 – **Control Mode** tab

Binding of signals occurs by pressing a button (figure 185, pos. 1).

The description of parameters of the **Linking input** is given in table 116.

Table 116 – Description of parameters of the **Linking input**

Parameter	Description
Block	The name of inputs module
Input	Bit number in inputs module
Logic signal	Logic signal number from logic of device. Logic signal selection is not available if an inputs module is selected.

Note – The "Start" signal binding is displayed only for the "Communication Device" functional purpose and is used to enable the receiver to be put into the "Run" state.

5.3.9 Security parameters

This tab is designed to select the level of security of the Modbus protocol (figure 186).

Modbus protocol security level options:

- Off:
 - 1) Modbus protocol security is not used;
- Low:
 - 1) CRC32 hash algorithm;
 - 2) absence of MAC in IED messages;
 - 3) username in client messages (SmartMonitor) is transmitted in clear text;
- Medium:
 - 1) MD5 hash algorithm;
 - 2) absence of MAC in IED messages;
 - 3) username in the client message is transmitted in clear text;

- High;
 - 1) MD5 hash algorithm;
 - 2) presence of MAC in IED messages;
 - 3) username in the client message is transmitted as MD5.

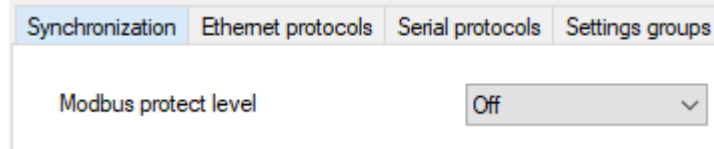

Figure 186 – Security parameters tab

5.4 Logic part

5.4.1 Measuring elements and functions

The **Measuring elements and functions** window, device tree menu **Logic part** → **Measuring elements and functions** (figure 187), allows you to configure measuring elements and functions for the IED. In figure 187, item 1 there is a list of measuring elements and functions available in the project, in figure 187, item 2 – parameters and settings of the selected measuring element.

Measuring element grouping is designed to group measuring elements by logical groups.

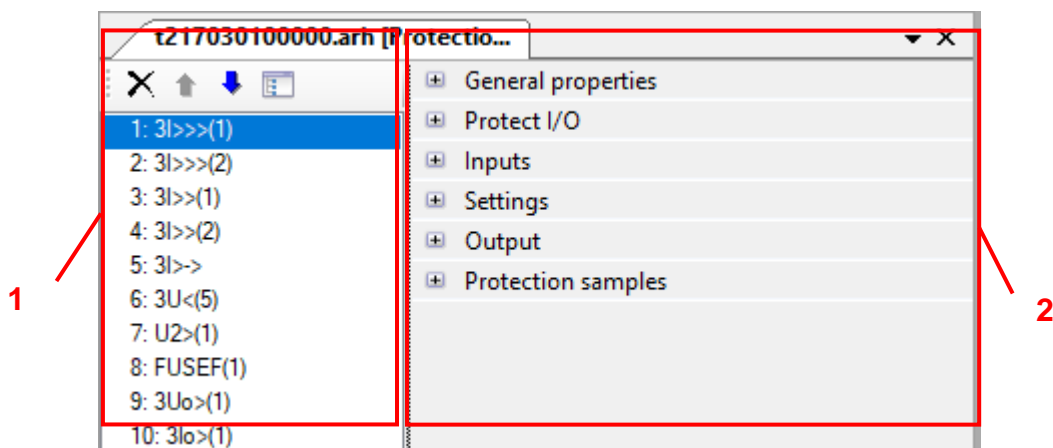

Figure 187 – Measuring elements and functions window

5.4.1.1 Common features

General properties	
Parameter	Value
Id	3I>>>(1)
Library protect	3I > G (f)
Protects group	ANSI 50/51/67/50V/51V/49 ▾
Name	

Figure 188 – General properties section

The description of parameters of the **General properties** section (figure 188) is given in table 117.

Table 117 – Description of parameters of the **General properties** section

Parameter	Description
Designation	Designation of the measuring element or function in the configuration (editable)
Library name	Name of the measuring element or function in the library
Functional group	Name of the group to which the measuring element or function belongs
Description	Description of the measuring element or function (editable)

5.4.1.2 Enable/disable

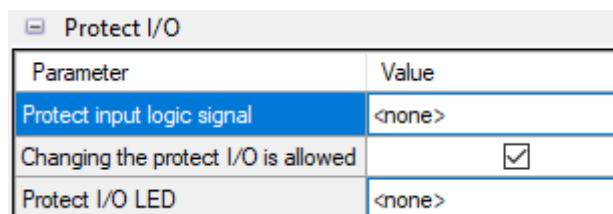

Figure 189 – **Enable/disable** section

The description of parameters of the **Enable/disable** section (figure 189) is given in table 118.

Table 118 – Description of parameters of the **Enable/disable** section

Parameter	Description
Logic signal enable	Setting the logic signal to enable the measuring element or function
Enable condition	If the checkbox is checked, then the measuring element or function can be activated using a logic signal or the Enabled setting (see 5.4.1.4). Otherwise measuring element or function can be activated only via the Enabled setting.
LED enable/disable	Setting the measuring element or function status LED (enable/disable)

5.4.1.3 Inputs

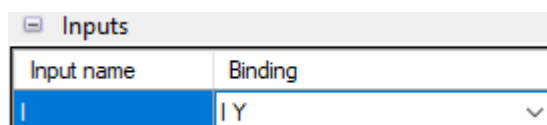

Figure 190 – **Inputs** section

The description of parameters of the **Inputs** section (figure 190) is given in table 119.

Table 119 – Description of parameters of the **Inputs** section

Parameter	Description
Input name	List of measuring element or function inputs
Binding	Binding of the sensor module circuit to the measuring element or function input

Note – If you want to set a name consisting of special characters, you should make sure that they are included in the set of permitted special characters: “Σ Ω Ψ € ∞ ≥ ≈ ÷ ± ≤ ° C ° • Λ V ... ≠ Δ © ® { }”. To set special characters, go to the menu **View** → **Special characters table**.

5.4.1.4 Settings

Settings									
Setting	Setting group 1 (active)	Setting group 2	Setting group 3	Minimum	Maximum	Unit	Unique range	Description	
Protection entered	<input checked="" type="checkbox"/>	<input checked="" type="checkbox"/>	<input checked="" type="checkbox"/>						
Oper.	5.000	5.000	5.000	0.250	200.000	A	<input type="checkbox"/>		
Kret.	0.95	0.95	0.95	0.50	1.00		<input type="checkbox"/>		

Figure 191 – **Settings** section

The description of parameters of the **Settings** section (figure 191) is given in table 120.

Table 120 – Settings

Parameter	Description
Setting	List of measuring element or function settings
Setting group	Value of the setting
Minimum	Minimum value of the setting
Maximum	Maximum value of the setting
Unit	Measurement unit (absolute/relative value)
Unique range	Indicator of enabling assignment of the unique setting range
Description	Description of the measuring element or function setting. By default, this field is empty. Edited by user if necessary
Enabled	Setting of measuring element or function activation

* The quantity of columns depends on the quantity of setting groups in the configuration.

5.4.1.5 Outputs

Output	
Name	Using
Oper. A	<input checked="" type="checkbox"/>
Oper. B	<input checked="" type="checkbox"/>
Oper. C	<input checked="" type="checkbox"/>
Oper.	<input type="checkbox"/>

Figure 192 – **Outputs** section

The description of parameters of the **Outputs** section (figure 192) is given in table 121.

Table 121 – Outputs

Parameter	Description
Name	List of measuring element or function outputs
Use	Using the output in the logic (whether or not to use the measuring element or function output in the logic of the IED, when used, it is added to the logic diagram and the signal table of the IED)

5.4.2 Calculated parameters

Calculated parameters are internal variables of the measuring element or function algorithm with their possible disturbance recording (figure 193).

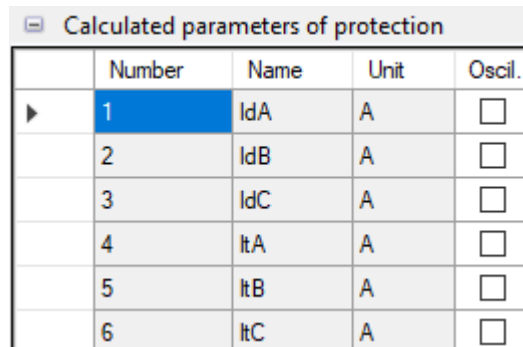

	Number	Name	Unit	Oscil.
▶	1	IdA	A	<input type="checkbox"/>
	2	IdB	A	<input type="checkbox"/>
	3	IdC	A	<input type="checkbox"/>
	4	ItA	A	<input type="checkbox"/>
	5	ItB	A	<input type="checkbox"/>
	6	ItC	A	<input type="checkbox"/>

Figure 193 – **Calculated parameters** section

The description of parameters of the **Calculated parameters** section given in table 122.

Table 122 – Calculated parameters

Parameter	Description
Number	Number of the parameter
Name	Name of the parameter
Unit	Measurement unit of the parameter
Dist.	Disturbance recording of the parameter

5.4.3 Programmable logic

To ensure the correct logic of the IED, the Configurator has a visual editor of logic that allows you creating logic, emulate the operation of logic (simulate the supply of signals to the logic and check the correct execution of the logic), and compile it (a compiled logic file is created that is used in the logic of the IED).

The following signals can be input data for the logic:

- signals received via physical binary inputs and via digital protocols;
- measuring element signals;
- signals of keyboard events;
- service signals;
- system events;
- outputs of specialized buffers;
- results of logic functions of the **Calculated values** section.

Logic signals that are supposed to be used to influence the relay of the IED, assign to local alarm, in digital data transmission protocols, calculations should be displayed in the “Matrix inputs” element.

You can move around the window either by hovering the mouse or using the mouse wheel (vertically).

The **Logic** section has subsections **Logic elements** and **System events**.

5.4.3.1 Opening of programmable logic diagram

To open the diagram, go to device tree menu **Logic part** → **Logic**. The **Logic** window is shown in figure 194.

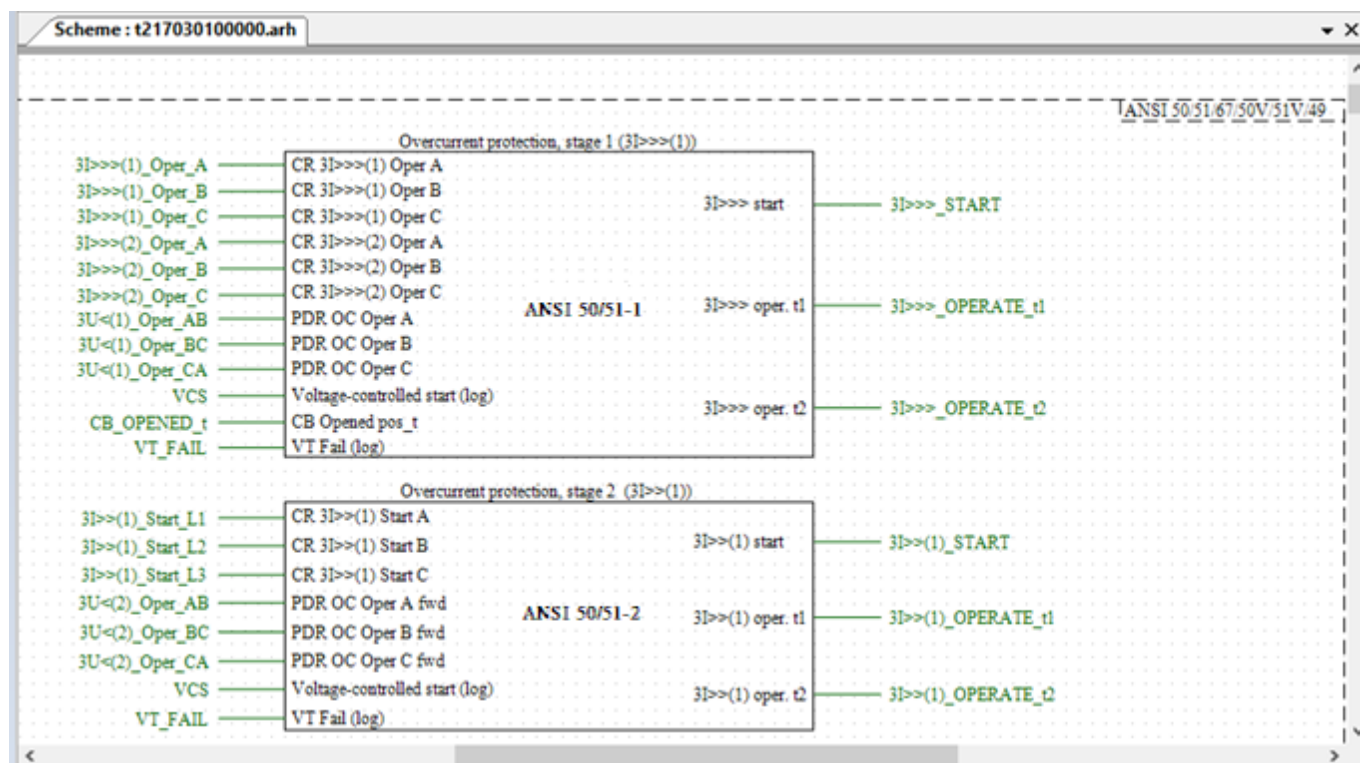

Figure 194 – Programmable logic diagram

The presence of programmable logic in the configuration is indicated by the red glow of the **Programmable logic** button (the **Programmable logic** button is active).

5.4.3.2 Editing of programmable logic diagram

In the programmable logic, elements without settings in the **Library** tab (figure 195, item 1) or with settings in the **Reserved elements of additional logic** tab (figure 195, item 2) can be used. The use of logic elements with settings, as well as R_Trigger and F_Trigger triggers, is strictly limited. These elements are available in the special **Reserved elements of additional logic** window. The maximum number of elements is indicated in brackets, and the available quantity is outside the brackets (figure 195, item 3).

When you hover the mouse cursor over the **Logic library** tab, a window appears with logic elements (figure 196) used in the programmable logic.

By default, in addition to the logic container, there are elements of matrix outputs (16 reserved outputs) and matrix inputs (128 reserved inputs). Matrix inputs are used to assign signals to output relays or to the LED display with possible assignment for event and disturbance recording.

The signals to matrix outputs are assigned by means of the tripping matrix in the configuration.

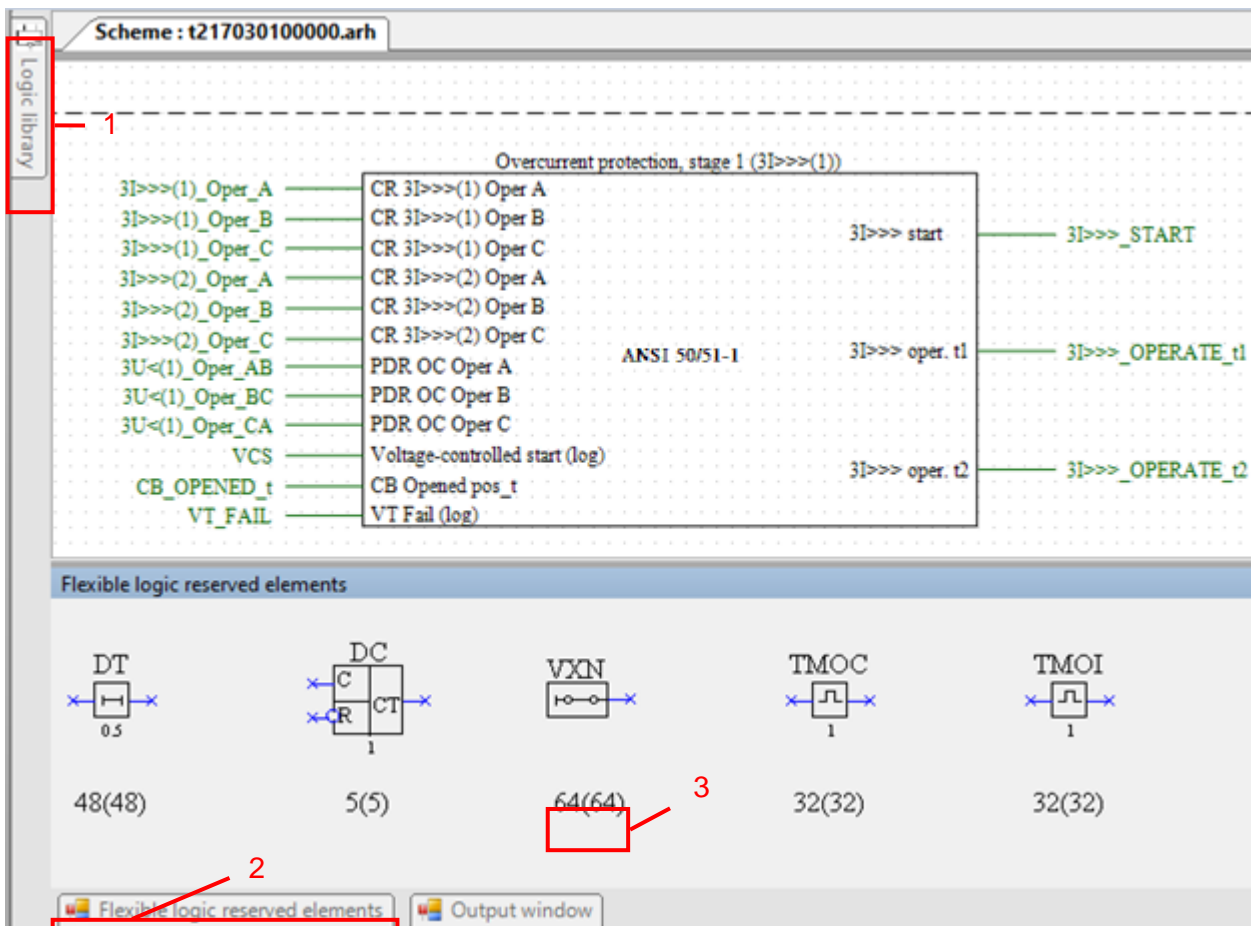

Figure 195 – Editing of programmable logic diagram

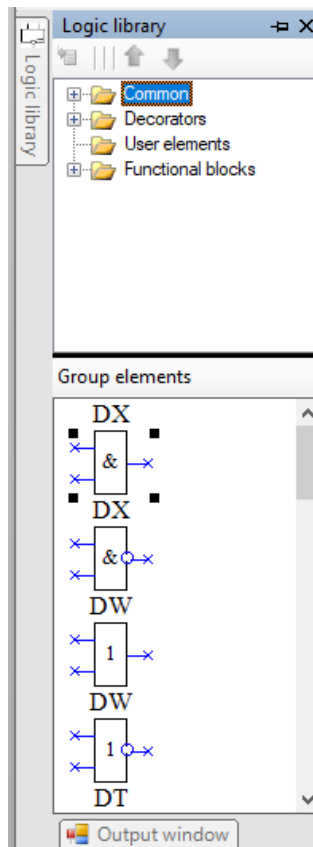

Figure 196 – Programmable logic library

Setting logic connections between elements inside the programmable logic container is performed using lines or logic markers.

Setting logic connections using logic markers is performed as follows:

a) using combination CTRL+SHIFT and left mouse button select the element output marker (output is colored green (figure 197));

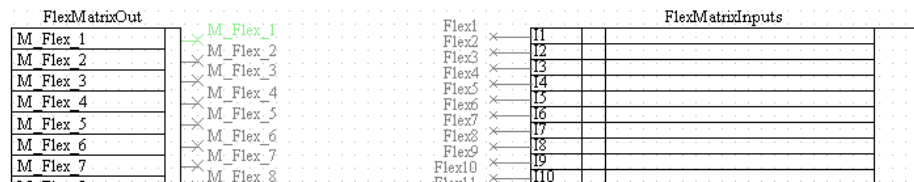

Figure 197 – Setting logic connections

b) using combination CTRL+SHIFT and left mouse button select the necessary element input marker. The marker is bound (figure 198).

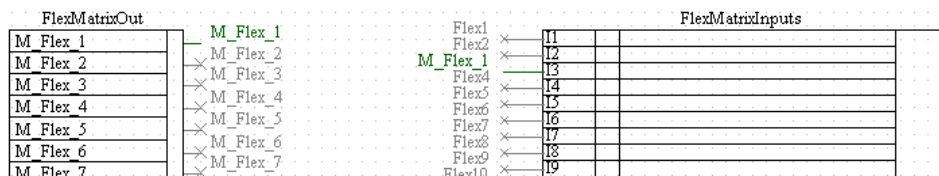

Figure 198 – Binding of programmable logic markers

Logic connections of inputs of logical elements of programmable logic with outputs of hard logic elements can be set using logic markers.

To use a reserved programmable logic element, you must capture its image and drag it with the mouse into the programmable logic container. When you drag reserved items into the programmable logic container, the available quantity of items dynamically changes. Also, in the container of programmable logic, you can use common elements from the logic library – these are elements of type AND, OR, NOT, etc. Placement of logic elements outside the programmable logic container is not available.

If necessary, you can delete elements of the flexible logic diagram with the DELETE button on the keyboard or the **Delete** command in the context menu, which is called by right-clicking on the element.

5.4.3.3 Logic compilation

After editing the programmable logic, it is necessary to check the correctness of the logic using the function of logic compilation. Logic compilation checks for unused outputs of logic elements and the memory footprint of the logic. Logic compilation is started by pressing the **Compile** button on the toolbar (figure 199).

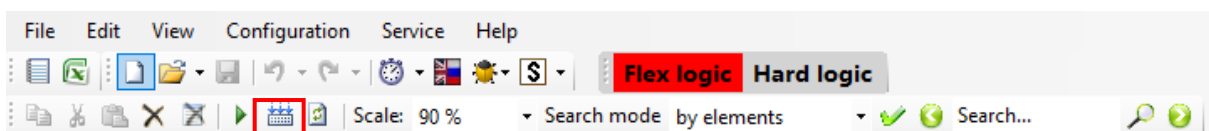

Figure 199 – Location of the **Compile** button

If unused outputs of logic elements are found during compilation, the program informs the user about it and displays a list of unbound outputs on a separate panel (figure 200). To eliminate errors, bind unbound outputs, or mark them as unused outputs (check the box in the **Unused outputs** field).

After eliminating the errors, it is necessary to recompile the logic diagram.

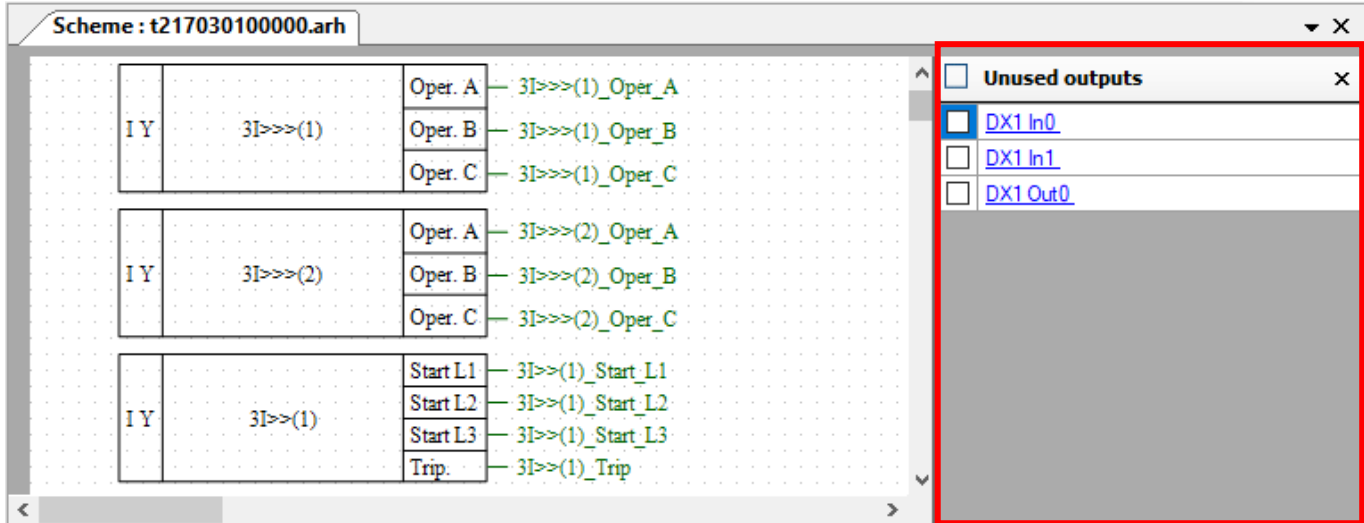

Figure 200 – Location of the list of unbound outputs

In case of successful compilation of the logic, a corresponding message will be displayed (figure 201).

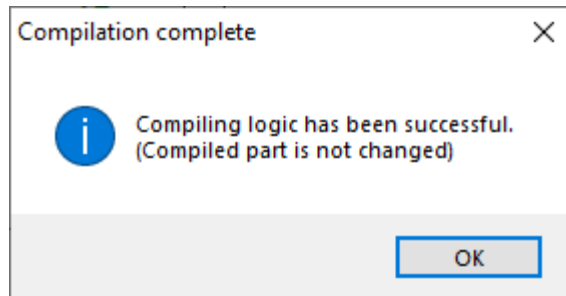

Figure 201 – **Compilation complete** window

5.4.3.4 Assigning settings of programmable logic elements

To open the **Logic elements** window, select device tree menu item **Logic part** → **Logic** → **Logic elements** (figure 202).

The reserved programmable logic elements have the following settings:

- time delays;
- program switches;
- pulse former;
- stage counters;
- pulse generators.

Logic elements used in programmable logic are labeled “programmable logic” in the **Belongs to** column.

Protect	Name	Type	Minimum, s	Maximum, s	Editable from ARM and terminal display	Belonging	Description RU	Description EN
ANSI 50/51/67/50V/51V/49	3>>>(1)_Oper_t1	Operating	0.000	9.999.000	<input checked="" type="checkbox"/>	hard logic	Выдержка врем...	Actuation Time Delay
	3>>>(1)_Oper_t2	Operating	0.000	9.999.000	<input checked="" type="checkbox"/>	hard logic	Выдержка врем...	Actuation Time Delay
	3>>>(1)_Oper_t1	Operating	0.000	9.999.000	<input checked="" type="checkbox"/>	hard logic	Выдержка врем...	Actuation Time Delay
	3>>>(1)_Oper_t2	Operating	0.000	9.999.000	<input checked="" type="checkbox"/>	hard logic	Выдержка врем...	Actuation Time Delay
	3>>>(2)_Oper_t1	Operating	0.000	9.999.000	<input checked="" type="checkbox"/>	hard logic	Выдержка врем...	Actuation Time Delay
	3>>>(2)_Oper_t2	Operating	0.000	9.999.000	<input checked="" type="checkbox"/>	hard logic	Выдержка врем...	Actuation Time Delay
Acceleration	Acceleration	Operating	0.000	9.999.000	<input checked="" type="checkbox"/>	hard logic	Выдержка врем...	Actuation Time Delay
ANSI 60, FUSEF	VT_Fail	Operating	0.000	9.999.000	<input checked="" type="checkbox"/>	hard logic	Выдержка врем...	Actuation Time Delay
	FUSEF_Oper	Operating	0.000	9.999.000	<input checked="" type="checkbox"/>	hard logic	Выдержка врем...	Actuation Time Delay
ANSI 51/49	3I>(1)_Oper	Operating	0.000	9.999.000	<input checked="" type="checkbox"/>	hard logic	Выдержка врем...	Actuation Time Delay
	3I>(2)_Oper	Operating	0.000	9.999.000	<input checked="" type="checkbox"/>	hard logic	Выдержка врем...	Actuation Time Delay
Gas protection	GP_Oper	Operating	0.000	9.999.000	<input checked="" type="checkbox"/>	hard logic	Выдержка врем...	Actuation Time Delay
	GP_Alarm	Operating	0.000	9.999.000	<input checked="" type="checkbox"/>	hard logic	Выдержка врем...	Actuation Time Delay

Setting group	Setting, sec
Setting group 1 (active)	0.600
Setting group 2	0.600
Setting group 3	0.600

Figure 202 – Logic elements window

To save the configuration, select main menu item **File** → **Save**. All setting groups are saved in one configuration file.

5.4.3.5 Logic elements

The **Logic elements** window, device tree menu **Logic part** → **Logic** → **Logic elements** (figure 202), is designed for editing the settings of logic elements present in the logic diagram. Types of logic elements are sorted by tabs.

1) Time delays

Figure 202 shows the form for setting the time delay parameters.

The description of columns of the time delays table is given in table 123.

Table 123 – Description of columns of the time delays table

Parameter	Description
Measuring element	Belonging of the logic element to the measuring element
Name	Name of the element in the logic diagram
Type	Type of time delay (operate or release)
Minimum, s	Minimum value of the setting in seconds
Maximum, s	Maximum value of the setting in seconds
Editable via Smart Monitor and IED menu	Parameter specifying the possibility to record the settings of this element in the Smart Monitor program
Description in Russian	Description of the element in Russian
Description in English	Description of the element in English
Setting group	Name of the setting group
Setting, s	Value of the setting in seconds

2) Program switches

Figure 203 shows the form for setting the parameters of program switches.

Protect	Name	Editable from ARM and terminal display	Belonging	Description RU	Description EN	Setting group	Setting
ANSI 50/51/67/50V/51V/49	3 >>>(1)_Auto_set_desens	<input checked="" type="checkbox"/>	hard logic	Автомат. заруб.уста...	Automatic setting desensitization: 1-...	Setting group 1 (active)	<input type="checkbox"/>
	3 >>>(1)_Dir_VT_Fail	<input checked="" type="checkbox"/>	hard logic	Действ. направ.МТ3-...	Directional l>>> mode when VT fail...	Setting group 2	<input type="checkbox"/>
	3 >>>(1)_Dir_control	<input checked="" type="checkbox"/>	hard logic	Конт. направ. МТ3-1: ...	l>>> direction control: 1=yes, 0=no	Setting group 3	<input type="checkbox"/>
	3 >>>(1)_VCS	<input checked="" type="checkbox"/>	hard logic	Пуск по напр. МТ3-1: ...	l>>> voltage-controlled start: 1=yes, ...		
	3 >>(1)_Dir_VT_Fail	<input checked="" type="checkbox"/>	hard logic	Действ. направ.МТ3-...	Directional l>>(1) mode when VT fai..		
	3 >>(1)_Dir_control	<input checked="" type="checkbox"/>	hard logic	Конт. направ. МТ3-2: ...	l>>(1) direction control: 1=yes, 0=no		
	3 >>(1)_VCS	<input checked="" type="checkbox"/>	hard logic	Пуск по напр. МТ3-2: ...	l>>(1) voltage-controlled start: 1=yes...		
	3 >>(2)_Dir_VT_Fail	<input checked="" type="checkbox"/>	hard logic	Действ. направ.МТ3-...	Directional l>>(2) mode when VT fai..		
	3 >>(2)_Dir_control	<input checked="" type="checkbox"/>	hard logic	Конт. направ. МТ3-3: ...	l>>(2) direction control: 1=yes, 0=no		
Acceleration	Accel_ >>(1)	<input checked="" type="checkbox"/>	hard logic	Ускорение МТ3-2: 1-...	Acceleration of l>>(1): 1=yes, 0=no		
	Accel_ >>(2)	<input checked="" type="checkbox"/>	hard logic	Ускорение МТ3-2: 1-...	Acceleration of l>>(2): 1=yes, 0=no		

Figure 203 – Program switches tab

The description of columns of the time program switches table is given in table 124.

Table 124 – Description of columns of the time delays table

Parameter	Description
Measuring element	Belonging of the logic element to the measuring element
Name	Name of the element in the logic diagram
Editable via Smart Monitor and IED menu	Parameter specifying the possibility to record the settings of this element in the Smart Monitor program
Belongs to	Type of logic to which the logic element belongs (hard or programmable logic)
Description in Russian	Description of the element in Russian
Description in English	Description of the element in English
Setting group	Name of the setting group
Setting	State of program switches

3) Pulse shapers

Figure 204 shows the form for setting the parameters of pulse shapers.

Protect	Name	Minimum, s	Maximum, s	Editable from ARM and terminal display	Belonging	Description RU	Description EN	Setting group	Setting, sec
Open Command circuits	TMOC1	0.001	9.999.000	<input checked="" type="checkbox"/>	hard logic	Длительность импульса		Setting group 1 (active)	1.000
								Setting group 2	1.000
								Setting group 3	1.000

Figure 204 – Pulse shapers tab

The description of columns of the pulse shapers table is given in table 125.

Table 125 – Description of columns of the pulse shapers table

Parameter	Description
Measuring element	Belonging of the logic element to a measuring element
Name	Name of the element in the logic diagram
Minimum, s	Minimum value of the setting in seconds
Maximum, s	Maximum value of the setting in seconds
Editable via Smart Monitor and IED menu	Parameter specifying the possibility to record the settings of this element in the Smart Monitor program and IED menu
Belongs to	Type of logic to which the logic element belongs (hard or programmable logic)
Description in Russian	Description of the element in Russian
Description in English	Description of the element in English
Setting group	Name of the setting group
Setting, s	Pulse length in seconds

4) Pulse shapers with interruption

Figure 205 shows the form for setting the parameters of pulse shapers with interruption.

Protect	Name	Minimum, s	Maximum, s	Editable from ARM and terminal display	Belonging	Description RU	Description EN	Setting group	Setting, sec
ANSI 27	TMO1	0.001	9.999.000	<input checked="" type="checkbox"/>	hard logic	Длительность импульс...		Setting group 1 (active)	1.000
	TMO2	0.001	9.999.000	<input checked="" type="checkbox"/>	hard logic	Длительность импульс...		Setting group 2	1.000
Close Command circuits	Close_sig...	0.001	9.999.000	<input checked="" type="checkbox"/>	hard logic	Длительность импульс...		Setting group 3	1.000
Auxiliary signals	TMO13	0.001	9.999.000	<input checked="" type="checkbox"/>	hard logic	Длительность импульс...			

Figure 205 – Pulse shapers with interruption tab

The description of columns of the table of pulse shapers with interruption is given in table 126.

Table 126 – Description of columns of the pulse shapers table

Parameter	Description
Measuring element	Belonging of the logic element to the measuring element
Name	Name of the element in the logic diagram
Minimum, s	Minimum value of the setting in seconds
Maximum, s	Maximum value of the setting in seconds
Editable via Smart Monitor and IED menu	Parameter specifying the possibility to record the settings of this element in the Smart Monitor program and IED menu
Belongs to	Type of logic to which the logic element belongs (hard or programmable logic)
Description in Russian	Description of the element in Russian
Description in English	Description of the element in English

Parameter	Description
Setting group	Name of the setting group
Setting, s	Pulse length in seconds

5.4.3.6 Logic simulation and compilation

Logic emulation is used to test the operation of the logic. The simulation mode is started and stopped by pressing the **Simulate** button (figure 206) in the toolbar of the **Logic** form. The current logic simulation speed is taken as a factor of 1, the logic execution speed can be adjusted from 0.01 to 60.

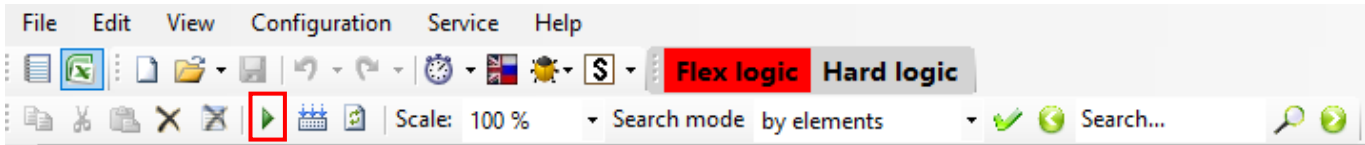

Figure 206 – Location of the **Simulate** button

Before the logic is simulated, the logic is automatically compiled. To compile the logic manually, use the **Compile** button (figure 199).

5.4.3.7 System events

The **System events** window, device tree menu **Logic part** → **Logic** → **System events** (figure 207), is designed for transmitting system events to the logic. It consists of a list of events of the communication (CP) and functional (FP) processors.

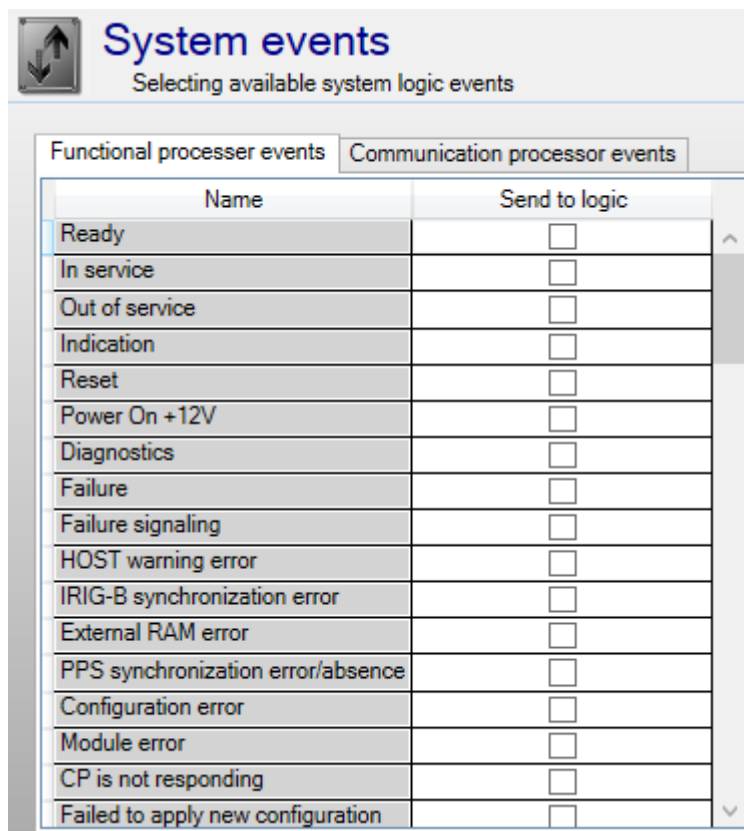

Figure 207 – **System events** window

Parameters of system events are shown in table 127.

Table 127 – Parameters of system events

Parameter	Description
Name	List of system events
Transmit to logic	Transmission of events to the logic (transmit or not a system event to the IED logic)

5.4.4 IED signals table

The **IED signals table** window, device tree menu **Logic part** → **IED signals table** (figure 208), is designed for configuring matrix inputs. It consists of a list of service signals, measuring element signals, input circuits, logic signals. For the measuring element signal or input circuit, you can create corresponding calculated signals using the context menu.

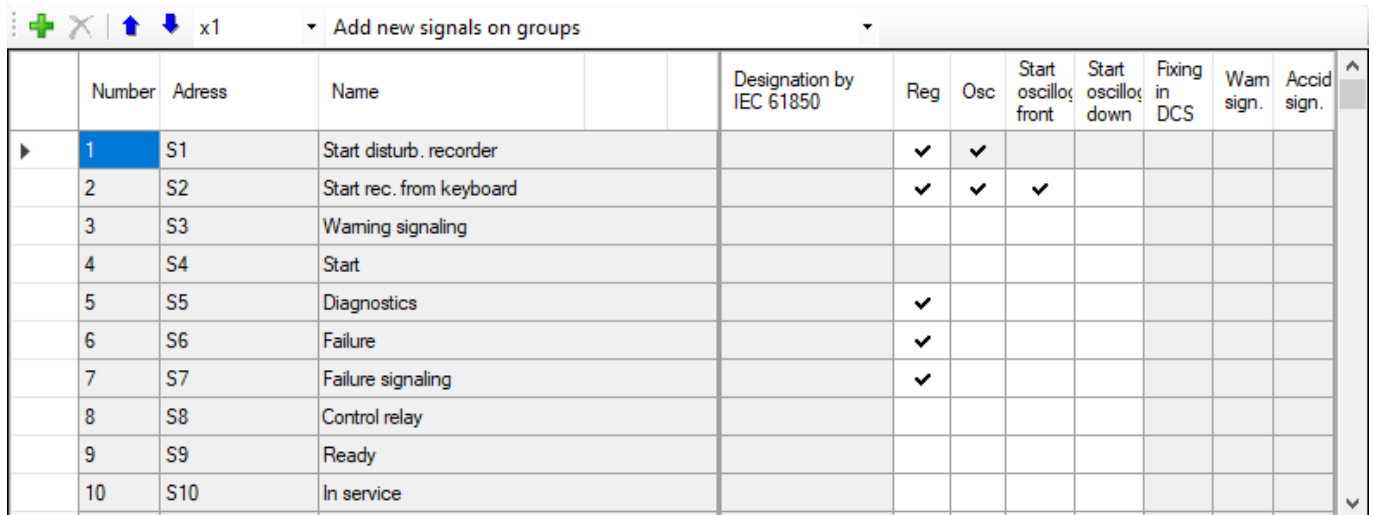

	Number	Address	Name	Designation by IEC 61850	Reg	Osc	Start oscillo front	Start oscillo down	Fixing in DCS	Warn sign.	Accid sign.
▶	1	S1	Start disturb. recorder		✓	✓					
	2	S2	Start rec. from keyboard		✓	✓	✓				
	3	S3	Warning signaling								
	4	S4	Start								
	5	S5	Diagnostics		✓						
	6	S6	Failure		✓						
	7	S7	Failure signaling		✓						
	8	S8	Control relay								
	9	S9	Ready								
	10	S10	In service								

Figure 208 – IED signals table window

Parameters of the list of IED signals table are shown in Table 128.

Table 128 – List parameters

Parameter	Description
Number	Number of the signal input
Address	Address of the signal
Description	Description of the signal in the configuration
Name as per IEC 61850	Name of the signal in the configuration according to IEC 61850-8-1
Event rec.	Indicator of signal event recording
Disturb. rec.	Indicator of signal disturbance recording
Disturb. rec. edge-trig. start	Start of the disturbance recorder on signal rise
Disturb. rec. fall-trig. start	Start of the disturbance recorder on signal fall
Latch. in PCS	Latching the signal for transmission to PCS via ModbusRTU/TCP. Signals are reset after alarm removal

Parameter	Description
Warning alarm	If the box is checked, then when the signal switches from 0 to 1, the service signal "Warning alarm" will be set
Emergency alarm	If the box is checked, then when the signal switches from 0 to 1, the service signal "Emergency alarm" will be set

5.4.5 Matrix of binary outputs

The **Matrix of binary outputs** window, device tree menu **Logic part** → **Matrix of binary outputs** (figure 209), is designed for configuring binary outputs. Each tab of the form corresponds to the output module specified in the **Modules** section. The columns of the matrix correspond to the bits of output modules, and the rows correspond to binary outputs of the IED. A mouse click on a table cell sets the correspondence between the output signal and the bit of the output module. The tabs at the top of the form allow you to switch between output modules of the IED.

For each bit of the output module, the "Latching" mode can be set. This mode ensures that the logical "1" signal is latched at the relay output until the alarm reset command is executed.

Setting indicator "Changing signal assignment" allows you to change the effect on the module output.

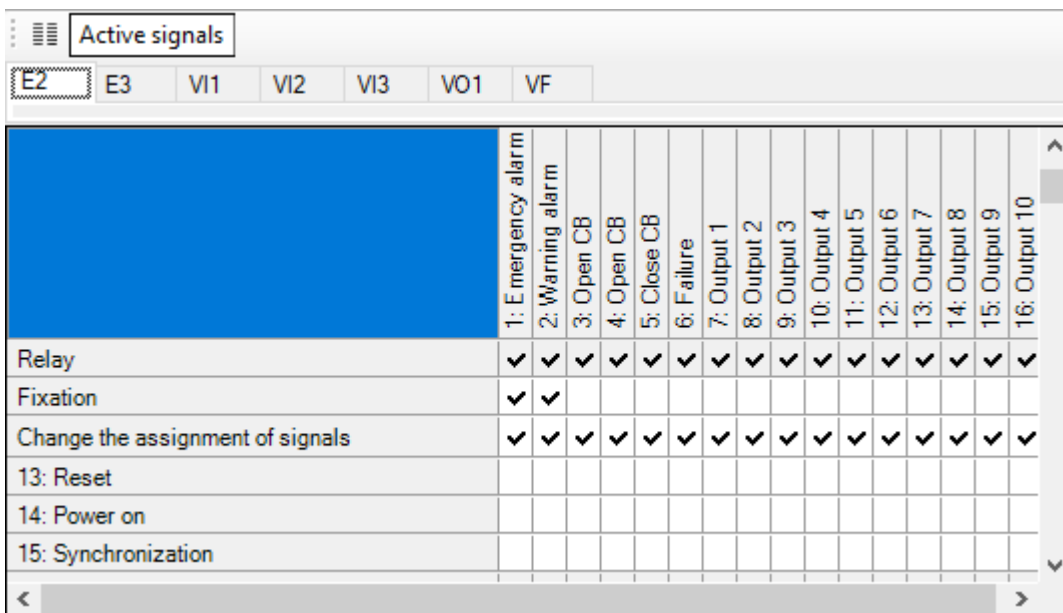

Figure 209 – Output circuits matrix window

5.4.6 Indication matrix

The **Indication matrix** window, device tree menu **Logic part** → **Indication matrix** (figure 210), is designed for configuring the indication module of the IED.

Tabs allow you to switch between groups of bits of the indication module. The LED color is specified in the indication table (red or green). The columns of the table correspond to the names of indication module bits. The names can be edited using the **Modules** menu.

For each bit of the indication module, "Latching" mode can be specified. This mode ensures that the logical "1" signal is latched on the LED until the alarm reset command is executed.

Setting indicator “Changing signal assignment” allows you to change the effect on the LED of the indication module.

	1: Start local disturbance recorder	2: Warning alarm	3: Diagnostics	4: Emergency alarm	5: In service	6: Out of service	7: Reset	8: CB Opened position	9: CB Closed position	10: Truck rolled in	11: Control circuits failure	12:
LED Color	●	●	●	●	●	●	●	●	●	●	●	●
Fixation	▼	▼	▼									
Change the assignment of signals								☑	☑	☑	☑	☑
1: Start disturb. recorder	▼											
2: Start rec. from keyboard												
3: Warning signaling		▼										
4: Start												
5: Diagnostics			▼									
6: Failure												

Figure 210 – Indication matrix window

5.4.7 Event recorder

The **Event recorder** window, device tree menu **Logic part** → **Event recorder** (figure 211), is designed to configure the event recorder.

Recorder groups	Registrar group events		
<ul style="list-style-type: none"> Signals DSP Matrix inputs Incoming circuits enable/disable Matrix outputs Signals SSF Calculated values GOOSE In 			
	Permission	Registration	Show on display
	<input type="checkbox"/>	<input type="checkbox"/>	<input type="checkbox"/>
1: Ready	<input type="checkbox"/>	<input type="checkbox"/>	<input type="checkbox"/>
2: In service	<input type="checkbox"/>	<input type="checkbox"/>	<input type="checkbox"/>
3: Out of service	<input type="checkbox"/>	<input type="checkbox"/>	<input type="checkbox"/>
4: Indication	<input type="checkbox"/>	<input type="checkbox"/>	<input type="checkbox"/>
5: Reset	<input type="checkbox"/>	<input type="checkbox"/>	<input type="checkbox"/>
6: Power On +12V	<input type="checkbox"/>	<input type="checkbox"/>	<input type="checkbox"/>
7: Diagnostics	<input type="checkbox"/>	<input type="checkbox"/>	<input type="checkbox"/>
8: Failure	<input type="checkbox"/>	<input type="checkbox"/>	<input type="checkbox"/>
9: Failure signaling	<input type="checkbox"/>	<input type="checkbox"/>	<input type="checkbox"/>
10: HOST warning error	<input type="checkbox"/>	<input type="checkbox"/>	<input type="checkbox"/>
11: IRIG-B synchronization error	<input type="checkbox"/>	<input type="checkbox"/>	<input type="checkbox"/>
12: External RAM error	<input type="checkbox"/>	<input type="checkbox"/>	<input type="checkbox"/>
13: PU warning	<input type="checkbox"/>	<input type="checkbox"/>	<input type="checkbox"/>
14: PPS synchronization error/absence	<input type="checkbox"/>	<input type="checkbox"/>	<input type="checkbox"/>
15: Configuration error	<input type="checkbox"/>	<input type="checkbox"/>	<input type="checkbox"/>
16: Module error	<input type="checkbox"/>	<input type="checkbox"/>	<input type="checkbox"/>

Figure 211 – **Event recorder** window

The contents of signal tables of recorder groups depend on the selected list item. Each event has the following options:

- Permission – allows setting checkboxes for the parameters "Registration" and "Shown on display";
- Recording – enables signal recording;
- Display – indicator of signal display on the IED.

5.4.8 Disturbance recording

The **Disturbance recorder** window, device tree menu **Logic part** → **Disturbance recorder** (figure 212), is designed for setting the disturbance recorder.

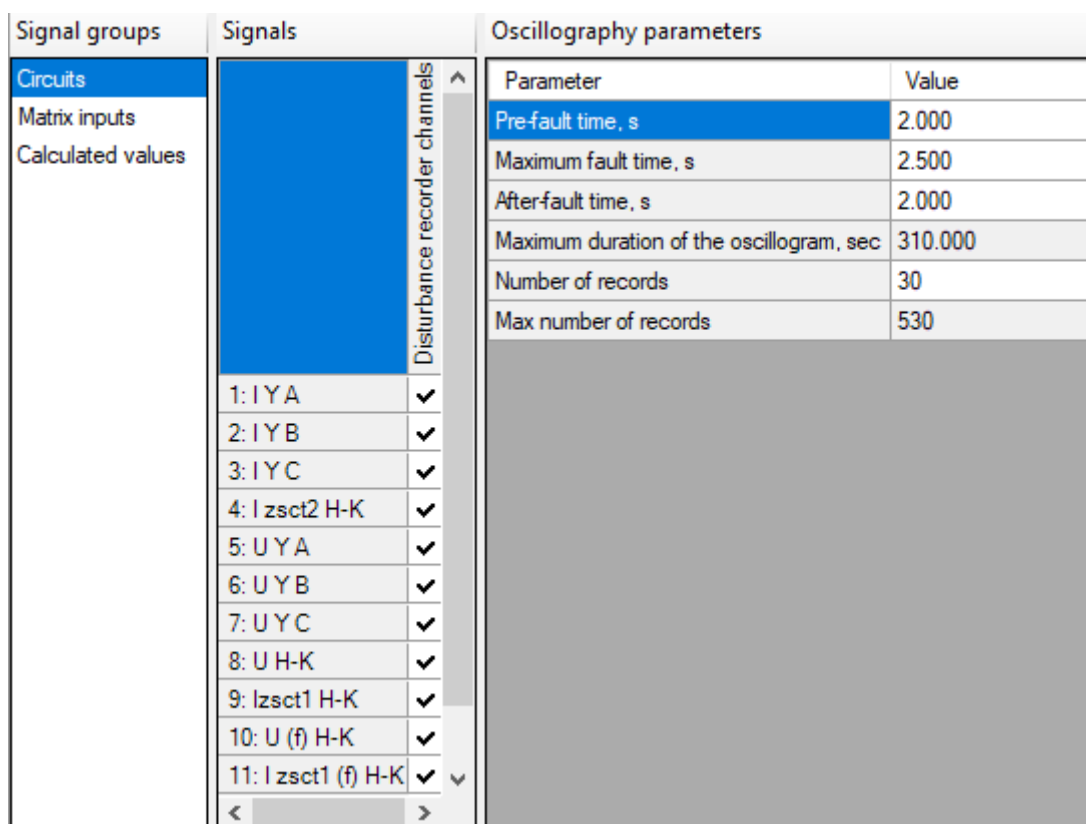

Figure 212 – Disturbance recording window

The **Signal groups** panel provides a choice between binary and analog signals for disturbance recording. To enable disturbance recording, check the box next to the desired signal in the table.

Parameters of disturbance recording are shown in table 129.

Table 129 – Parameters of disturbance recorder

Parameter	Description
Pre-fault time, s	Time before fault, which will be included in the disturbance record in seconds
Maximum fault time, s	Fault time, which will be included in the disturbance record in seconds
Post-fault time, s	Time after fault, which will be included in the disturbance record in seconds
Maximum dist. record duration, s	Display of maximum possible duration of the disturbance record in seconds
Quantity of dist. recorder	Quantity of disturbance records that can be recorded (not greater than the value in Max. quantity of dist. recorder)
Max. quantity of dist. recorder	Maximum quantity of disturbance records that can be recorded

5.4.9 Measurements for indication

The **Measurements for indication** window, device tree menu **Logic part** → **Measurements for indication** (figure 213), is designed to create a list of measurements displayed on the device when a signal is applied to the binary input “Call”.

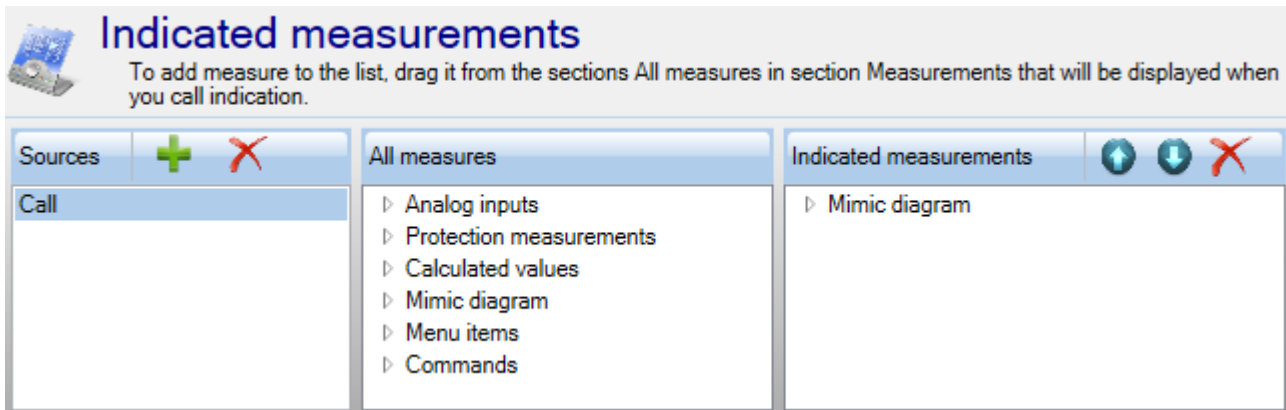

Figure 213 – **Measurements for indication** window

In order to add a measurement, you need to drag it from the **All measurements** tree to the **Measurements for indication** section. Measurement parameters can be specified in the drop-down list.

1) Analog inputs

The description of measurement parameters is shown in table 130.

Table 130 – Description of measurement parameters

Measurement type	Description
Absolute value	Converted primary value of the analog input relative to sensor rating
Rated value	Relative value of the analog input to its rating
Primary value	Signal value released from the protection facility (transformer, generator)
Angle	Phase angle of the corresponding input signal in degrees
Frequency	Input frequency in Hertz

2) Measuring elements

This group of measurements combines all configuration measuring elements. The measuring element contains measurements of inputs, outputs, phasors and calculated measurements. The phase and the type of measurement are specified for measuring element inputs according to table 130. The type of measurement is specified for phasors according to table 130.

3) Calculated values

The current value of calculated measurements set in the configuration is specified.

4) Mimic diagram

The page of the graphical diagram, which will be displayed on the IED.

5.4.10 Mimic diagram

The **Mimic diagram** window, device tree menu **Logic part** → **Mimic diagram** (figure 214), is designed to create a graphical diagram that will be displayed on the IED.

The mimic diagram consists of two parts: a library of elements (figure 214, item 1) and a workspace (figure 214, item 2).

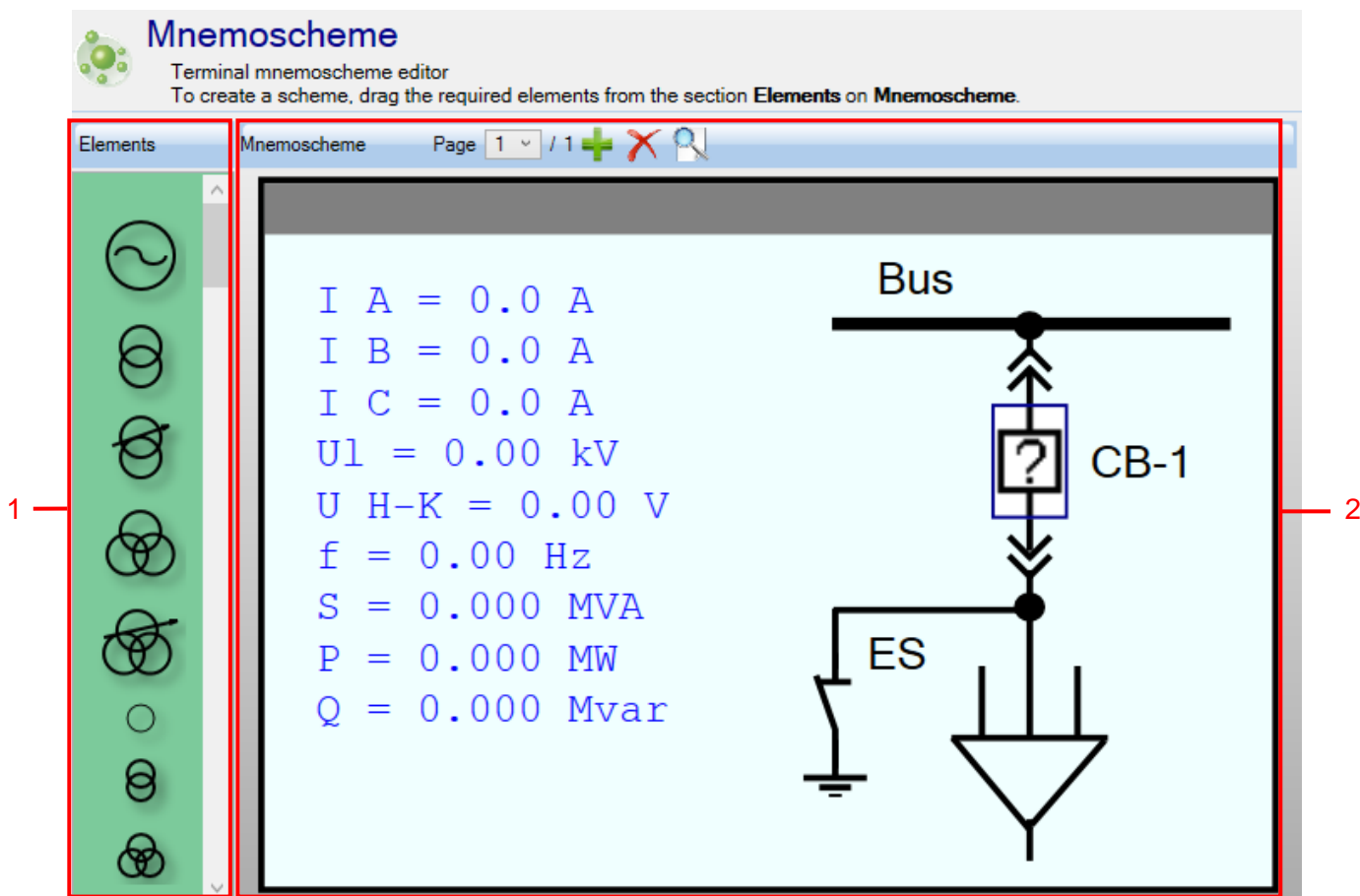





Figure 214 – Mimic diagram window

In the center of the workspace there is an image of the IED display. To create a mimic diagram, you need to move the elements from the library to the workspace. On the workspace panel there are buttons for managing the pages of the mimic diagram. With their help, you can navigate between pages, as well as add and delete pages using the  and  buttons, respectively.

In the Configurator program, it is possible to preview the mimic diagram in the form in which it will be displayed on the IED panel. To do this, press button  on the workspace panel, after which the window shown in figure 215 will appear.

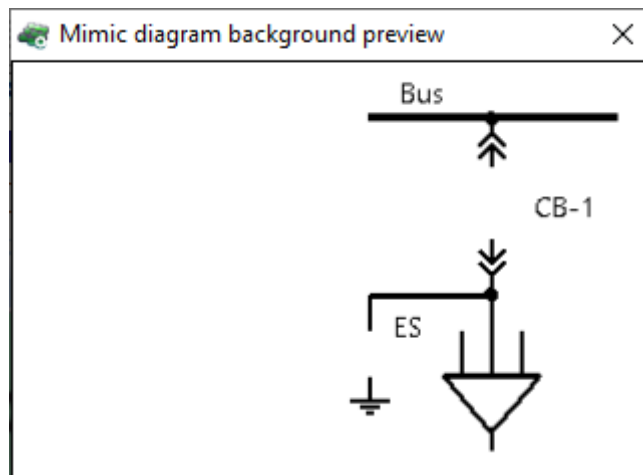

Figure 215 – Viewing the mimic diagram background

There are two types of elements – static and dynamic. Static elements are unchangeable, while dynamic elements can change their state during the operation of the IED. Elements **Disconnecter**, **Circuit-breaker**, **Trolley**, **Lock** change their graphical representation based on the selected calculated measurement. To customize these elements, drag them to the workspace and click on them with the right mouse button (figure 216).

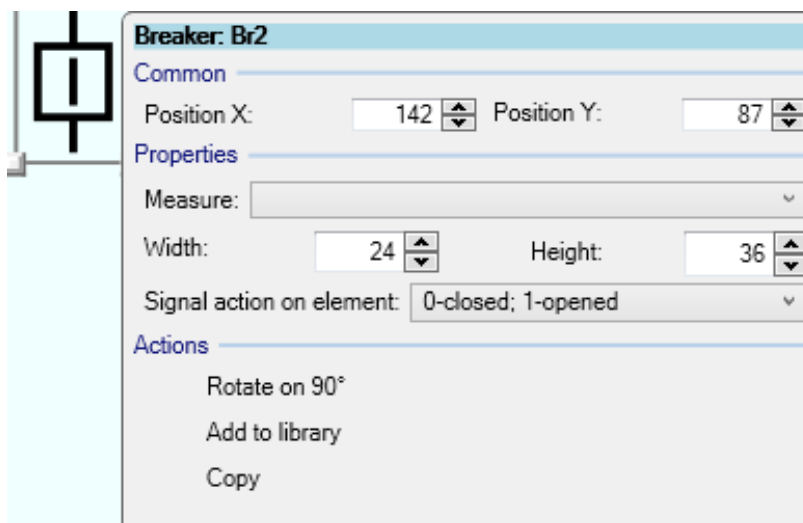

Figure 216 – Setting the **Circuit-breaker** element

It is possible to select a measurement, which actuates the element and the actuation mechanism in the **Properties** group. The measurement corresponds to calculated measurements of the corresponding menu item. **Disconnecter**, **Circuit-breaker** type elements can have only two statuses: closed and tripped. To create a circuit-breaker with four or more statuses, a user dynamic element is used. The impact of the signal on the element is adjusted through the context menu item of the same name.

The **Measurement** element is designed to display the calculated measurement on the mimic diagram window.

In the properties of this element, you can specify the calculated measurement, position, set the designation manually, as well as the accuracy with which it will be displayed on the screen of the mimic diagram.

The **Link** element is designed for switching between the pages of the mimic diagram (figure 217).

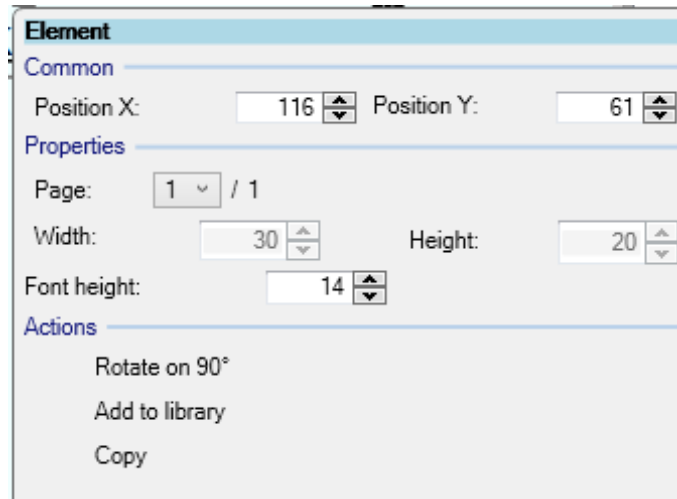

Figure 217 – Setting the **Link** element

In the properties of this element, you must specify the number of the mimic diagram page. It is possible to create a user element with an adjustable quantity of statuses (figure 218).

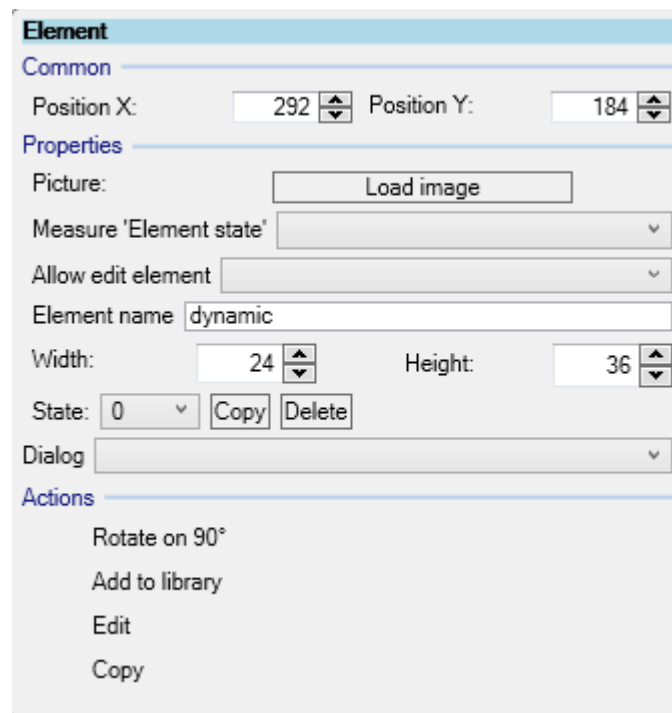

Figure 218 – Properties of the element with an adjustable quantity of statuses

The properties of the user element set the quantity of statuses. Currently, the IED supports a user element with two statuses. For the bay controller, you can also create four statuses in this element. To add a status to the drop-down list, press the “+” button, to delete it “-”. In order to set the status activation condition, select a signal from the drop-down list and set the activation signal status using the **Element status measurement** (figure 219). Activation signals are measurements from the **Calculated measurements** section. For each status of the dynamic element, you must create its graphical representation, otherwise the dynamic element will look empty. To create a picture of the status, it is necessary to select EKRA SMS-SP software package manual EKRA.00019-01 34 02, Edition 05.2023

the desired state from the drop-down list from the context menu of the **Image** element, and then select the **Edit** menu item. While in edit mode, you can drag elements from the library inside the dynamic element, thus creating a graphical representation of the current status. To finish editing the status, click the **Save** button from the context menu of the element.

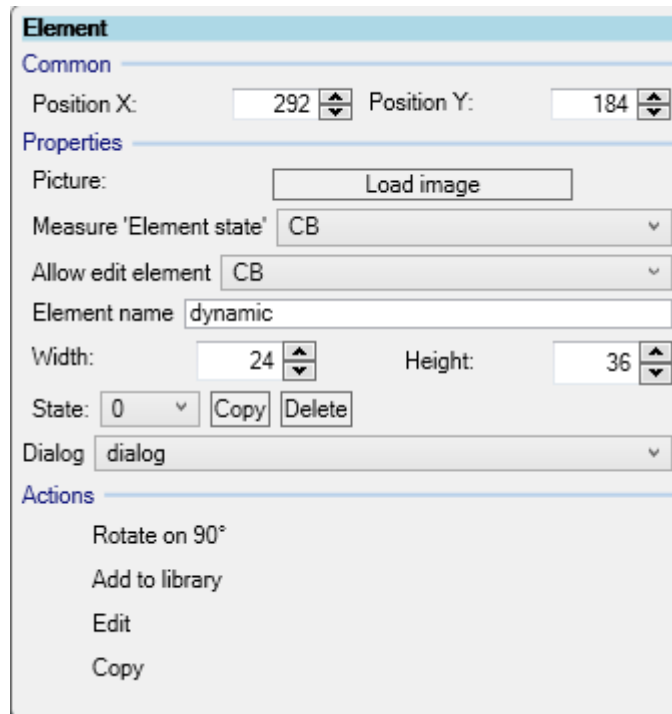

Figure 219 – Element properties with an option to set the activation signal status

The “+” button adds a new status, “x” – deletes the signal.

There are common actions for all elements of the mimic diagram:

- Rotate by 90° – element rotation by 90°.

Note – The “connecting line” element can be rotated to any angle. To rotate the line, pull the edge of its bounding rectangle by pressing the CTRL key;

- Group – joining a group of selected elements;

– Add to library – adding the current selected element (or several grouped elements) to the library (the element is saved to the project file).

5.4.10.1 Mimic diagram dialogs

It is possible to set dialogs when controlling through the mimic diagram. This feature is needed when confirming or refusing user actions when setting control actions through the mimic diagram of the IED. Dialogs can be linked in a chain of two dialogs, i.e. when you click on the button in the first dialog, the second dialog appears. Dialogs are used to configure bay controller projects (figure 220).

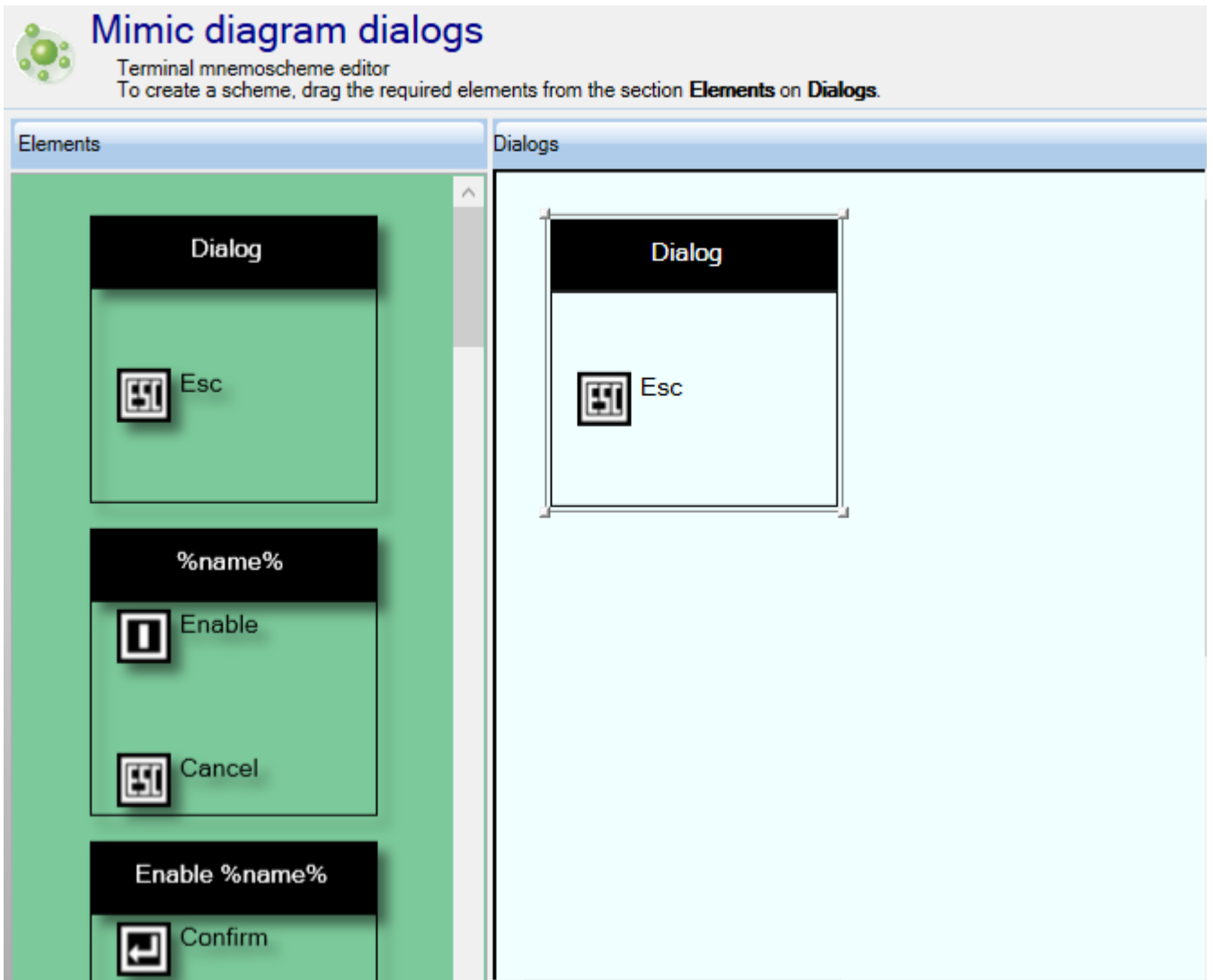

Figure 220 – Mimic diagram dialogs

By default, in the left part of the window there is a standard dialog box, which can be used as a base for creating your own dialog boxes. To do this, it is necessary to move the basic dialog box to the workspace with a mouse. Each dialog box contains a set of properties, which are available through the context menu (figure 221). With **Add to library** button, a dialog box can be added to the user library of dialog boxes. You can add up to two additional buttons using the **Add button** button. The maximum quantity of buttons in the dialog box is three. The **Delete button** button removes additional buttons one by one. There must be at least one ESC button left in the dialog.

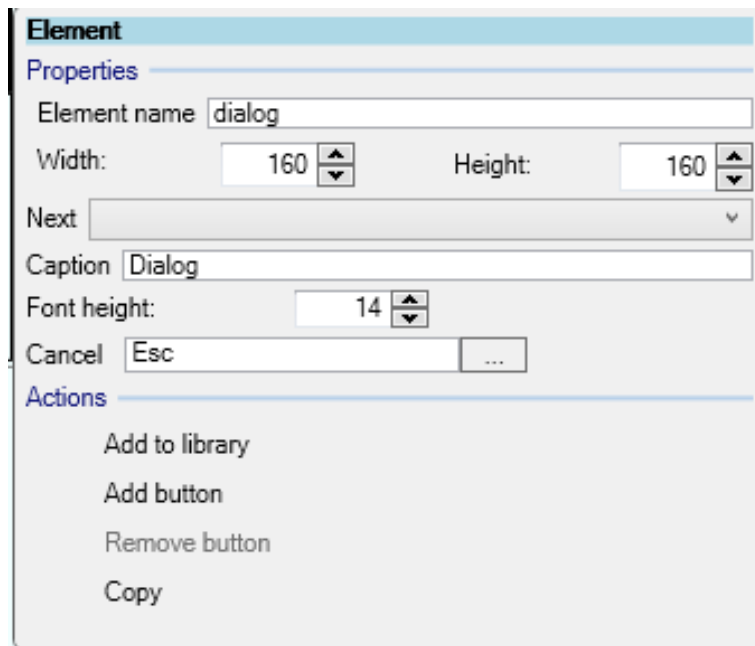

Figure 221 – Element properties

The properties of the dialog box are shown in table 131.

Table 131 – Properties of the dialog box

Parameter	Description
Element name	Dialog identifier
Width	Width of the dialog in the window of the mimic diagram
Height	Height of the dialog in the window of the mimic diagram
Next	Dialog next in the chain
Title	Title of the dialog box. Allows you to specify macro substitutions (for example, %name% displays the name of the associated control element)
Font height	Height of the font
Esc	Label for the cancel key. By the button located nearby, the button image is specified
Button	Specifies the key for an additional button
Close	Label of the button

To use dialog boxes in the properties of control elements on the mimic diagram, it is necessary to bind the dialog box to the right mouse button (figure 222).

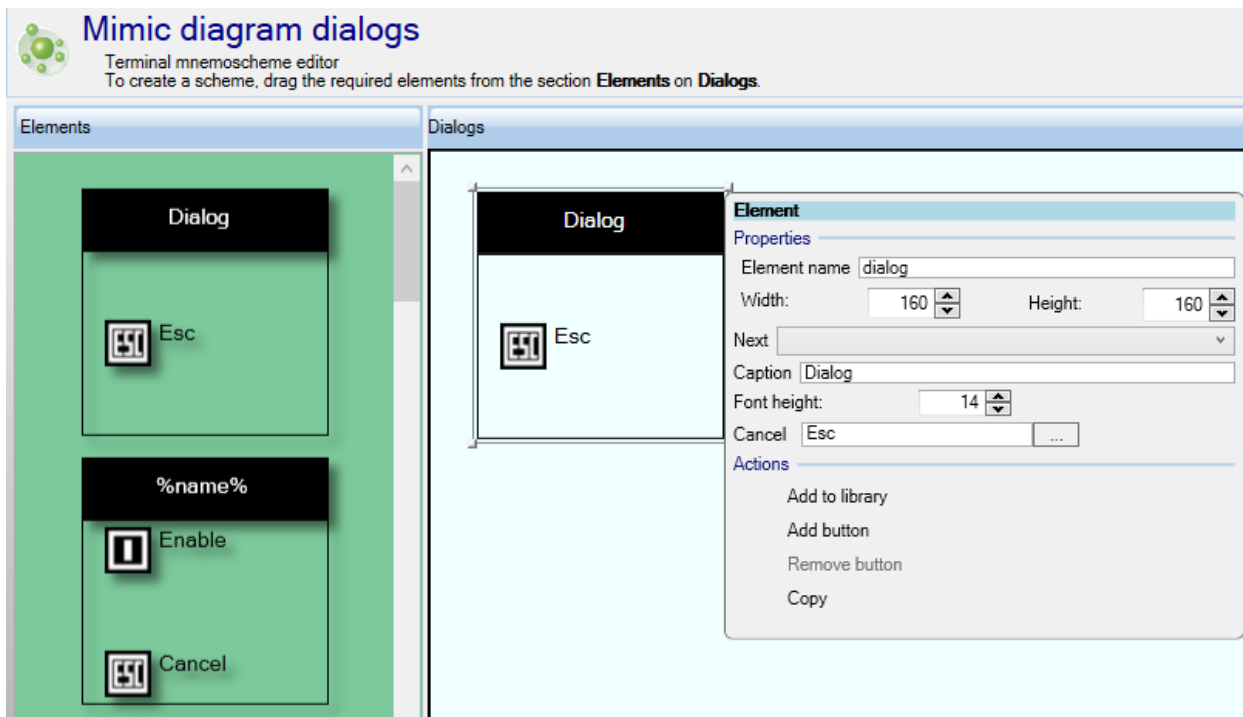

Figure 222

5.4.11 Control

5.4.11.1 Switching devices

The **Switching devices** window, device tree menu **Logic part** → **Control** → **Switching devices** (figures 223, 224, 225) is designed for viewing and editing the settings of switching devices.

#	Switch control name	Type	Position signaling	Communication interface	Program protocol	Control model	Resource calculation type
1	CB-1	Switch	Common	Ethernet 1	61850	direct-with-n...	Switching
2	Switch control2	Switch	Common	Ethernet 1	61850	direct-with-n...	none
3	Switch control3	Switch	Common	Ethernet 1	61850	direct-with-n...	none
4	Switch control4	Switch	Common	Ethernet 1	61850	direct-with-n...	none

Figure 223 – **Switching devices** window

The description of switching devices is shown in table 132.

Table 132 – Description of columns of switching devices

Parameter	Function
No.	Number of the switching device
Name	Name of the switching device
Type	Types of switching devices: – Circuit-breaker; – Disconnecter
Position signaling	Subtypes of the switching device: – Single-phase; – Three-phase with a common drive
Communication interface	Interface of communication
Program protocol	Used program protocol
Control model	Type of the model for control of the switching device according to IEC 61850-8-1
Remaining life calculation type	Type of calculation of the service life: – Switching; – Mechanical; – None

Parameters		Resource	
Parameter		Источник	Value
State off		Logic signals table	365: CB opened position
State On			314: CB closed position
Management permission	Enable Off	Logic signals table	none
	Enable On		none
	Substitution sign (q.source)		none
Local control		Logic signals table	346: Local control
Off circuit		Block of virtual inputs	1: VInputSwitchControl:MMS_Cmd_Open_CB-1
On circuit			2: VInputSwitchControl:MMS_Cmd_Close_CB-1

Figure 224 – Parameters of switching devices

Parameters of switching devices are shown in table 133.

Table 133 – Parameters of switching devices

Parameter	Function
Parameter	Name of the parameter
Source	Source
Value	Tripping/closing state

Parameters Resource

Current: <none>

Breaker opening table

	Current, kA	Switch off count	Initial switch off count		
			phase A	phase B	phase C
	5.04	300000	0	0	0
	5.5999799...	250000	0	0	0
	7.2	150000	0	0	0
	7.99998	100000	0	0	0

Breaker closing table

	Current, kA	Switch on count	Initial switch on count		
			phase A	phase B	phase C
	5.04	300000	0	0	0
	160.00001...	0	0	0	0

Start resource calculation

Start: By control signal

phase	Start signal status off	Start signal status on
A	365: CB opened position	314: CB closed position
B	365: CB opened position	314: CB closed position
C	365: CB opened position	314: CB closed position

Levels of operation

Degree signaling	Phase A	Phase B	Phase C
Degree 1	75.00	75.00	75.00
Degree 2	50.00	50.00	50.00
Degree 3	25.00	25.00	25.00
Degree 4	0.00	0.00	0.00

Current hold time relative to start signals

When off, ms

When on, ms

Figure 225 – Service life of switching devices





Parameters of the remaining life of switching devices are shown in table 134.

Table 134 – Parameters of the remaining life of switching devices

Parameter	Function
Current	Selection of the current circuit based on the control of which the remaining life of the switching device will be calculated
Openings table	
Current, kA	Specified openings current
Quantity of openings	Specified quantity of openings at a given openings current
Initial quantity of openings	Quantity of initial openings of each phase
Closings table	
Current, kA	Specified closing current
Quantity of closings	Specified quantity of closings at a given closing current
Initial quantity of closings	Quantity of initial closings of each phase
Remaining life calculation start	
Remaining life calculation start	Start of remaining life calculation: – By control signal; – By change of position
Phase	Phase A, phase B, phase C
Start signal at opening	Signal upon supply of which the remaining life will be calculated when opened
Start signal at closing	Signal upon supply of which the remaining life will be calculated when closed
Current hold time relative to start signals	
At opening, ms	Time from the moment the circuit-breaker is tripped until the device receives the signal of the opened position of contacts
At closing, ms	Time from the moment the circuit-breaker is closed until the device receives the signal of the closed position of contacts

Commands of the switching device panel are shown in table 135.

Table 135 – Toolbar commands

Icon	Command
	Add
	Delete
	Move up
	Move down

5.4.11.2 Electronic switches

The **Electronic switches** window, device tree menu **Logic part** → **Control** → **Electronic switches** (figure 226) is designed to configure electronic switches.

Number	Name	First time state	Active state desc.	Passive state desc.
1	Control mode local	<input type="radio"/>	local	remote
2	PButton shift S1	<input type="radio"/>		
3	PButton S2	<input type="radio"/>		
4	PButton shift S2	<input type="radio"/>		
5	PButton S3	<input type="radio"/>		
6	PButton shift S3	<input type="radio"/>		
7	PButton S4	<input type="radio"/>		
8	PButton shift S4	<input type="radio"/>		
9	PButton S5	<input type="radio"/>		
10	PButton shift S5	<input type="radio"/>		
11	PButton S6	<input type="radio"/>		
12	PButton shift S6	<input type="radio"/>		

Figure 226 – **Electronic switches** window

The description of window columns is given in table 136.

Table 136 – Description of columns of the **Electronic switches** window

Parameter	Function
Number	Number of the electronic switch according to the list
Name	Name of the electronic switch
Status at first start	Value of the electronic switch at the first start of the IED
Active status	Active state of the electronic switch
Inactive status	Inactive state of the electronic switch

5.4.11.3 Administration of management

The **Administration of management** window, device tree menu **Logic part** → **Control** → **Administration of management** (figure 227) , is designed for adding/deleting IP addresses.

Number	IP address	Name	Control level
1	127.0.0.1		Dispatching

Figure 227 – **Administration of management** window

The description of window columns is given in table 137.

Table 137 – Description of columns of the **Administration of management** window

Parameter	Function
Number	Sequence number of the IP address
IP address	IP address of the computer
Name	Name of the element
Control level	Level of control: – Dispatching; – Station

5.4.12 Differences by setting groups

The **Differences by setting groups** window, device tree menu **Logic part** → **Differences by setting groups** (figure 228), is designed to display parameters that differ in various setting groups.

Parameter	Settings group 1 (active)	Settings group 2	Settings group 3	Settings group 4	Units	Description
Protects: 3!(Tamb)>1cr_1						
Protection entered	<input checked="" type="checkbox"/>	<input checked="" type="checkbox"/>	<input checked="" type="checkbox"/>	<input checked="" type="checkbox"/>		
I(1)	2	2	2	2	o.e.	
T(1)	-40	-40	-40	-40	deg C	
I(2)	1.9	1.9	1.9	1.9	o.e.	
T(2)	-30	-30	-30	-30	deg C	
I(3)	1.8	1.8	1.8	1.8	o.e.	
T(3)	-20	-20	-20	-20	deg C	
I(4)	1.7	1.7	1.7	1.7	o.e.	
T(4)	-10	-10	-10	-10	deg C	
I(5)	1.6	1.6	1.6	1.6	o.e.	
T(5)	0	0	0	0	deg C	
I(6)	1.5	1.5	1.5	1.5	o.e.	
T(6)	10	10	10	10	deg C	
I(7)	1.4	1.4	1.4	1.4	o.e.	
T(7)	20	20	20	20	deg C	
I(8)	1.3	1.3	1.3	1.3	o.e.	
T(8)	30	30	30	30	deg C	
I(9)	1.2	1.2	1.2	1.2	o.e.	
T(9)	40	40	40	40	deg C	
I_nonadpt	1.5	1.5	1.5	1.5	o.e.	
Kret	0.99	0.99	0.99	0.99		
K_TS	6.25	6.25	6.25	6.25		
I_0_TS	12	12	12	12	mA	
T_update	1	1	1	1	Minute	

Figure 228 – **Differences by setting groups** window

The description of window columns is given in table 138.



Table 138 – Description of columns of the **Differences by setting groups** window

Parameter	Function
Parameter	Name of the parameter
Settings group	Value of the setting
Units	Measurement unit of the parameter
Description	Description of the parameter

5.5 IEC 61850

This node is available, if the configuration has the IEC 61850 Ethernet protocol (see **Ethernet protocols** for details).

5.5.1 Outgoing GOOSE

The **Outgoing GOOSE** window, device tree menu **IEC61850** → **Outgoing GOOSE** (figure 229), is designed to configure outgoing GOOSE messages for IEC 61850. Adding outgoing GOOSE to the list is done by pressing button , and deleting by using button .

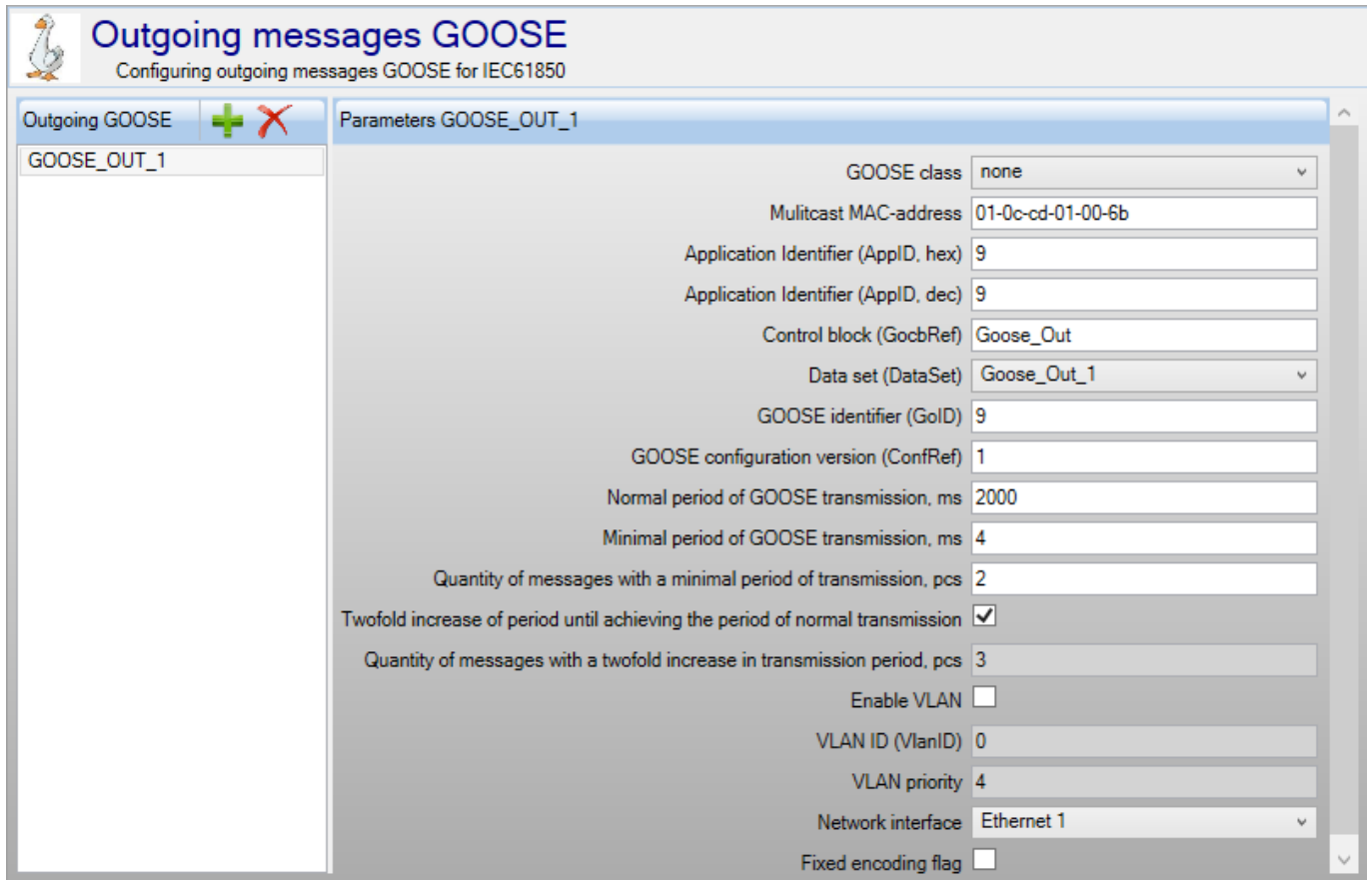

Figure 229 – **Outgoing GOOSE** window

Parameters of outgoing GOOSE messages are shown in table 139.

Table 139 – Parameters of outgoing GOOSE messages for IEC 61850

Parameter	Description
GOOSE message class	Class of the GOOSE message: – none; – I (Type 1A); – II (Type 1B); – III (Type 1B)
Multicast MAC address	Broadcast address to which GOOSE will be sent
Application identifier (AppID, hex)	Identifier of the application that uses a multicast (hexadecimal presentation)
Application identifier (AppID, dec)	Identifier of the application that uses a multicast (decima presentation: numeric value, recommended value is 16383)

Parameter	Description
Control block (GoCBRef)	Name of the control block responsible for the GOOSE multicast (recommended value is Goose_Out)
Data set (DataSet)	Name of the data set transmitted via GOOSE
ID GOOSE (GoID)	Identifier of the device that transmits the GOOSE packet to the general multicast (recommended value is ekraN, where N = (1,2,3...))
GOOSE configuration version (ConfRef)	Number of the current version of GOOSE configuration
Standard period for GOOSE transmission, ms	Time intervals (in milliseconds) between the transmission of GOOSE messages in the absence of signal changes. Periodic sending is used to control the presence of communication. Permissible value range is 100 to 65,000 ms
Minimal period for GOOSE transmission, ms	Minimum period of cyclic sending in the absence of signal changes. Permissible value range is 4 to 10,000 ms
Quantity of messages with a minimal period for transmission, pcs	Quantity of messages with a minimum transmission period. Permissible value range is 2 to 10
Doubled period until period standard transmission	If the box is checked, the transmission period is doubled until it reaches the standard sending period. If the box is not checked, the transmission period is doubled for the number of messages specified in the "Quantity of messages with a doubled period transmission" parameter, after which the transmission period is immediately taken equal to the standard
Quantity of messages with a doubled period transmission, pcs	Quantity of messages with a doubled transmission period. Permissible value range is 1 to 10
Enable VLAN	Enabling the use of VLAN in outgoing GOOSE messages
ID VLAN (VlanID)	Integer value, which is used in VLAN for identification
VLAN priority	Integer priority value for outgoing GOOSE messages using VLAN
Network interface	Ethernet interface, through which GOOSE message is sent
Fixed coding checkbox	Enables fixed coding mode for GOOSE packets

5.5.2 Incoming GOOSE

The **Incoming GOOSE** window, device tree menu **IEC61850** → **Incoming GOOSE** (figure 230), is for configuring incoming GOOSE messages for IEC 61850.

It consists of two components: list of incoming GOOSE and parameters of the selected GOOSE.

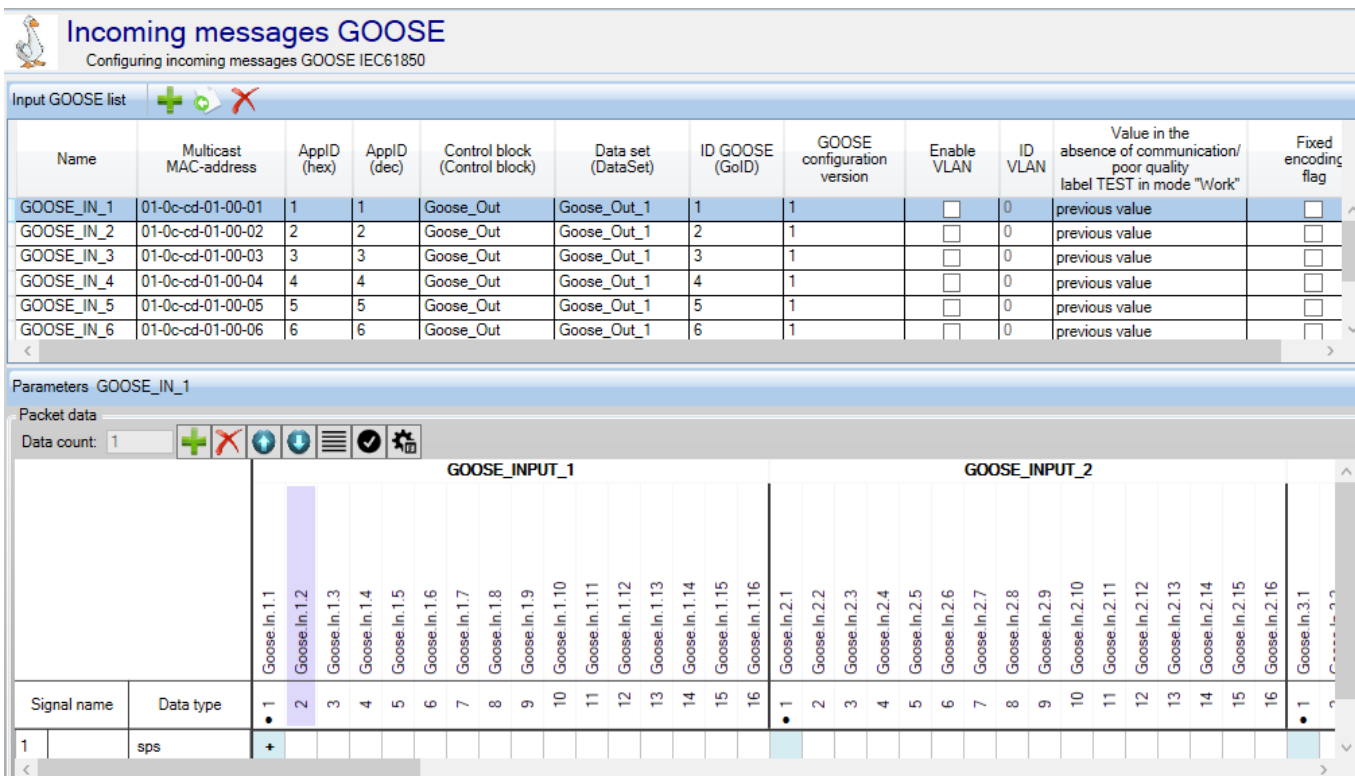

Figure 230 – Incoming GOOSE window

GOOSE_INPUT_1, GOOSE_INPUT_2 are virtual input modules for receiving GOOSE messages, which are added in the **Modules** tab.



An incoming GOOSE is added to the list by pressing button , and deleted by using button . Parameters of the incoming GOOSE packet are shown in table 140.

Table 140 – Parameters of the incoming GOOSE packet

Parameter	Description
Name	Name of incoming GOOSE messages
Multicast MAC address	Broadcast receiving address
AppID (hex)	Identifier of the application that uses a multicast (hexadecimal representation)
AppID (dec)	Identifier of the application that uses a multicast (decimal representation)
Control block	Name of the control block responsible for GOOSE multicast
Data set (DataSet)	Name of the data set transmitted via GOOSE
ID GOOSE (GoID)	Device identifier from which GOOSE must be received
GOOSE configuration version	Version of the GOOSE configuration on the device from which we receive a signal
Enable VLAN	Enabling the use of VLAN in incoming GOOSE messages
ID VLAN	Integer value, which is used in VLAN for identification
Value for no connection / bad quality / TEST label in non-TEST mode	Value to which the signal is set when there is no connection (GOOSE packets are not received) or when the data quality is poor (invalid, failure)
Fixed coding checkbox	Enables fixed coding mode for GOOSE packets

The packet parameters also include generation of packet data. The quantity of data objects in the packet is specified in the **Data count** item. Data objects can be of the following types:

- none (no data);
- bool (logical type, assigned to virtual inputs via data index);
- int (integer value);
- bitstring (string value);
- bitstring2 (two-bit value);
- float (data type with floating point);
- quality (data quality);
- timestamp;
- sps (structure, which contains a logical type, data quality and a time stamp).

5.5.3 Data sets

The **Data sets** window, device tree menu **IEC61850** → **Data sets** (figure 231), allows you to specify several data sets with various binary and analog signals, which can then be used for transmission on the **Report blocks** form.

The form allows you to configure the IEC 61850 data sets. The main components of the form are the list of data sets and parameters of the selected data set.

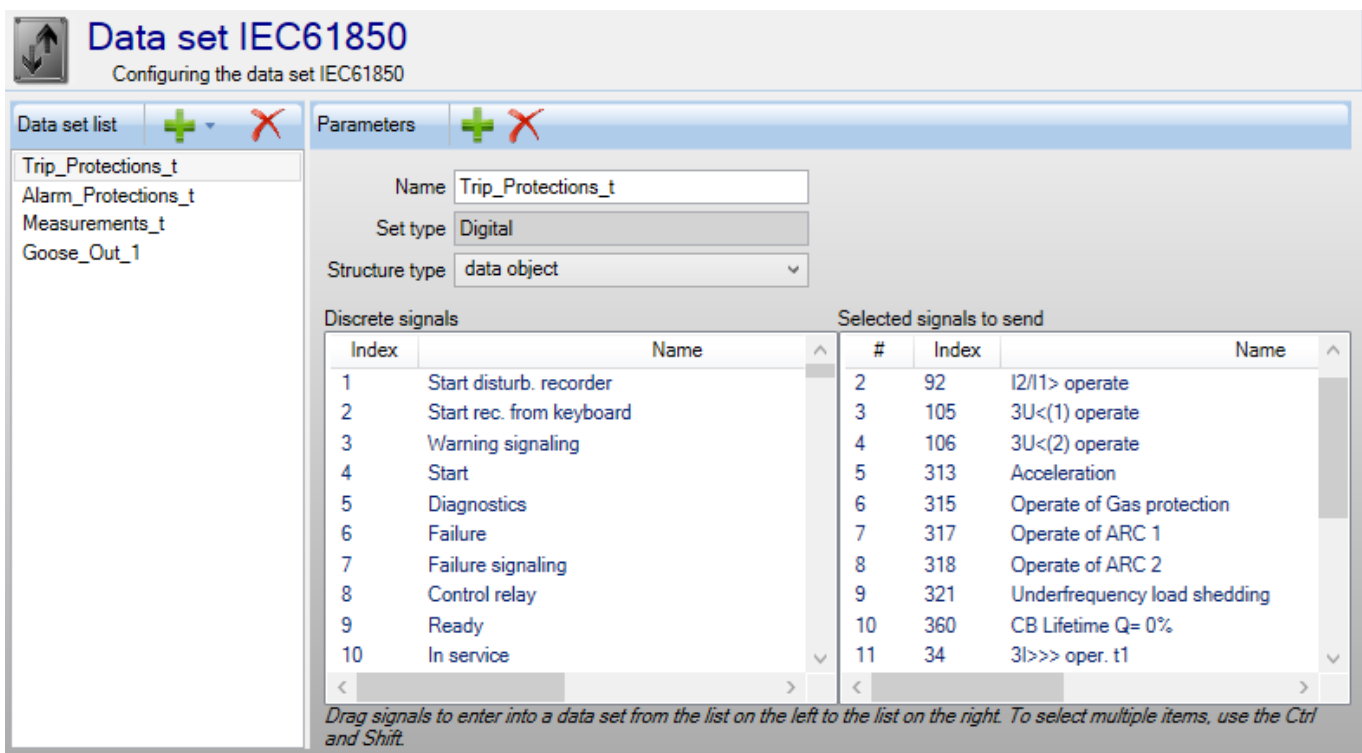





Figure 231 – **Data sets** window

Adding a new data set to the list is done by pressing button , and deleting by using button .

The type of data set is selected when adding it by pressing button .

Parameters of the data set consist of a name, a set type and a structure type.

To select signals for transmission, you need to drag the signals from the left list to the right one.

5.5.4 Report blocks

The **Report blocks** window, device tree menu **IEC61850** → **Report blocks** (figure 232), is designed for configuring the IEC 61850 report blocks. It consists of two components: a list of report blocks and parameters.

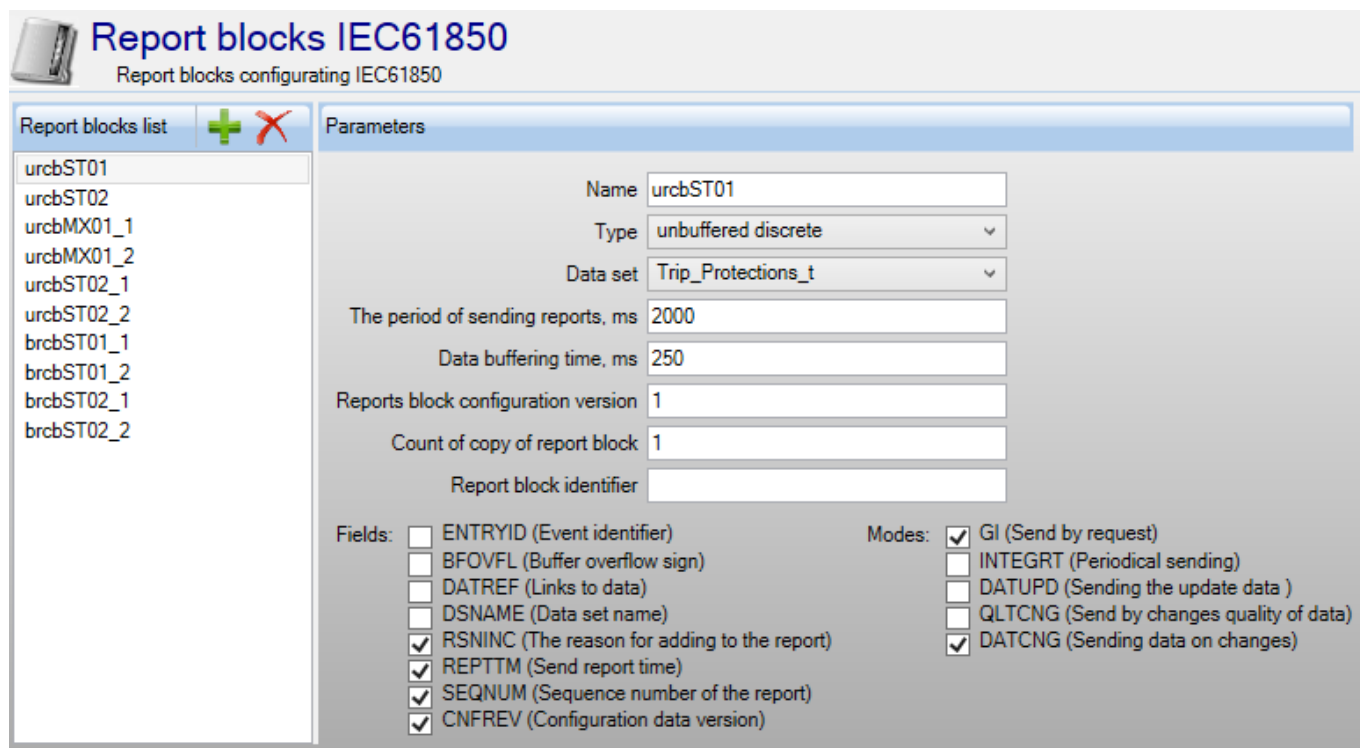

Figure 232 – Report blocks window

Parameters of the report are shown in table 141.

Table 141 – Parameters of the report

Parameter	Description
Name	Identifier of the report block (only available under IEC 61850)
Type (Unbuffered binary) (Buffered binary) (Unbuffered analog) (Buffered analog) (Unbuffered service) (Buffered service) (Unbuffered mixed) (Buffered mixed)	Unbuffered – in the absence of connection, the transmitted data is lost Buffered – during the time of connection failure, data is accumulated, when communication is restored, data is transmitted
Data set	Link to the data set created in menu item Data sets
Report send period, ms	Time of periodic sending of current values in milliseconds
Data buffering time, ms	Time of data collection before sending in milliseconds
Report block configuration version	Setting and displaying the version of report block configuration
Quantity of copies of report block	Quantity of identical report blocks, integer in the range of 1 to 60
Report block identifier	Text designation of the data report block

The list of fields (to choose from) that are transmitted in the report is given in table 142.

Table 142 – List of transmitted fields

Field	Description
ENTRYID	Entry identifier
BFOVFL	Buffer overflow sign
DATREF	Data reference
DSNAME	Data set name
RSNINC	Reason for including to report
REPTTM	Report transmission time
SEQNUM	Sequence number
CNFREV	Configuration revision

The list of transmission modes is given in table 143.

Table 143 – List of transmission modes

Mode	Description
GI	General interrogation
INTEGRT	Periodic transmission
DATUPD	Sending data updates
QLTCNG	Sending on data quality changes
DATCNG	Sending on data changes

5.5.5 Data model

The **Data model** window, device tree menu **IEC61850** → **Data model** (figure 233), allows the user to add new and edit existing logical nodes of the 61850 data model and bind binary signals to them.

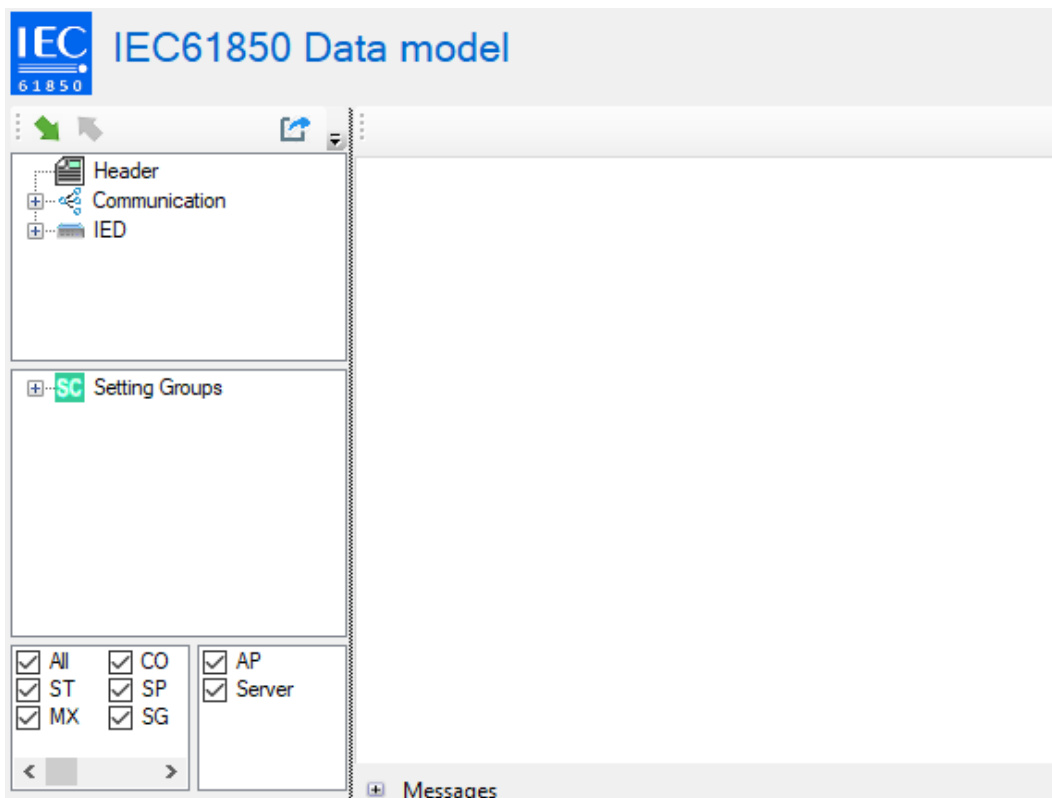

Figure 233 – **Data model** window

5.6 Modbus client

The Modbus client here means configuring the device for reading data (both analog and binary) using the Modbus RTU or Modbus TCP protocol via serial or network communication interfaces from another similar device. Typically, this function is used when configuring bay controllers.

Let's focus on the configuration process. In order to configure Modbus clients, the Modbus client protocol must be added in the **Hardware** → **System parameters** window in the **Ethernet protocols** tab or in the **Serial protocols** tab, otherwise this menu item is missing.

After adding the Modbus client protocol, a new node will be added to the project tree Modbus client (figure 234).

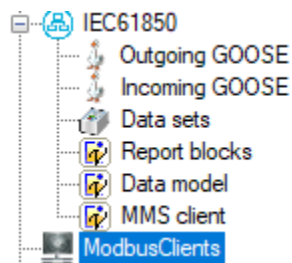

Figure 234 – **Modbus client** tab in the device tree

To edit settings of Modbus clients, open the **Modbus client** window (see figure 235).

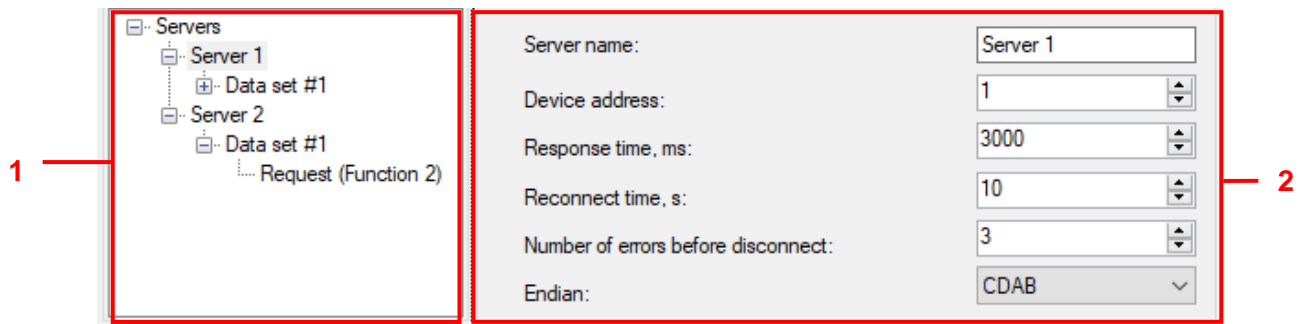

Figure 235 – Modbus client window

The window is divided into two areas. In figure 235, item 1 the hierarchical structure of requests of Modbus clients is shown, and in figure 235, item 2 – parameters of the selected node in the hierarchy. The hierarchical structure is represented as a tree and consists of four levels:

- a) Servers – contains a list of interrogated servers via Modbus client protocol;
- b) Server – interrogated device;

A new server can be added or deleted via context menu of the tree.

Server parameters are specified in table 144.

Table 144 – Server parameters

Parameter	Description
Server name	Name of the interrogated device
Device address	Address of the interrogated device
Response wait time, ms	Time to wait for a response from the device to a request in milliseconds
Reconnect time, s	Period of reconnection to the device when the connection is broken in seconds
Q-ty of errors before disconnect	Quantity of consecutive erroneous requests, after which the connection to the device is broken
Endian	Byte order in the memory map (0 – little endian, 1 – big endian)

c) Data set – logically grouped data obtained when interrogating devices. When a data set is selected, parameters of the data set are displayed in the right part of the window (figure 236). A data set can be added or deleted via context menu of the tree;

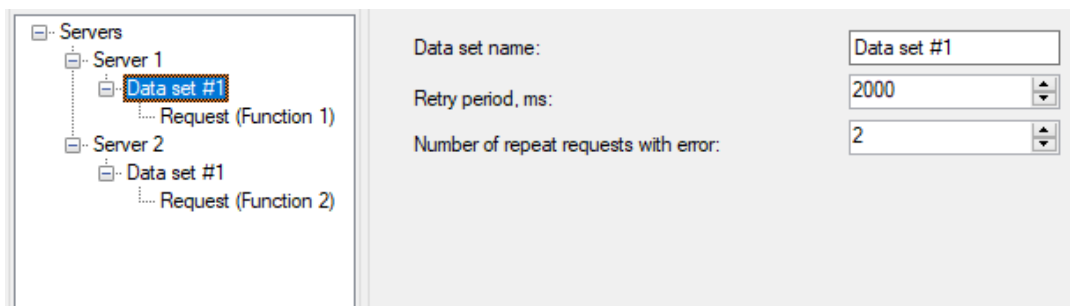

Figure 236 – Data set

Parameters of the data set are shown in table 145.

Table 145 – Parameters of the data set

Parameter	Description
Data set name	Name of the data set
Retry period, ms	Period of device interrogation in seconds
Q-ty of repeat requests in case of error	Quantity of request retries in case of error

d) Requests are Modbus protocol functions that are performed when interrogating devices. Requests are added and deleted through the context menu of the tree (figure 237).

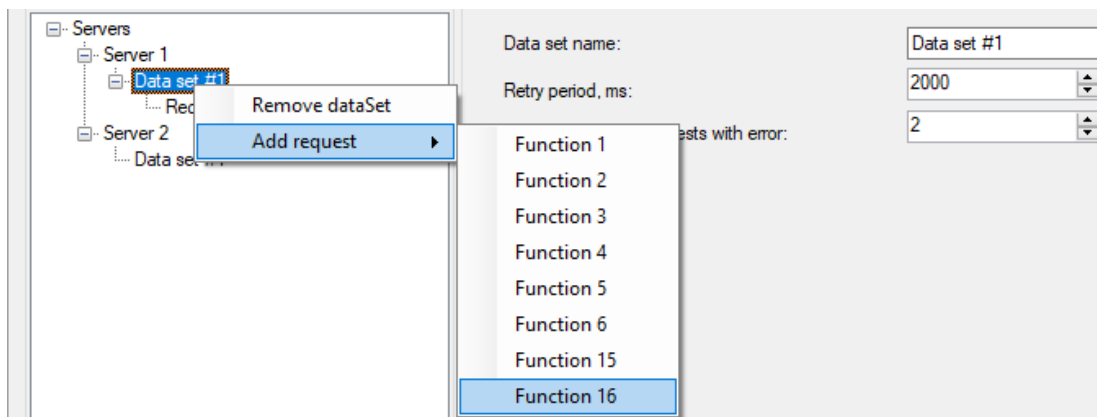

Figure 237 – Requests

Each request can consist of several data elements, which are added and deleted using corresponding buttons (figure 238).

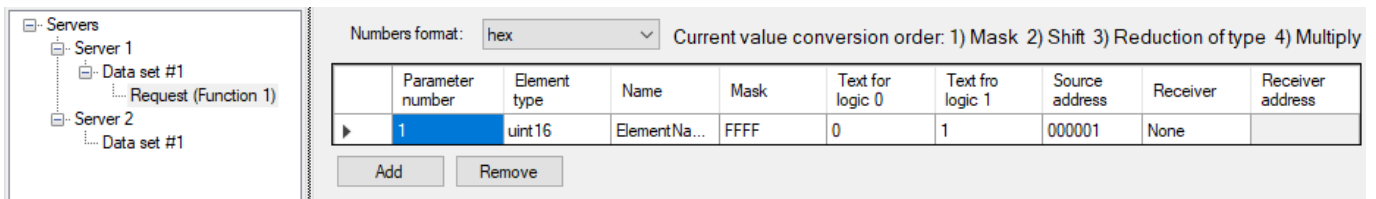

Figure 238 – Data elements

Each request element consists of several parameters. Numbers can be displayed in two formats:

- hex – hexadecimal number format;
- dec – decimal number format.

Parameters of data elements in the request are show in table 146.

Table 146 – Parameters of data elements in the request

Parameter name	Description
Parameter number	Direct number of the data element. Represents a service field that is required when setting formulas in calculated values
Element type	It specifies the type of the data element. There can be several types: <ul style="list-style-type: none"> – bit; – bit in register; – DPI; – int8; – int16; – int32; – int64; – uint8; – uint16; – uint32; – uint64; – float32; – double64
Name	Name of the data element
Mask	Mask of the data received from the interrogated device
Text for logical 0	For functions 3 and 4 it sets an offset. For other functions it will be a text value for logical 0
Text for logical 1	For functions 3 and 4 it sets a multiplier. For other functions it will be a text value for logical 1
Source address	Source address on the interrogated device
Receiver	Receiver type. There are several types: binary module; memory card If you do not specify the type of receiver, then the data is not saved anywhere. There is a special type of VinputModbus binary module – it is used to display data received via the Modbus client protocol
Receiver address	It specifies the receiver address. For the binary module it is the module number, and for the memory map it is the address in the IED's memory card

5.7 Calculated values

The **Calculated values** window (figures 239 – 241) is designed to create a list of measurements that are the result of calculations on IED signals. The calculated values are available for viewing through the IED menu, and they can also be placed on the mimic diagram.

Update period, ms

+ X ↑ ↓

Calculated values

Num	Name	Measure unit	Formula
1	I A	A	$F2(V1) \cdot ktV1$
2	I B	A	$F2(V2) \cdot ktV2$
3	I C	A	$F2(V3) \cdot ktV3$
4	U H-K	V	$F2(V10)$
5	Q1	logic	$2 \cdot IMOS("CB_CLOSED") + IMOS("VI1.5_CB_OPENED")$
6	UI	kV	$\sqrt{F2(V5) \cdot ktV5 \cdot F2(V5) \cdot ktV5 + F2(V6) \cdot ktV6 \cdot F2(V6) \cdot ktV6 - 2 \cdot F2(V5) \cdot ktV5 \cdot F2(V6) \cdot ktV6 \cdot \cos(F4(V6) - F4(V5))} \cdot 0.001$
7	f	Hz	$f("1U \ Y \ A", 0)$
8	S	MVA	$SabcY("I \ Y", "U \ Y") \cdot ktV1 \cdot ktV5 \cdot 0.000001$
9	P	MW	$PabcY("I \ Y", "U \ Y") \cdot ktV1 \cdot ktV5 \cdot 0.000001$
10	Q	Mvar	$QabcY("I \ Y", "U \ Y") \cdot ktV1 \cdot ktV5 \cdot 0.000001$
11	Earth Switch	logic	$IMOS("VI3.13_ES_CLOSED")$

Figure 239 – Calculated values window

The continuation of the window is given in figure 240.

	Format		Display calculated value	Transfer to DSP	Oscillography	Editing in Free ver.	Use alarm and confidence thresholds	Alarm and confidence thresholds	
f	4.2	F	<input checked="" type="checkbox"/>	<input type="checkbox"/>	<input type="checkbox"/>	<input checked="" type="checkbox"/>	<input type="checkbox"/>	0; 0; 0; 0; 0; 0;	...
f	4.2	F	<input checked="" type="checkbox"/>	<input type="checkbox"/>	<input type="checkbox"/>	<input checked="" type="checkbox"/>	<input type="checkbox"/>	0; 0; 0; 0; 0; 0;	...
f	4.2	F	<input checked="" type="checkbox"/>	<input type="checkbox"/>	<input type="checkbox"/>	<input checked="" type="checkbox"/>	<input type="checkbox"/>	0; 0; 0; 0; 0; 0;	...
f	3.2	F	<input checked="" type="checkbox"/>	<input type="checkbox"/>	<input type="checkbox"/>	<input checked="" type="checkbox"/>	<input type="checkbox"/>	0; 0; 0; 0; 0; 0;	...
f		F	<input checked="" type="checkbox"/>	<input type="checkbox"/>	<input type="checkbox"/>	<input checked="" type="checkbox"/>	<input type="checkbox"/>	0; 0; 0; 0; 0; 0;	...
f	2.2	F	<input checked="" type="checkbox"/>	<input type="checkbox"/>	<input type="checkbox"/>	<input checked="" type="checkbox"/>	<input type="checkbox"/>	0; 0; 0; 0; 0; 0;	...
f	2.2	F	<input checked="" type="checkbox"/>	<input type="checkbox"/>	<input type="checkbox"/>	<input checked="" type="checkbox"/>	<input type="checkbox"/>	0; 0; 0; 0; 0; 0;	...
f	3.2	F	<input checked="" type="checkbox"/>	<input type="checkbox"/>	<input type="checkbox"/>	<input checked="" type="checkbox"/>	<input type="checkbox"/>	0; 0; 0; 0; 0; 0;	...
f	3.2	F	<input checked="" type="checkbox"/>	<input type="checkbox"/>	<input type="checkbox"/>	<input checked="" type="checkbox"/>	<input type="checkbox"/>	0; 0; 0; 0; 0; 0;	...
f	3.2	F	<input checked="" type="checkbox"/>	<input type="checkbox"/>	<input type="checkbox"/>	<input checked="" type="checkbox"/>	<input type="checkbox"/>	0; 0; 0; 0; 0; 0;	...
f	3.2	F	<input checked="" type="checkbox"/>	<input type="checkbox"/>	<input type="checkbox"/>	<input checked="" type="checkbox"/>	<input type="checkbox"/>	0; 0; 0; 0; 0; 0;	...

Figure 240 – Continuation of the Calculated values window

Parameters	
Parameter	Value
Smooth coefficient	1
Maximum value	6000
Deadband, % of max. value	5
Deadband, absolute value	300

Figure 241 – Parameters of calculated values

The list of calculated values and their description are given in table 147.

Table 147 – List of calculated values and their description

Parameter	Description
Number	Sequence number of the calculated value is entered automatically
Name	Name of the calculated value is specified
Meas. unit	It is required to select a measurement unit. Logic value is selected for binary signals
Formula	Formula is specified by which calculation will be carried out. Entered formulas are checked, in case of an error, the cell will be marked with  . A detailed guide on creating formulas can be received by pressing the Help button.
Format	<p>It is specified, in which format the value is displayed on the IED screen. Format string syntax (optional parameters in square brackets): <code> %[flags][width][.accuracy][size]type</code></p> <p>Flags: “-” – left alignment, “+” – always specify the character, “space” – place a space, if the first symbol is not a character, “0” – complement the field with zeros up to the width</p> <p>Width: (decimal number or a star symbol) specifies the minimum field width (including a character for numbers)</p> <p>Accuracy is set as a dot followed by a decimal number or an asterisk (*). If there is no number or asterisk (only a dot is present), then the number is assumed to be zero.</p> <p>Size field allows you to specify the size of the data.</p> <p>Type specifies not only the type of the value (from the point of view of the C programming language), but also the specific representation of the output value (for example, numbers can be displayed in decimal or hexadecimal form). Written as a single character. Unlike other fields, this field is required.</p> <p>Type values: d, i – decimal signed number; o – octal unsigned number; u – decimal unsigned number; x and X – hexadecimal number; f and F – floating point numbers. e and E – floating point numbers in the exponential record form (1.1e+44 type); e displays “e” character in the lowercase, E displays it in the uppercase (3.14E+0); g and G – floating point number; the representation form depends on a value (f or e); a and A – floating point number in hexadecimal form; Example: <code>%05.1f</code></p>
Display calculated value	Enabling display of the calculated value in the Smart Monitor software and in the IED menu
Transmit to FP	Enabling transmission of results to the functional processor. This parameter is available only for values with the logic type. When checking the box, this signal appears on the logic diagram
Disturbance recording	Enabling disturbance recording
Use alarm and validity thresholds	Enabling use of thresholds
Alarm and validity thresholds	Description of settings of the analog calculated value range
Parameter	Parameter of the calculated value
Value	Calculated value

5.7.1 Calculated values settings

The **Calculated values settings** window, device tree menu **Calculated values** → **Calculated values settings** (figure 242), is designed for editing the settings of calculated values.

Number	Name	Setting Group 1 (active)	Setting Group 2	Setting Group 3	Setting Group 4
1	Imax	5	5	5	5

Unit	Min. value	Max. value	Description (ru)	Description (en)
A	[] 0	20		

Figure 242 – **Calculated values settings** window



The settings of calculated values are added to the list by pressing button , and deleted by using button . The setting parameters of calculated values are shown in table 148.

Table 148 – Parameters of calculated values

Parameter	Description
Number	Number of the calculated value setting
Name	Name of the calculated value setting
Setting group 1	Setting of the calculated value
Unit	Measurement unit of the calculated value setting
Min. value	Minimum value of the calculated value setting
Max. value	Maximum value of the calculated value setting
Description (Ru)	Comment in Russian
Description (En)	Comment in English

* The quantity of columns depends on the quantity of setting groups in the configuration.

5.8 User data

The **User data** window (figure 243) is designed for adding user data.

Number	Group	Signal
1	FP status signals	1. Ready

Source data type	Destination type	Address	Name
bool	bool	6719	Ready

Figure 243 – **User data** window

The description of columns of the user data table is given in table 149.

Table 149 – Description of columns of the user data table

Column	Function
Number	Number of the user data element
Group	Group to which the user data element belongs
Signal	Signal based on which the user data element will be generated
Source data type	Type of the source signal data
Destination data type	Data type of the user data element
Address	Address of the user data element in the ModBus memory map
Name	Name of the user data element

5.9 103 Protocol Master

The 103 Protocol Master window is shown in figure 244.

The table of variables consists of two components: slave devices and parameters of IEC103Slave.

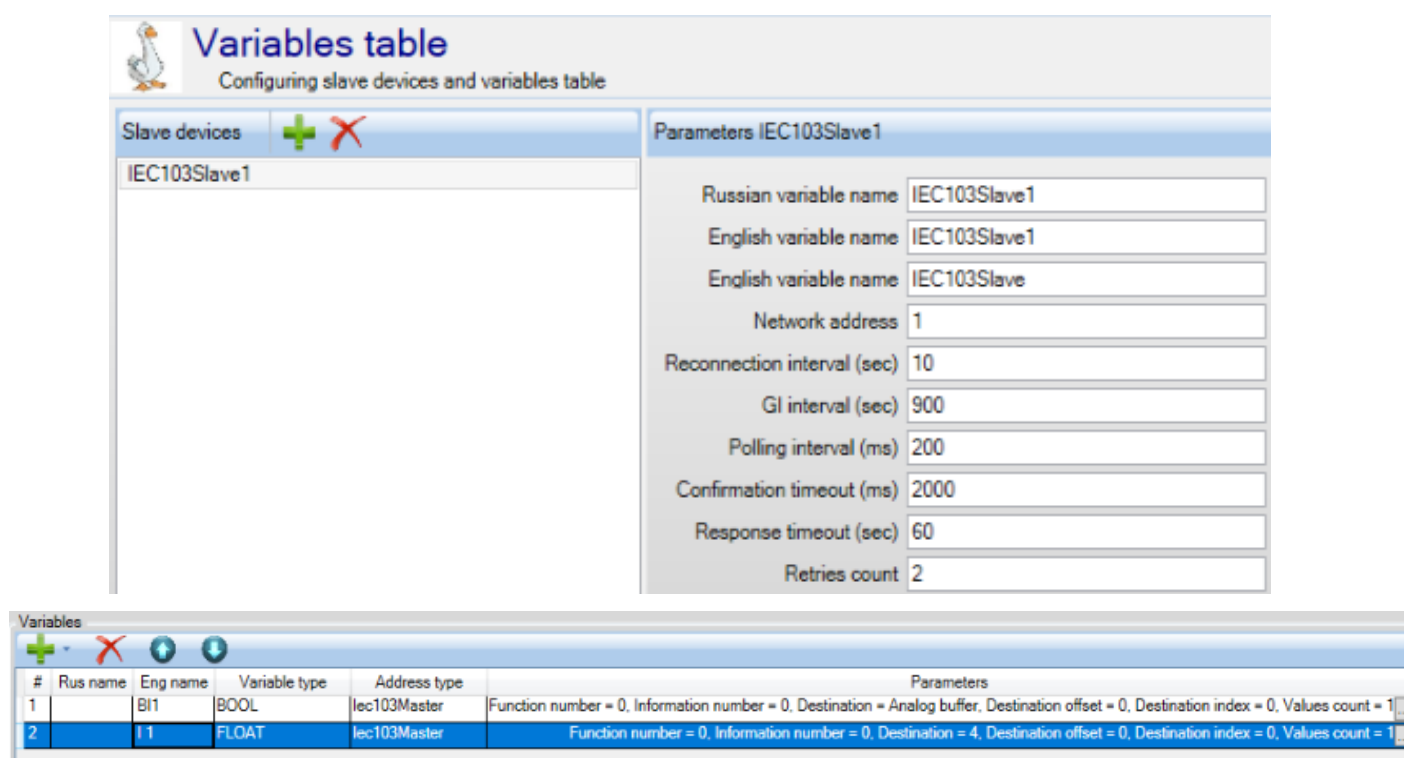

Figure 244 – 103 Protocol Master window

Note – The window is displayed if the IEC103Master protocol is available in menu item **System parameters** → **Serial protocols**.



The slave device and variables are added to the list by pressing button , and deleting by using button . Parameters of the slave device are shown in table 150.

Table 150 – Parameters of slave devices

Parameter	Description
Name in Russian	Slave device in Russian
Name in English	Slave device in English
Network address	Address of the slave device
Reconnect interval, s	Interval between reconnection commands in seconds
GI interval, s	Interval between general interrogation commands in seconds
Polling interval, ms	Interval between data requests in milliseconds
Confirmation timeout, ms	Maximum time to wait for confirmation in milliseconds
Response timeout, s	Maximum time to wait for a slave response in seconds
Retry count	Maximum quantity of connection retries

Parameters of variables are shown in table 151.

Table 151 – Parameters of variables

Parameter	Description
#	Sequence number of the variable for the current device
Ru name	Russian name of the slave device
En name	English name of the slave device
Variable type	Variable type of the slave device
Address type	Address type of the slave device
Parameters	Parameters of the slave device

5.10 Configuration parameters

The configuration parameters describe main parameters of the configuration file.

5.10.1 Versions

Description of versions of files and libraries (figure 245) included in the configuration:

- Configuration;
- Library;
- Dist. record file;
- Event recorder file;
- DSP program;
- Firmware;
- Program assembly.

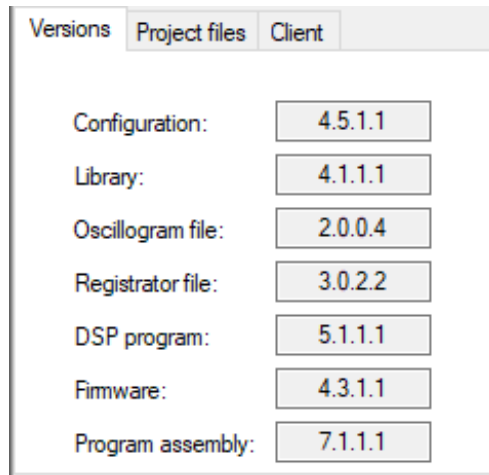

Figure 245 – **Versions** tab

5.10.2 Project files

The list of project files (figure 246) is given in table 152.

Table 152 – List of project files

File	Description
CZG file	File of the project configuration
Logic file	File of the project logic
Flexible logic file	File of the project flexible logic
IEC61850 model file	File of the project IEC61850 model

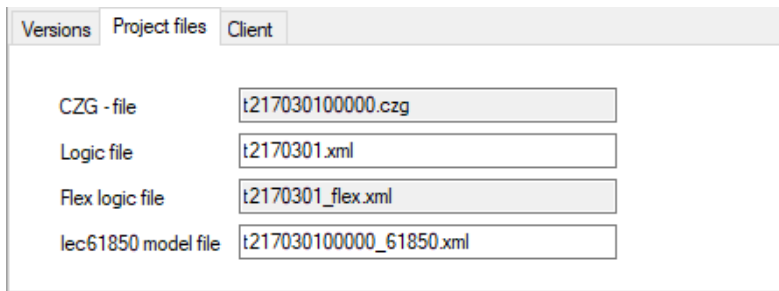

Figure 246 – **Project files** tab

5.10.3 Customer

Common

Object electric energy industry

Protected object

Cabinet name

Cabinet serial number

Terminal name

Terminal serial number

Kit

Functional scheme version

Commentary to version FS on RU

Commentary to version FS on EN

Configuration version

Hardware configuration

Program assembly:

Protected objects

Name
*

Protected subobjects

Number	Name	Short name
*		

Project files

CZG - file

Logic file

Flex logic file

Iec61850 model file

Figure 247 – Customer tab

Main parameters in the **Customer** tab (figure 247) are shown in table 153.

Table 153 – Customer

Name	Description
Client	Object electric energy industry Protected object Cabinet name Cabinet serial number IED name IED serial number Set Functional diagram version Comments to FD in Ru Comments to FD in En Configuration version Hardware configuration

Name	Description
Protected objects	List of protected objects
Protected subobjects	List of protected subobjects

5.11 Possible failures

5.11.1 Errors when opening the configuration in the Configurator program

The main error when opening the configuration file – is opening a corrupted configuration file. If the configuration file is corrupted or has an unsupported version, the following message will be displayed: “Error in the application. CZG version is not supported!”. In addition, there may be an error within the configuration, which will be reported in the **Errors in configuration** tab (figure 248).

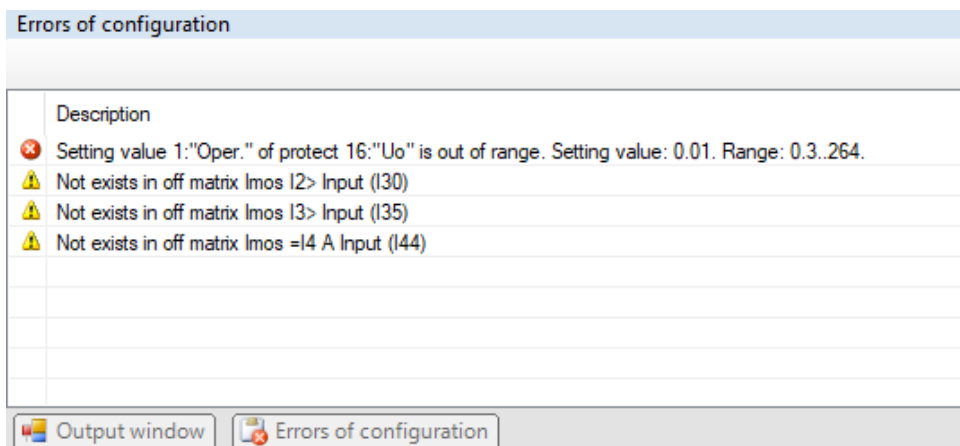

Figure 248 – Errors in configuration

5.11.2 Errors when working with logic in the Configurator program

Before starting or compiling the logic, make sure that all logic outputs are connected or disconnected. Otherwise, a message will be displayed at start: “Logic compilation failed. Your logic diagram has unused outputs! Disable or connect them” (figure 249). Next, a list of unconnected outputs will be offered with the option to disable them (figure 250).

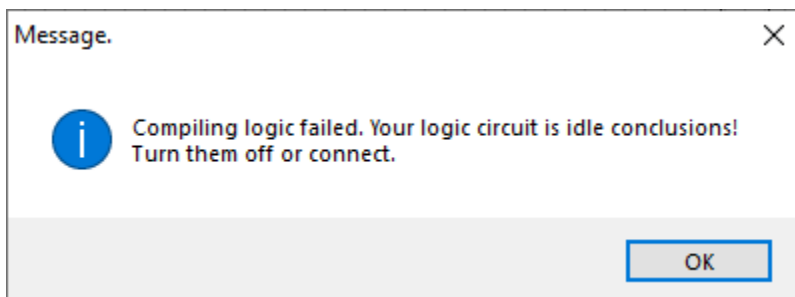

Figure 249 – Message about failure to compile logic

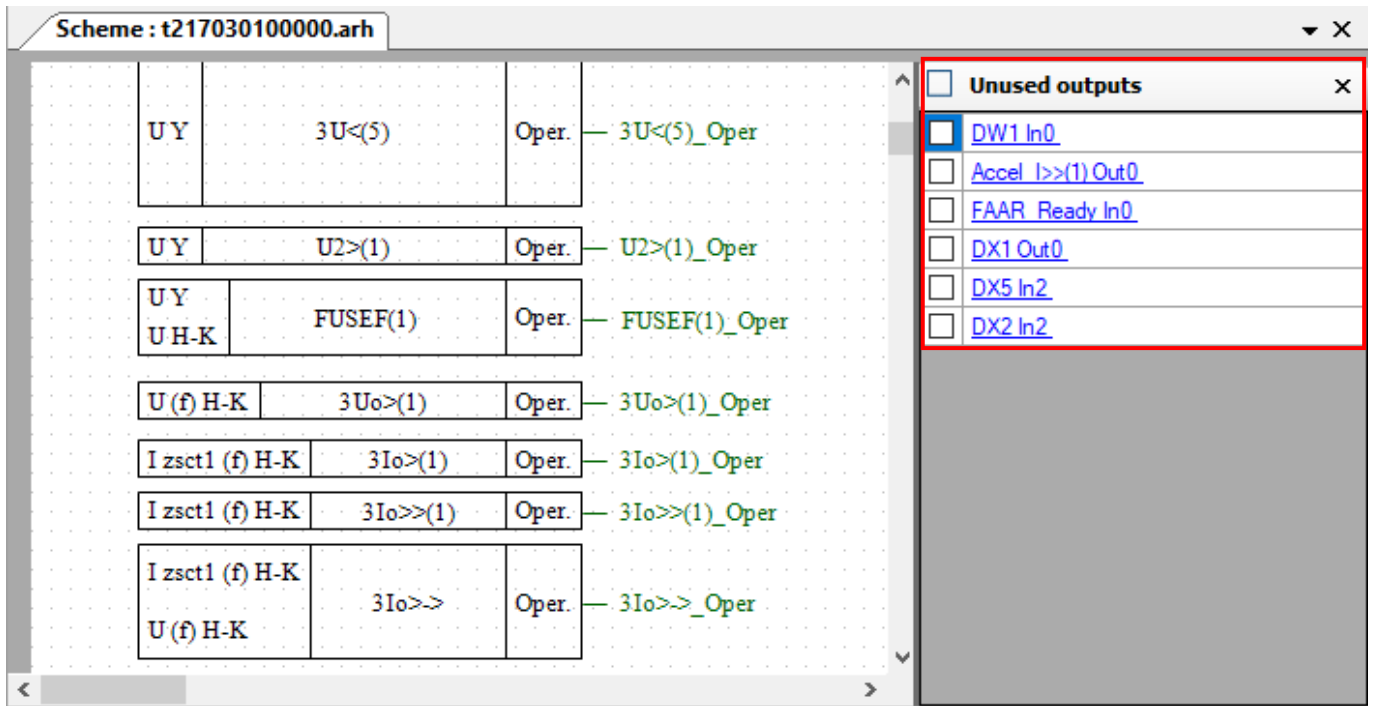



Figure 250 – Unused outputs in the logic

6 Description of Health Monitor interface

5.1 Start

The program is started via the PC **Start** menu.

5.2 Program shutdown

Closing the program with the ALT+F4 key combination or by clicking  on the title bar of the main window minimizes the program to the system tray by default. To completely close the program, you need to open the system tray, move the cursor over the program and open the context menu by clicking the right mouse button. In order for the application to be closed using the above actions, it is necessary to check the box “Shutdown program when closing window” in the **General** tab in the program settings.

5.3 General view

The standard window of the Health Monitor program includes the following:

- title containing the name and version of the program (figure 251, item 1);
- **Menu** (figure 251, item 2);
- **IED states** (figure 251, item 3);
- **Event log** (figure 251, item 4).

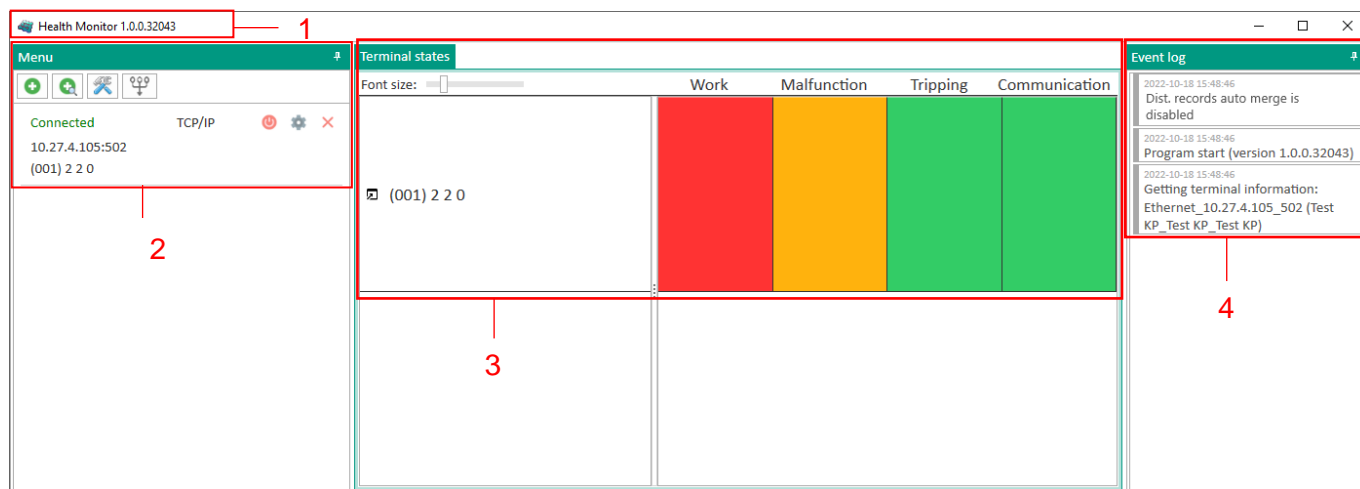





Figure 251 – Standard Health Monitor window

The **Menu** tab contains a tree of objects designed for viewing and editing the list of connected devices.

The **IED statuses** tab displays a list of connected devices. The device status bar displays device state indicators: **In servise**, **Error**, **Operate** and **Connection**. Possible states of indicators:

-  “green” – normal (operational) state; the indicator is green;
-  “red” – emergency state; the indicator is red;
-  “orange” – warning failure; the indicator is orange;
-  “grey” – undefined state; the indicator is grey.

Available states of indicators are given in table 154.

Table 154 – States of indicators

Indicator	Indicator color	Description
Operation	Green	Normal operation mode of the IED. No failure. The IED is in the “Operation (On)” mode
	Red	Emergency failure of the IED or the IED is in a mode other than the “Operation (On)” mode
	Grey	Connection to the IED is not available
Error	Green	Normal operation mode of the IED. No failure
	Red	Emergency failure of the IED. Requires immediate intervention to disable the IED and troubleshooting. In this case, the IED does not perform the intended functions or performs them in a limited amount in accordance with the functional diagram
	Orange	Emergency failure of the IED. At the same time, the IED remains in operation, i.e. performs the assigned functions in accordance with the functional diagram. Further operation of the IED with troubleshooting is possible at any convenient time
	Grey	Connection to the IED not available
Operate	Green	No operate
	Red	There are signals that are configured for alarm
	Grey	Connection to the IED not available
Connection	Green	Informs about the available connection to the IED
	Red	Connection to the IED is not available. In this case, the first three indicators change color to grey

Examples of device states:

a) connection to the device is not available (figure 252);



Figure 252 – Connection to the device is not available

b) connection to the device is available; the device is in normal operation state (figure 253);

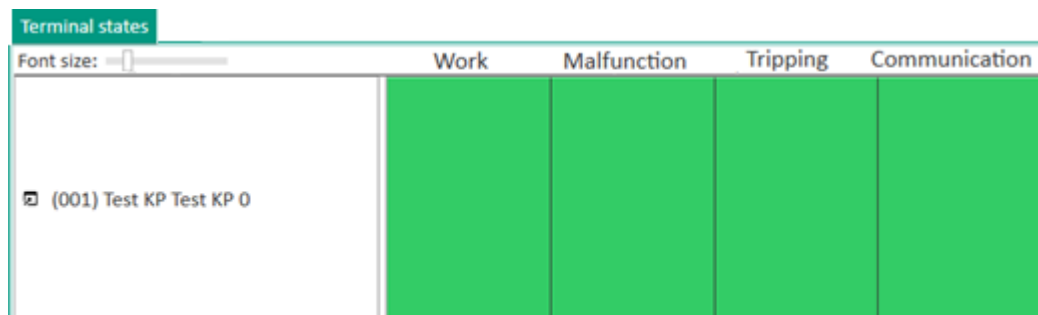

Figure 253 – Connection to the device is available

c) functions have operated or signals have appeared that affect the emergency alarm signal (figure 254);



Figure 254 – Operation of functions or appearance of signals

d) device is in non-operating state, not ready for operation and there is a failure (figure 255);



Figure 255 – Device is not ready for operation and there is a failure

e) device is in non-operating state, not ready for operation (figure 256).

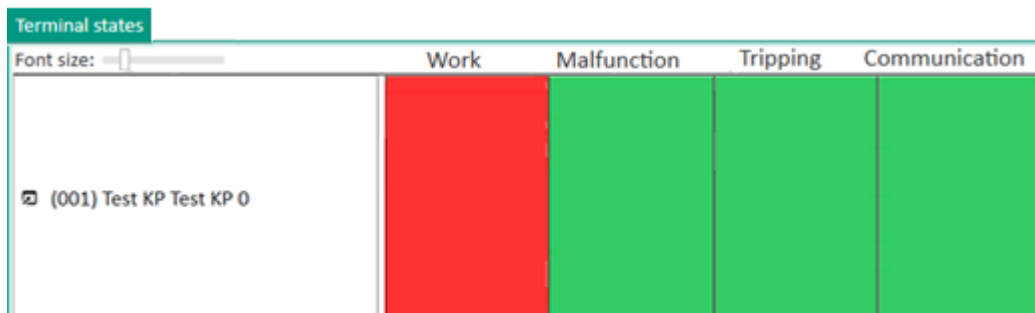

Figure 256 – Device is not ready for operation

If there is a connection to the device, you can start the Smart Monitor program by clicking on the button  (figure 257).



Figure 257 – Start of the Smart Monitor program

Also in the **IED statuses** tab, you can change the font size by moving the scale slider (figure 258).



Figure 258 – IED statuses tab

5.3.1 Toolbar

The toolbar of the **Menu** tab is given in figure 259.

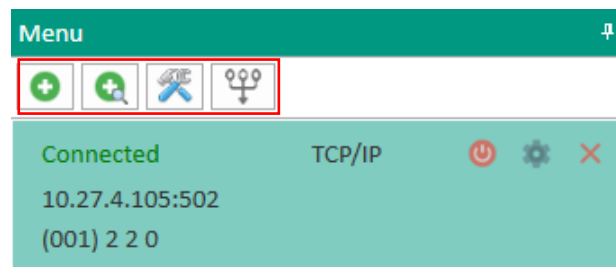







Figure 259 – Toolbar of the **Menu** tab

The description of the toolbar buttons is given in table 155.

Table 155 – Description of toolbar buttons

Button	Description
	Adding a connection
	Search for IEDs in the local network
	Program settings
	Manual merging

The description of the windows and tabs that are displayed when the button is clicked is given below.

1) Adding a connection .

The **General** tab is given in figure 260.

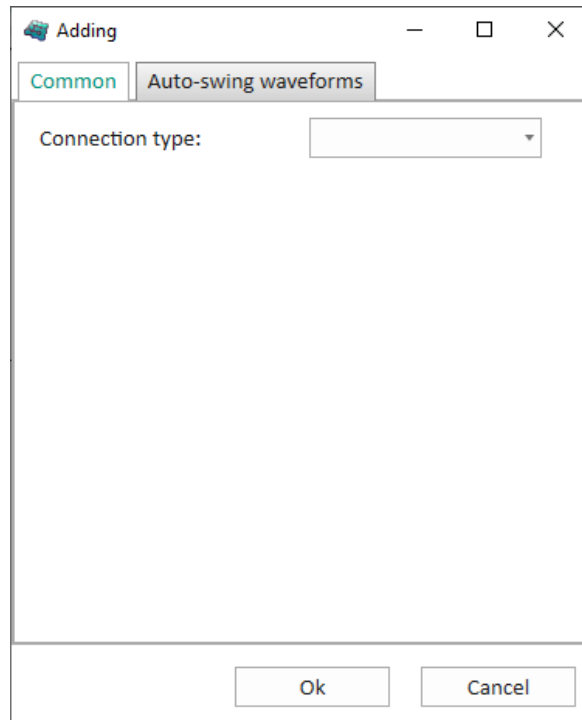

Figure 260 – Adding a connection

The description of parameters for adding a connection is given in table 156.

Table 156 – Description of parameters for adding a connection

Parameter	Description
Connection type:	- TCP/IP; - USB; - COM

Adding a TCP/IP connection (**General** tab) (figure 261).

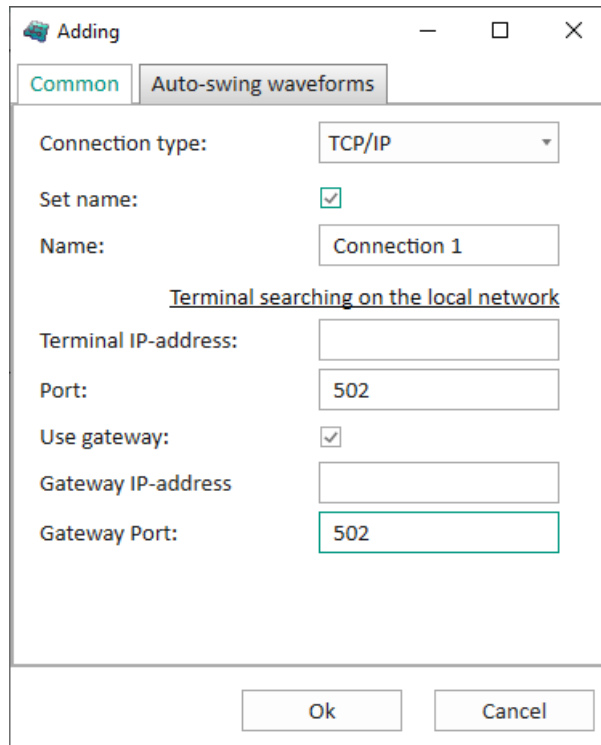

Figure 261 – Adding a TCP/IP connection

The description of window parameters is given in table 157.

Table 157 – Description of parameters for adding a TCP/IP connection

Parameter	Description
Set name:	Checked box allows you to set the name of the connection
Name:	Field for entering the name of the IED. The field is available after checking the “Set name” box
Search for IEDs in local network	Possibility to search for IEDs in the local network
IED IP address:	Field for entering the IP address of the IED manually
Port:	Connection port
Use gateway:	Checked box allows using the gateway
Gateway IP address:	Entering the gateway IP address manually
Gateway port:	Field for entering the connection gateway port

The window for IED search in the local network is given in figure 262.

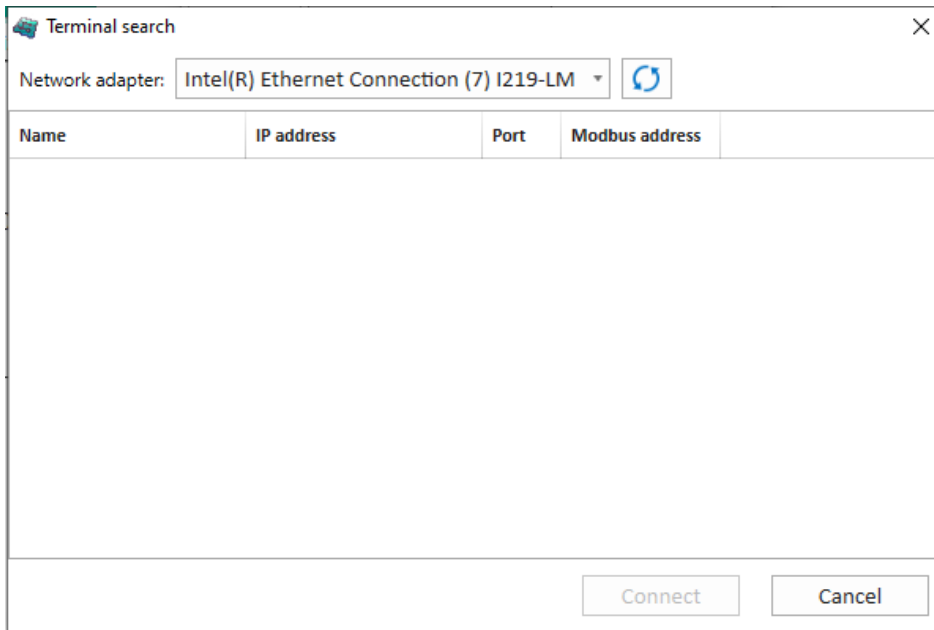

Figure 262 – IED search in local network

The description of search parameters for IEDs in the local network is given in table 158.

Table 158 – Description of search parameters for IEDs in the local network

Parameter	Description
Network adapter:	Selecting a network interface for automatic search for IEDs
Name	IED name
IP address	IP address of the IED
Port	Connection port
Modbus address	Modbus address of the IED

Adding a USB connection (**General** tab) (figure 263).

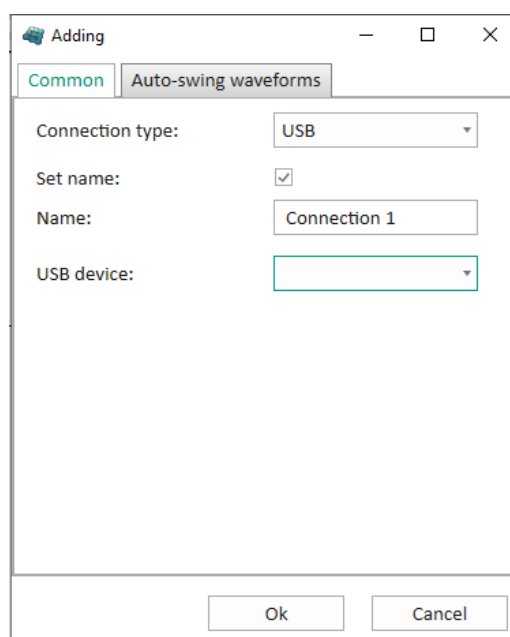

Figure 263 – Adding a USB connection

The description of window parameters is given in table 159.

Table 159 – Description of parameters for adding a USB connection

Parameter	Description
Set name:	Checked box allows you to set the name
Name:	Connection name
USB device:	Selecting the device for connection

Adding a COM connection (**General** tab) (figure 264).

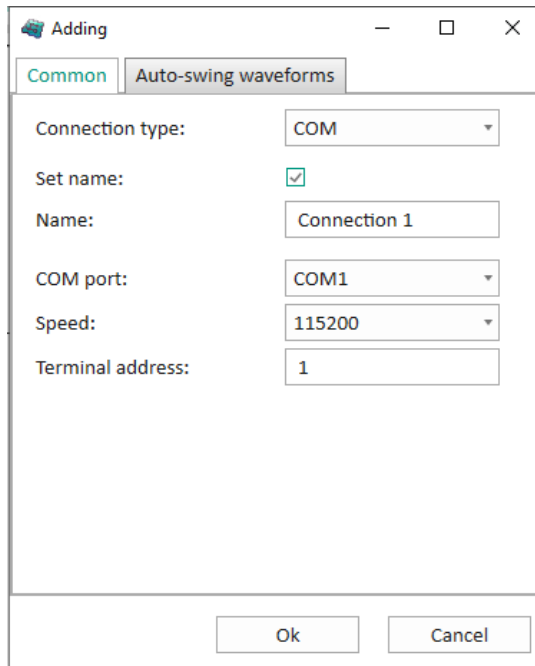

Figure 264 – Adding a COM connection

The description of window parameters is given in table 160.

Table 160 – Description of parameters for adding a COM connection

Parameter	Description
Set name:	Checked box allows you to set the name
Name:	Connection name
COM port:	Selecting the COM port
Speed	Selecting the COM port speed from the drop-down list (bps): <ul style="list-style-type: none"> - 110; - 300; - 1,200; - 2,400; - 4,800; - 9,600; - 19,200; - 38,400; - 57,600; - 115,200; - 230,400; - 460,800; - 921,600
IED address	Entering the Modbus address of the IED

To select the parameters for auto-download of disturbance records, go to the **Auto-download dist. records** tab and check the “Auto-download” box (figure 265).

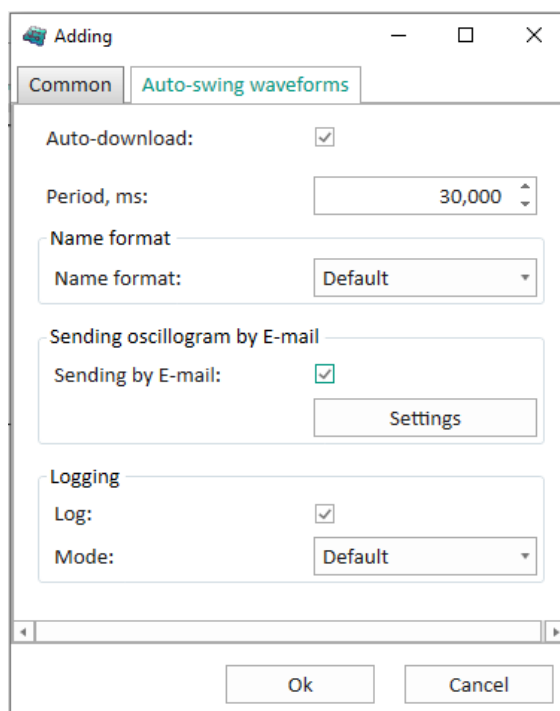

Figure 265 – **Auto-download dist. records** tab

The parameters of the **Auto-download dist. records** tab are given in table 161.

Table 161 – Parameters for auto-download of disturbance records

Parameter	Description
Auto-download	Checked box indicates automatic download of disturbance records
Period, ms:	Period of download of disturbance records
Name format	
Name format:	<p>– By default (the names of automatically downloaded disturbance record files will have the Oscil_oXXXX format, where <Oscil> is the name of the configuration file;</p> <p style="padding-left: 40px;"><XXXX> – sequence number of the disturbance record, the “_” symbol means space);</p> <p>Example – kp200 o0134;</p> <p>– Date, Time, Timecode, Object, Source, Subject (the names of automatically downloaded disturbance record files will have the format Date, Time, Timecode, Object, Source, Subject according to STO 59012820.29.020.006-2015, where <Object> (object of power industry) is the name of the substation or power plant, <Source> – name of ER, <Subject> (subject of power industry) – name of the legal entity. The date and time of generation of the disturbance record are added to the end of the name automatically). Example – 22.09.23, 23.06.30.000, 0t, CHP-3, GT-12;</p> <p>– Set manually (the name of the automatically downloaded file will have the format <Name>_<Date>_<Time>, where <Name> is the name of the disturbance record. The date and time of generation of the disturbance record are added automatically).</p> <p>Example – te1 23.08.2016. 10.28.24</p>

Parameter	Description
Sending disturbance records by E-mail	
Sending by E-mail:	Checked box indicates sending disturbance records by E-mail
Logging	
Write to log:	Checked box indicates writing to the log
Mode:	<ul style="list-style-type: none"> – Errors only (writes additional data to the log when errors occur); – By default (informs about the downloaded disturbance records: time of downloading the disturbance record, sending via mail); – Advanced (informs the download of the disturbance record in step-by-step mode: the beginning of downloading the disturbance record, conversion, all movements of disturbance records)

The **Mail client settings** window is given in figure 266.

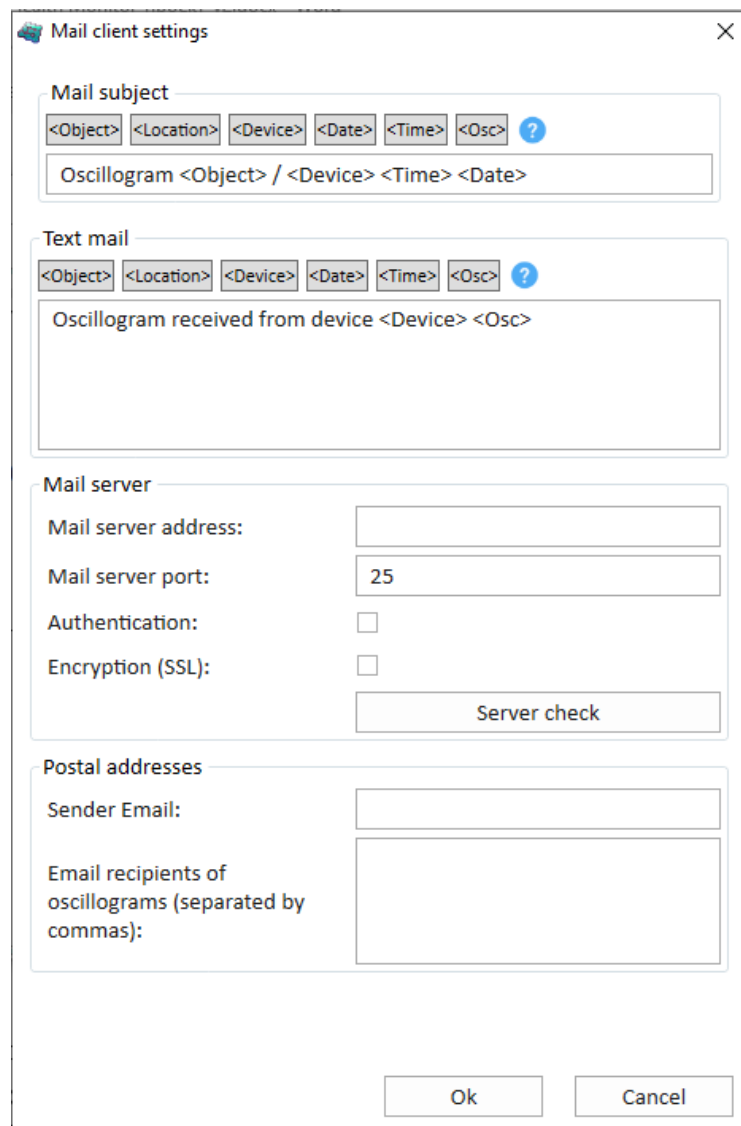

Figure 266 – **Mail client settings** window

The description of parameters of the **Mail client settings** window is given in table 162.

Table 162 – Description of mail client settings

Parameter	Description
Subject	Subject of the e-mail to be sent in the format <Object>/<Device> <Time> <Date> Allowed tags: <Object> – <Object name>; <Location> – <Installation location>; <Device> – <Device name>; <Date>; <Time>; <Osc> – <Name of disturbance record>
Text	Text of the message informing about the disturbance record
Mail server	
Mail server address:	Mail server address is configured for each device individually. The data is requested from the administrator of the organization's mail server
Mail server port:	Port on which the mail server is running. The data is requested from the mail server administrator
Authentication:	Authentication (user data and password are entered)
Encryption (SSL):	Using encryption when sending e-mail messages. The data is requested from the mail server administrator
Server check	Checking server operation (it is recommended to perform this operation after editing the mail client settings)
Mail addresses	
E-mail of sender:	String for entering the e-mail address of the sender
E-mail of recipients of disturbance records (separated by commas):	String for entering the email address of the recipient(s)

2) Add a connection  (figure 267).

The command allows you finding devices in the local network. When you select a command, a list of available devices is displayed.

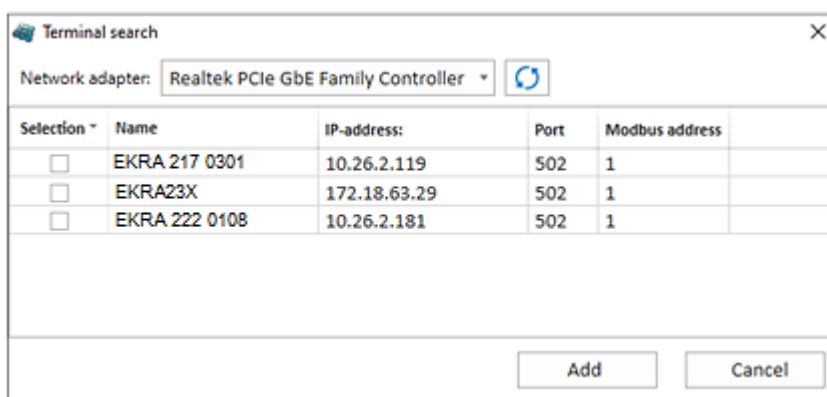

Figure 267 – IED search window

Multiple devices can be selected from the list by checking the boxes in the **Select** column. It is also possible to select all IEDs or deselect all by clicking on the title of the **Select** column.

If necessary, you can connect or disconnect all added devices. To do this, right-click the mouse and select **Connect all** or **Disconnect all** from the context menu of the object tree (figure 268).

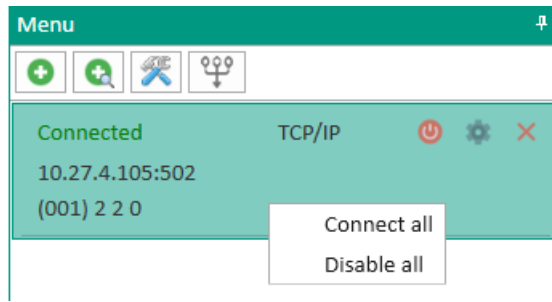

Figure 268 – Context menu of the tree of objects

3) Settings of the program  (figures 269 – 271).

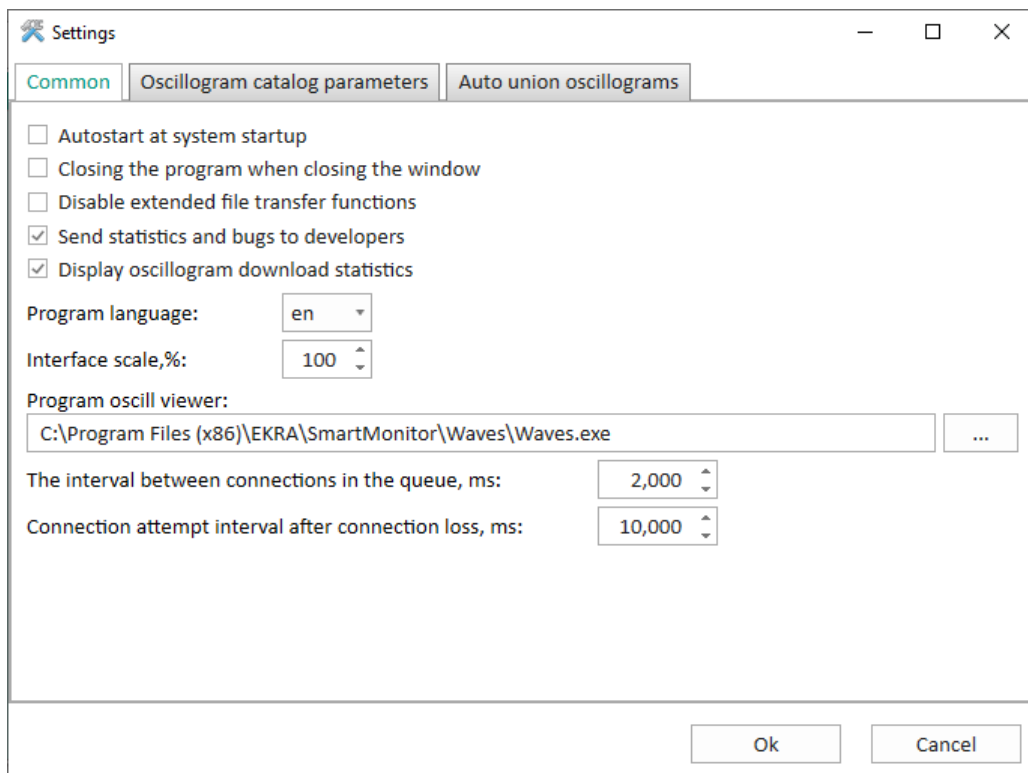

Figure 269 – General settings of the program

The description of general settings of the program (Figure 269) is given in table 163.

Table 163 – Description of general settings of the program

Parameter	Description
Autostart at system start	Checked box indicates an automatic start of the program at system start
Shutdown program when closing window	Selected box indicates that the program will be shutdown when closing the window. If this box is not checked, the program will be hidden in the system tray
Disable advanced Modbus file transfer features	Checked box indicates that advanced features of file transfer via Modbus are disabled
Send statistics and errors to developers	Checked box allows sending statistics and program errors to developers
Display disturbance record download statistics	Checked box indicates the display of disturbance record download statistics
Program language:	Selecting the program language from the drop-down list: - ru; - en
Interface scale, %:	Setting the interface scale

Parameter	Description
Disturbance record viewer:	Path to disturbance record viewer
Interval between connections in queue, ms:	Set the interval between connections in the queue in milliseconds
Connection retry interval after connection loss, ms:	Set connection retry interval after connection loss in milliseconds

The **Dist. record directory parameters** tab (Figure 270) allows you to configure the template of the directory for saving disturbance records downloaded from devices. Configuration consists of selecting a base directory, defining a directory tree hierarchy, defining the method for constructing the “Device location” node, and defining the method for constructing the “Start date” node. The location of the default base directory is determined by the operating system to store application data. Changing the settings changes the display of this template.

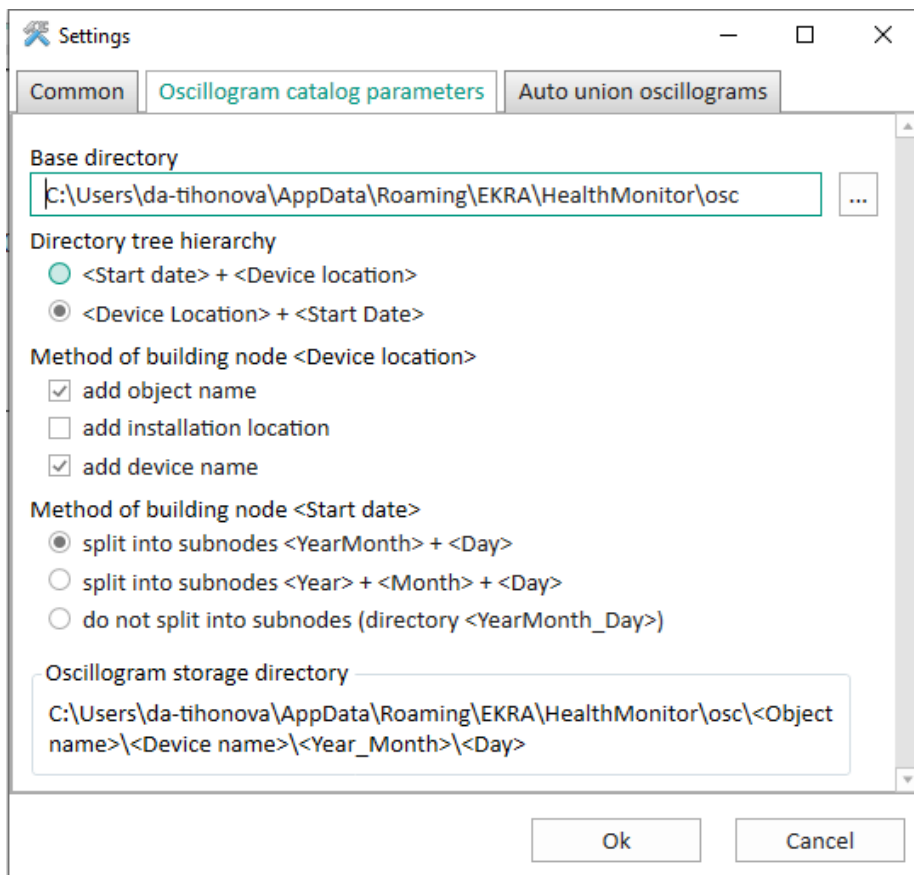

Figure 270 – **Dist. record directory parameters** tab

The description of disturbance record directory parameters is given in table 164.

Table 164 – Description of general settings of the program

Parameter	Description
Base directory	Path of the base directory
Directory tree hierarchy	Selecting the directory tree hierarchy: – <Start date>+<Device location>; – <Device location>+<Start date>

Parameter	Description
<Device location> node construction method	Selecting the method for constructing the <Device location> node (multiple positions can be selected): <ul style="list-style-type: none"> – add the name of the object; – add the location for installation; – add the name of the device
<Start date> node construction method	Selecting the method for constructing the <Start date> node: <ul style="list-style-type: none"> – split into subnodes <YearMonth>+<Day>; – split into subnodes <Year>+<Month>+<Day>; – do not split into subnodes (<YearMonth_Day> directory)
Disturbance record storage directory	Displaying the storage path of disturbance records by selected parameters

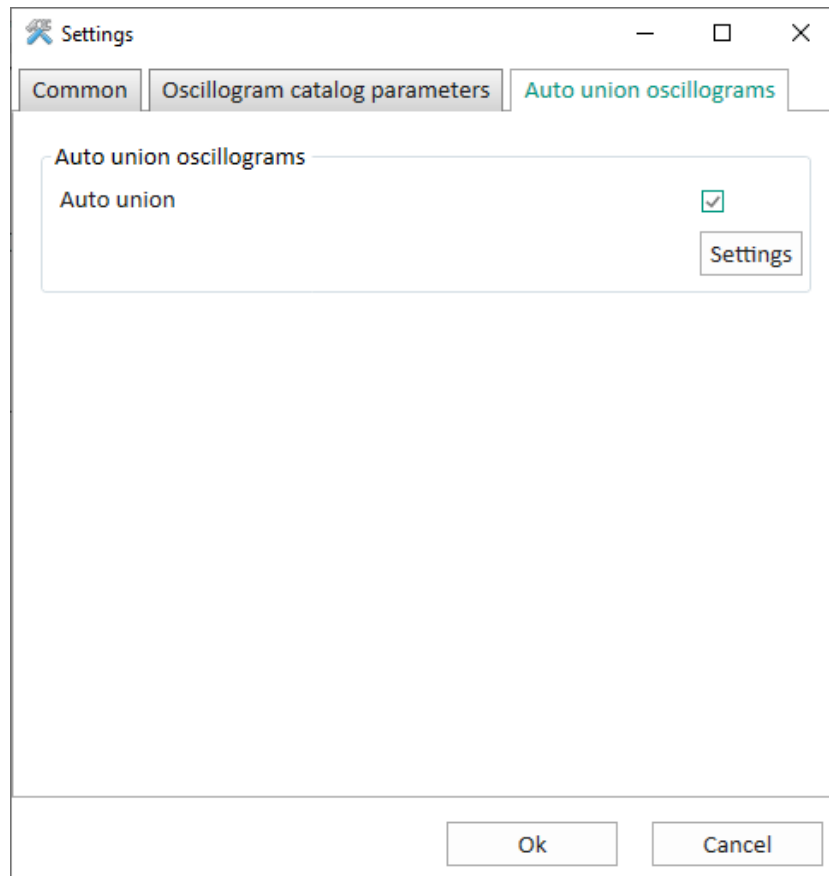

Figure 271 – Dist. records auto merge tab

The **Dist. records auto merge** tab is designed to merge disturbance records that belong to the same event into a single disturbance record according to a specified template. The checked box enables automatic merging of disturbance records.

To set automatic merging of disturbance records press the **Settings** button.

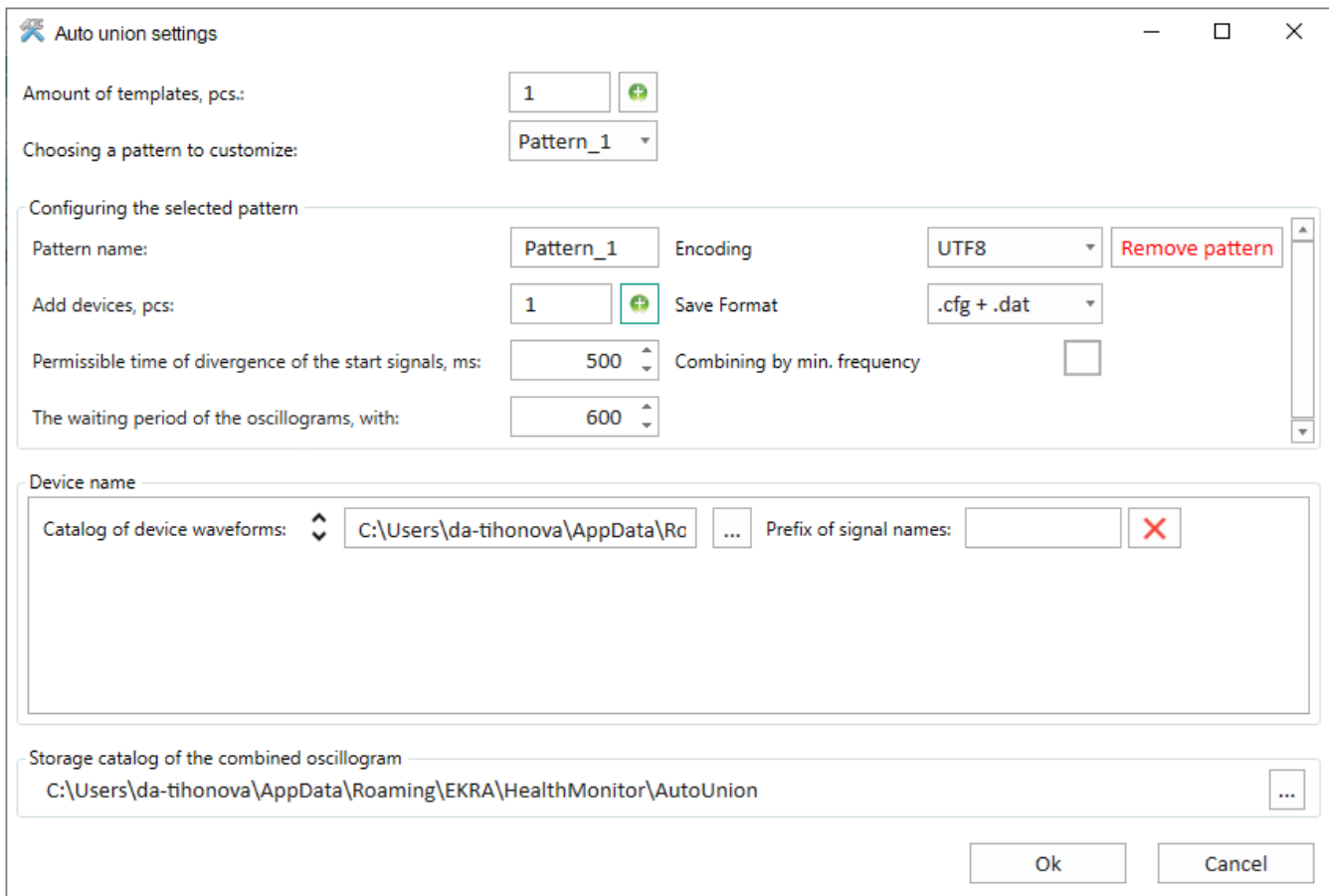

Figure 272 – Auto merge settings window

The description of parameters of the **Auto merge settings** window (Figure 272) is given in table 165.

Table 165 – Description of parameters of the **Auto merge settings** window

Parameter	Description
Template count, pcs:	Number of templates added
Select setting template:	Selecting created templates from the drop-down list: – Template_1; – Template_2; – Template_3, etc.
Setting selected template	
Template name:	Name for the selected template
Add devices, pcs:	Adding a device for the selected template in the range of values 1 to 999
Permissible start signal divergence time, ms:	Permissible range of values is 0 to 5,000 ms in 1 ms increments
Disturbance record wait period, s:	Permissible range of values is 10 to 86,400 s in 1 s increments
Encoding	Encoding for saving disturbance records from the drop-down list: – UTF8; – Windows1251; – OEM866
Save format	Saving merged disturbance records in COMTRADE format from the drop-down list: – .cfg + .dat; – cff
Merge by min. frequency	Checked box allows merging of disturbance records by the minimum frequency. For merging, the program selects the minimum sample frequency of converted disturbance records, which is applied to all disturbance records

Parameter	Description
Devices	List of added devices
Disturbance record directory 1, 2, 3...	Directory of the selected disturbance record
Signal name prefix	Possibility to add a corresponding prefix in front of the names of signals in the merged disturbance record to identify signals of the same name from different devices
Merged disturbance record storage directory	Directory with merged disturbance records

The user manually sets one or more templates for the operation of the automatic disturbance record merging function (hereinafter referred to as the function). Each template specifies the directories that receive disturbance records in COMTRADE format from RPA devices. The function checks the directories specified in the templates for new disturbance records from the moment the function is enabled.

When new disturbance records appear, the function extracts the start date and time (start label) from each disturbance record. Based on the received start labels, which are included in the range of the “Permissible start signal divergence time” parameter, the function determines the list of disturbance records for subsequent merging. Merging of disturbance records is carried out immediately after finding all the disturbance records in the directories that belong to one event, or after the “Disturbance record wait period” time has elapsed (when two or more disturbance records are found).

4) Manual merge (figure 273).

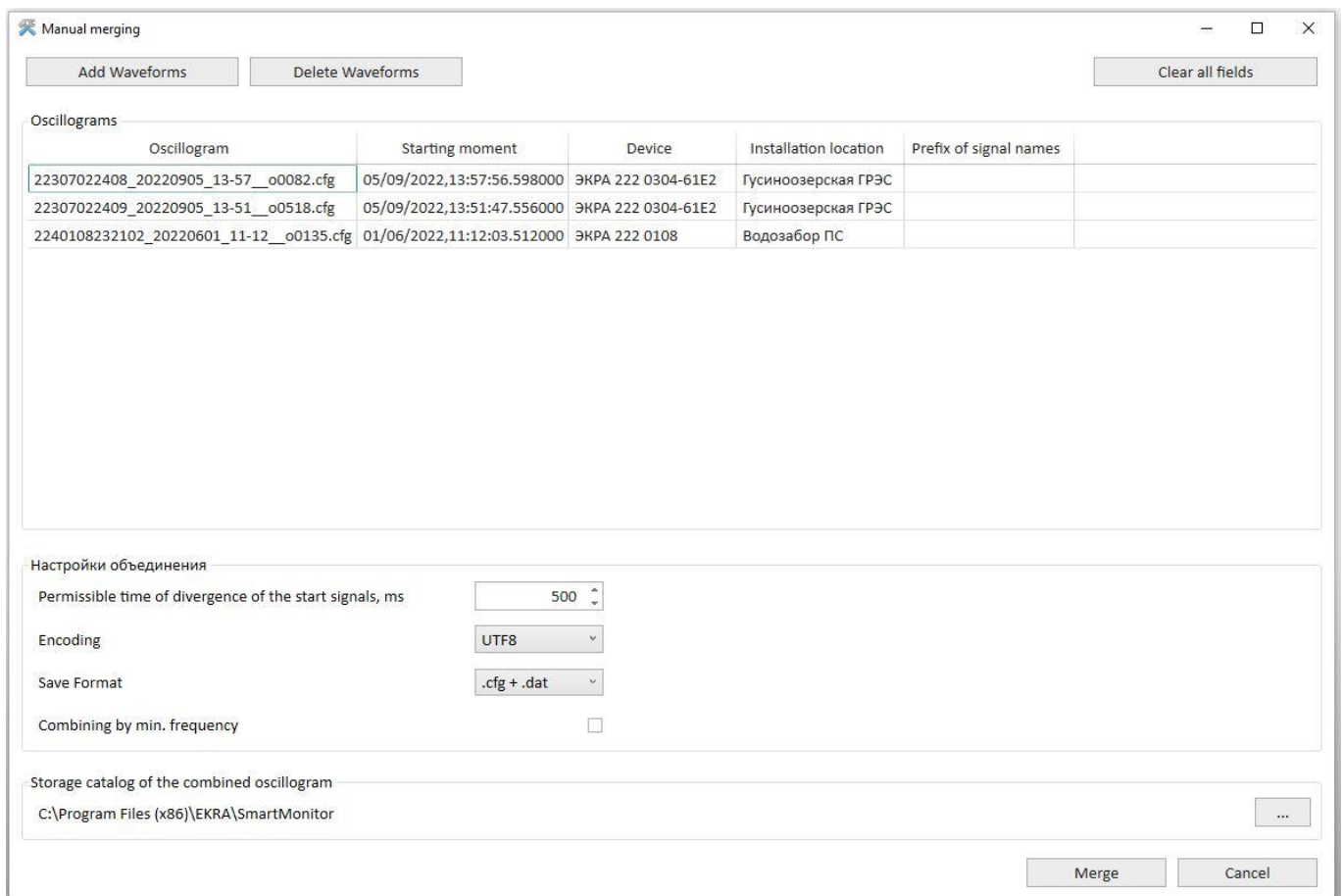

Figure 273 – Dist. records manual merge window

The description of parameters of the **Manual merge** window is given in table 166.

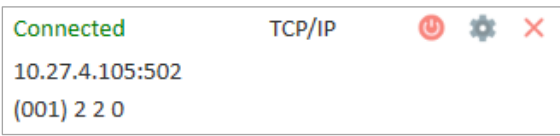

Table 166 – Parameters of the **Manual merge** window





Parameter	Description
Add disturbance records	Adding a disturbance record file
Clear selected fields	Clearing selected fields
Clear all fields	Clearing all fields
Disturbance records	
Disturbance record	Disturbance record file name
Start moment	Date and time of disturbance record start
Device	Device name
Installation location	Object of power industry
Signal name prefix	Possibility to add a corresponding prefix in front of the names of signals in the merged disturbance record to identify signals of the same name from different devices
Merge settings	
Permissible start signal divergence time, ms	Permissible range of values is 0 to 5,000 ms in 1 ms increments
Encoding	Encoding for saving disturbance records from the drop-down list: – UTF8; – Windows1251; – OEM866
Save format	Format for saving merged disturbance records from the drop-down list: – .cfg + .dat; – cff
Merge by min. frequency	Checked box allows merging by the minimum frequency
Merged disturbance record storage directory	Location of the directory with merged disturbance records

Each device has its own toolbar.

Possible device connection states are given in table 167.





Table 167 – Device connection states

Command	Description
	Possible connection errors: – TCP/IP is not installed; – IP address of the PC is not specified when setting the TCP/IP protocol on the local PC; – device is not available (turned off or not connected to the local network)
	Device is connected
	Reconnecting the device
Lost connection	The device is not available (problems in the local network or the device is disconnected from the network)

Command	Description
 TCP/IP    10.26.1.181:502 (001) KP ШЭ11111-152GT-27E 1	

The description of the device toolbar commands is given in table 168.

Table 168 – Description of the device toolbar

Command	Description
 Connect	Reconnecting the device
 Disconnect	Disconnecting the device
 Settings	Editing general device settings, auto-download of disturbance records
 Remove	Removing the device from the list

5.4 Messages to operator

At program start and execution stages errors may appear. The reasons for such situations can be incorrect user actions, incorrect program setting, incorrect configuration of the operating environment. As a rule, the program itself detects errors and if possible troubleshoots them autonomously, otherwise the user will be provided with detailed information about the error and its troubleshooting.

This section provides a description of the most common errors, indicating the messages generated by the program, and ways of troubleshooting.

When establishing a connection with the device, an error situation may occur for several reasons:

- 1) the OS does not have the Modbus TCP/IP protocol installed. In this case, you need to close the program, open the **Control Panel**, select the **Network** shortcut and install the Modbus TCP/IP protocol;
- 2) it may turn out that the PC at the specified name or IP address is found, but the PC is using a different TCP port than that specified in the program. In this case, you need to determine which TCP port is used to connect to the program.

If there are any difficulties, you should contact the administrator of the local network of the enterprise.

Annex A

Logical elements and their designation

Main logical elements used to configure the IED, their principle of operation and purpose are shown in table A.1. The operation principle is shown on the example of truth tables or timing diagrams.

Table A.1 – Main logical elements

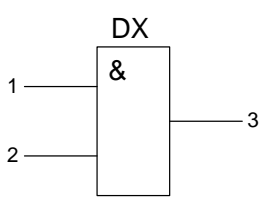
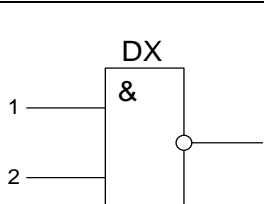
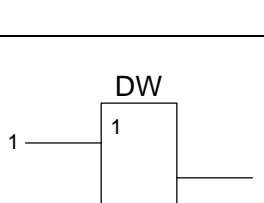
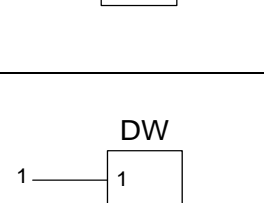
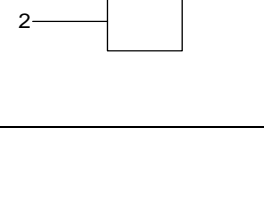
Logical element	Name	Description	Operation principle			Notes
			Input 1	Input 2	Output	
	DX _i , where i is element number	Logical AND	0	0	0	Logical element that performs the function of logical multiplication. There will be one at the output only when one appears at all inputs. Number of element inputs cannot exceed 30. It has no settings
			0	1	0	
			1	0	0	
			1	1	1	
	DX _i , where i is element number	Logical AND – NO	0	0	1	Logical element that works like an AND element, but with an inverted output signal. There will be one at the element output when zero appears at one of its inputs. Number of element inputs cannot exceed 30. It has no settings
			0	1	1	
			1	0	1	
			1	1	0	
	DW _i , where i is element number	Logical OR	0	0	0	Logical element that performs the function of logical addition. There will be one at the element output when one appears at least at one of its inputs. Number of element inputs cannot exceed 30. It has no settings
			0	1	1	
			1	0	1	
			1	1	1	
	DW _i , where i is element number	Logical OR – NO	0	0	1	Logical element that works like an OR element, but with an inverted output signal. There will be one at the element output only when zeros appear at all inputs. Number of element inputs cannot exceed 30. It has no settings
			0	1	0	
			1	0	0	
			1	1	0	
	XOR _i , where i is element number	Logical Exclusive OR	0	0	0	Logical element that generates one at the output, if there is one, at least at one of the inputs, when one appears at both inputs, a zero signal is generated at the output. This element always has exactly two inputs. It has no settings
			0	1	1	
			1	0	1	
			1	1	0	

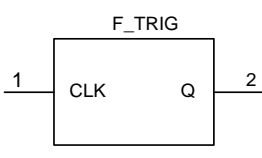
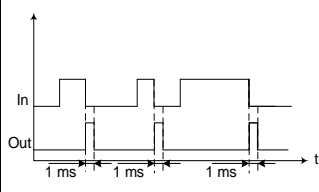
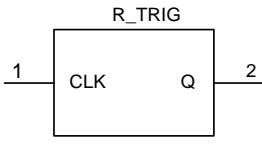
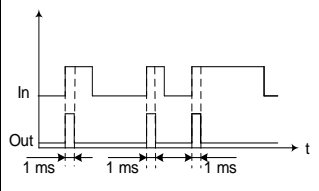
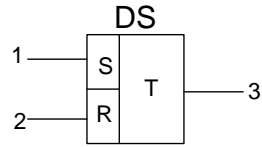
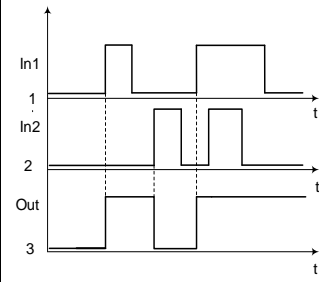
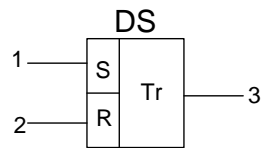
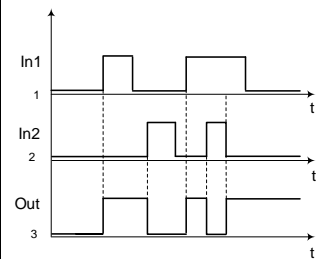
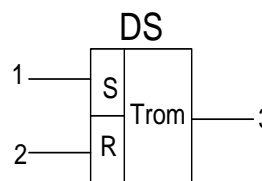
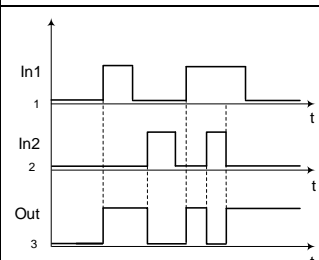
Logical element	Name	Description	Operation principle	Notes
	F_TRIG _i , where i is element number	Determining falling edge		<p>Logical element is designed to determine switching of the signal at the element input from "1" to "0" and issue a pulse at the output.</p> <p>If the CLK signal changes at the F_TRIG element input from "1" to "0", a pulse with duration of 1 ms is generated at output Q.</p> <p>It has no settings</p>
	R_TRIG _i [*] , where i is element number	Determining rising edge		<p>Logical element is designed to determine switching of the signal at the element input from "0" to "1" and issue a pulse at the output.</p> <p>If the CLK signal changes at the R_TRIG element input from "0" to "1", a pulse with duration of 1 ms is generated at output Q.</p> <p>It has no settings</p>
	DS _i , where i is element number	RS trigger with S priority		<p>Logical element that has the ability to stay in one of two stable states for a long time. Designed to record and store information.</p> <p>If there is one at input S (set), one appears at the output, regardless of the signal at input R. The trigger remembers the signal and holds it. When S=0, the presence of one at input R (reset) sets the output to state 0.</p> <p>It has no settings. With R=1 and S=1 there will be "1" at the output</p>
	DS _i , where i is element number	RS trigger with R priority		<p>Logical element that has the ability to stay in one of two stable states for a long time. Designed to record and store information.</p> <p>With R=0, when one arrives at input S (set), one appears at the output. The trigger remembers the signal and holds it. When one appears at input R (reset), the output signal is reset, regardless of the signal at input S.</p> <p>It has no settings. With R=1 and S=1 there will be "0" at the output</p>
	DS _i , where i is element number	Non-volatile RS trigger with R priority		<p>Logical element maintaining its state when the operating power supply of the IED is turned off and recovering when the power supply is restored.</p>

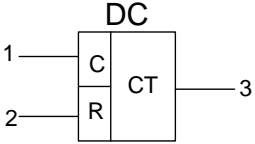
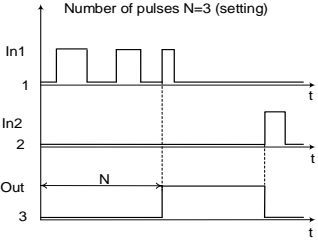
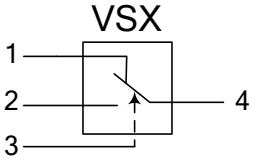
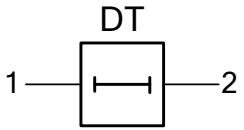
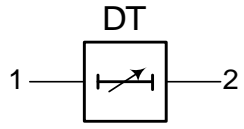
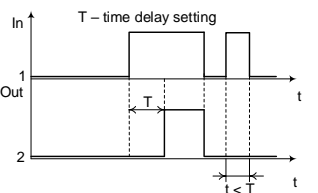
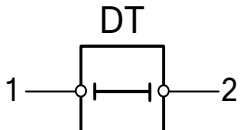
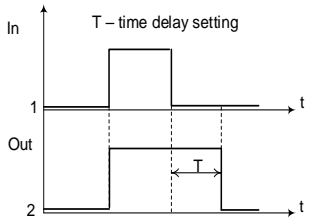
Logical element	Name	Description	Operation principle	Notes																																				
				The principle of operation is similar to the operation principle of the trigger with R priority. It has no settings. With R=1 and S=1 there will be "0" at the output																																				
	DC _i , where i is element number	Pulse counter		Logical element that counts pulses received at input C. When the number of pulses N, specified by the setting, is exceeded, one is generated at the counter output and is held until a reset signal is received at input R (reset). If the reset signal appears before operate setting is reached, the counted number of pulses is reset, and the count starts again. The value of counter setting is within the range from 1 to 9,999.000 pulses																																				
	VSX _i , where i is element number	Input switch	<table border="1" data-bbox="726 891 1045 1433"> <thead> <tr> <th>Input 1</th> <th>Input 2</th> <th>Input 3</th> <th>Output</th> </tr> </thead> <tbody> <tr><td>0</td><td>0</td><td>0</td><td>0</td></tr> <tr><td>1</td><td>0</td><td>0</td><td>1</td></tr> <tr><td>1</td><td>0</td><td>1</td><td>0</td></tr> <tr><td>0</td><td>1</td><td>0</td><td>0</td></tr> <tr><td>0</td><td>0</td><td>1</td><td>0</td></tr> <tr><td>1</td><td>1</td><td>0</td><td>1</td></tr> <tr><td>0</td><td>1</td><td>1</td><td>1</td></tr> <tr><td>1</td><td>1</td><td>1</td><td>1</td></tr> </tbody> </table>	Input 1	Input 2	Input 3	Output	0	0	0	0	1	0	0	1	1	0	1	0	0	1	0	0	0	0	1	0	1	1	0	1	0	1	1	1	1	1	1	1	Logical element containing three inputs and one output and having an option to switch between two inputs by the signal of the third input. When the signal of input 3 is zero, output signal equals to the signal at input 1, and when the signal of input 3 is one, output signal equals to the signal at input 2. It has no settings
Input 1	Input 2	Input 3	Output																																					
0	0	0	0																																					
1	0	0	1																																					
1	0	1	0																																					
0	1	0	0																																					
0	0	1	0																																					
1	1	0	1																																					
0	1	1	1																																					
1	1	1	1																																					
 	DT _i , where i is element number	Operate time delay (non-adjustable) Operate time delay (adjustable)		Logical element that delays the signal. Time delays are divided into adjustable and non-adjustable. The value of adjustable time delay is editable in the range from 0 to 9,999.000 s, the change step is 1 ms. The value of non-adjustable time delay is not editable																																				
	DT _i , where i is element number	Reset time delay (non-adjustable) Reset time delay (adjustable)																																						

Logical element	Name	Description	Operation principle	Notes
	TMOC _i , where i is element number	Pulse former		<p>Logical element that generates an output pulse with a duration of T, determined by the setting, when the state at the input changes from zero to one.</p> <p>The value of time delay for these elements is within the range from 0.001 to 9,999.000 s, the change step is 1 ms</p>
	TMOI _i , where i is element number	Pulse former with interruption		<p>Logical element that generates an output pulse with a duration of T, determined by the setting, when the state at the input changes from zero to one. The output is reset to logical "0" if the input is set to "0" before the end of the pulse.</p> <p>The value of time delay for these elements is within the range from 0.001 to 9,999.000 s, the change step is 1 ms</p>
	Gen _i , where i is element number	Rectangular pulse generator		<p>Logical element that generates pulses with a duration of t in the presence of a signal at the input. It has two settings: T signal period and t pulse duration.</p> <p>The signal period is in the range from 0 to 27 s, the change step is 1 ms. The pulse duration is always less than the signal period</p>
	VXN _i , where i is element number	Program switch	Changeable parameter determined when specifying the settings	It can take two values: opened ("0"), closed ("1")

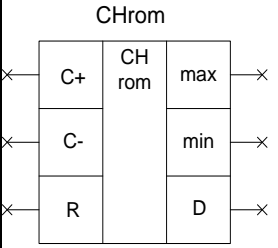
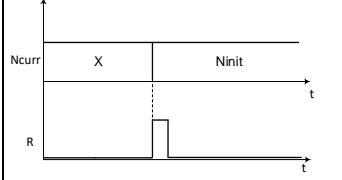
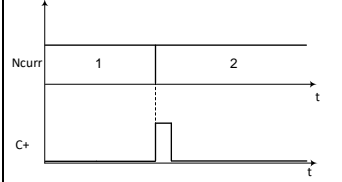
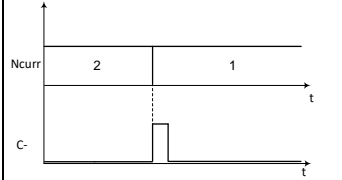
Logical element	Name	Description	Operation principle	Notes
	<p>CHromi, where i is ele- ment number</p>	<p>Counter of OLTC drive steps</p>	<p>Counted by adding ($N_{curr}=N_{curr}+1$) (subtracting ($N_{curr}=N_{curr}-1$)) with each appearance of adjustment signal "Add (C+)" ("Subtract (C-)"). Counted relative to the initial value of the OLTC step (Ninit) specified by the user. When the maximum (Nmax) (minimum (Nmin)) step is reached, the "Maximum step" (max) ("Minimum step" (min)) signal is generated.</p> <p>It is possible to determine "dead" OLTC steps – steps which the OLTC drive skips without adjustment. The numbers of "dead" step are specified using settings. When the number of the current step (Ncurr) is equal to the number of the dead step, the "Dead step" (D) signal is generated.</p> <p>Ncurr – state of step counter X – previously formed step R signal "return to initial step"</p>  <p>C+ signal "add"</p>  <p>C- signal "subtract"</p>  <p>State of logic outputs for settings: Minimum step 2 Dead steps 5 Maximum step 7</p>	<p>Logical element designed to determine the number of the current step and issue blocking commands in case of reaching the maximum and minimum OLTC steps. It is possible to determine the "dead" steps.</p> <p>It has the following settings:</p> <ul style="list-style-type: none"> - Maximum value of OLTC step ($N_{max} = 1 \dots 64, N_{max} \geq N_{min}$); - Minimum value of OLTC step ($N_{min} = 1 \dots 64, N_{max} \geq N_{min}$); - Initial value of OLTC step ($N_{init} = 1 \dots 64, N_{min} \leq N_{init} \leq N_{max}, N_{max} \geq N_{min}$); - List of dead step (from range $N_{min} \dots N_{max}$)

Logical element	Name	Description	Operation principle	Notes
Cnst 	Cnst _i , where i is element number	Constant "1"		Logical element, at the output of which there is always a logical one
Cnst 	Cnst _i , where i is element number	Constant "0"		Logical element, at the output of which there is always a logical zero
	-	Transfer (connector)	Provides a logical connection between elements	It has no settings